

COBRA[®]

Static Oven Range

Models:

CR6 (600mm)

CR9 (900mm)



INSTALLATION AND OPERATION MANUAL

MANUFACTURED BY

Moffat Limited
Rolleston 7675
New Zealand

INTERNATIONAL CONTACTS

AUSTRALIA

Moffat Pty Limited

E.Mail: vsales@moffat.com.au
Main Office: (tel): +61 (03) 9518 3888
(fax): +61 (03) 9518 3833
Service: (tel): 1800 622 216
Spares: (tel): 1800 337 963
Customer Service: (tel): 1800 335 315
(fax): 1800 350 281

CANADA

Serve Canada

Web: www.servecanada.com
E.Mail: info@servecanada.com
Sales: (tel): 800 551 8795 (Toll Free)
Service: (tel): 800 263 1455 (Toll Free)

NEW ZEALAND

Moffat Limited

Web: www.moffat.co.nz
E.Mail: sales@moffat.co.nz
Main Office: (tel): 0800 663328

UNITED KINGDOM

Blue Seal

Web: www.blue-seal.co.uk
E.Mail: sales@blue-seal.co.uk
Sales: (tel): +44 121 327 5575
(fax): +44 121 327 9711
Spares: (tel): +44 121 322 6640
(fax): +44 121 327 9201
Service: (tel): +44 121 322 6644
(fax): +44 121 327 6257

UNITED STATES

Moffat

Web: www.moffat.com
Sales: (tel): 1800 551 8795 (Toll Free)
(tel): +1 336 661 1556
(fax): +1 336 661 9546
Service: (tel): 866 673 7937 (Toll Free)
(tel): +1 366 661 1556
(fax): +1 336 661 1660

REST OF WORLD

Moffat Limited

Web: www.moffat.co.nz
E.Mail: export@moffat.co.nz

The reproduction or copying of any part of this manual by any means whatsoever is strictly forbidden unless authorized previously in writing by the manufacturer.

In line with policy to continually develop and improve its products, Moffat Ltd. reserves the right to change the specifications and design without prior notice.

© Copyright Moffat Ltd. April 2019.

Contents

CR6 Gas Static Oven Ranges (600mm Wide).

CR9 Gas Static Oven Ranges (900mm Wide).

Part 1	Introduction	2
Part 2	Specifications	3
	Model Numbers Covered in this Specification	
	General	
	Gas Supply Requirements	
	Gas Connection	
	Dimensions	
Part 3	Installation.....	6
	Installation Requirements	
	Unpacking	
	Assembly	
	Location	
	Clearances	
	Gas Connection	
	Commissioning	
Part 4	Operation.....	9
	Operation Guide	
	Description of Controls	
	Open Burners	
	Griddle	
	Oven	
Part 5	Cleaning and Maintenance	12
	General	
	After Each Use	
	Daily Cleaning	
	Weekly Cleaning	
	Periodic Maintenance	
Part 6	Fault Finding.....	15
	Open Burners	
	Griddle Burners	
	Oven	
Part 7	Gas Conversion.....	19
	Gas Conversion Procedure	
	Gas Specifications	
Part 8	Replacement Parts List.....	24

Part 1 Introduction

We are confident that you will be delighted with your **Cobra Series** Ranges, and it will become a most valued appliance in your commercial kitchen.

To ensure you receive the utmost benefit from your new **Cobra Series** Appliance, there are two important things you can do.

Firstly:

Please read this instruction book carefully and follow the directions given. The time taken will be well spent.

Secondly:

If you are unsure of any aspect of the installation, instructions or performance of your appliance, contact your **Cobra Series** Range dealer promptly. In many cases a phone call could answer your question.

WARNING:

IMPROPER INSTALLATION, ADJUSTMENT, ALTERATION, SERVICE OR MAINTENANCE CAN CAUSE PROPERTY DAMAGE, INJURY OR DEATH. READ THE INSTALLATION, OPERATING AND MAINTENANCE INSTRUCTIONS THOROUGHLY BEFORE INSTALLING OR SERVICING THIS APPLIANCE.

WARNING:

INSTRUCTIONS TO BE FOLLOWED IN THE EVENT THE USER SMELLS GAS ARE TO BE POSTED IN A PROMINENT LOCATION. THIS INFORMATION SHALL BE OBTAINED BY CONSULTING THE LOCAL GAS SUPPLIER.

WARNING:

GREAT CARE MUST BE TAKEN BY THE OPERATOR TO USE THE EQUIPMENT SAFELY TO GUARD IT AGAINST RISK OF FIRE.

- THE APPLIANCE MUST NOT BE LEFT ON UNATTENDED.
- IT IS RECOMMENDED THAT A REGULAR INSPECTION IS MADE BY A COMPETENT SERVICEMAN TO ENSURE CORRECT AND SAFE OPERATION OF YOUR APPLIANCE IS MAINTAINED.
- DO NOT STORE OR USE GASOLINE OR OTHER FLAMMABLE VAPOURS OR LIQUIDS IN THE VICINITY OF THIS OR ANY OTHER APPLIANCE.
- DO NOT SPRAY AEROSOLS IN THE VICINITY OF THIS APPLIANCE WHILE IT IS IN OPERATION.

CAUTION:

This appliance is;

- For professional use and is to be used by qualified persons only.
- Only qualified service persons are to carry out installation, servicing and gas conversion operations.
- Components having adjustments protected (e.g. paint sealed) by the manufacturer should not be adjusted by the user / operator.
- DO NOT operate the appliance without the legs supplied fitted.

Part 2 Specifications

Model Covered in this Specification -

CR6D[1]	Range	4 Open Burners.
CR6C[1]	Range	2 Burners + 300mm Griddle.
CR6B	Range	600mm Griddle.
CR9D[1]	Range	6 Open Burners.
CR9C[1]	Range	4 Burners + 300mm Griddle.
CR9B[1]	Range	2 Burners + 600mm Griddle.
CR9A	Range	900mm Griddle.

[1] - Open Burner Options;
 - Standard Option.
 F - Flame Failure Protection.

General

A heavy duty, general purpose Gas Range created for compact modular kitchens and available in a 600mm and 900mm wide option. It has a high option Cooktop / Griddle arrangement and is available on adjustable front feet and robust rear rollers. Open Burners have either Standard or with Flame Failure Protection as an option.

Griddles are available in 300mm, 600mm and for the CR9 Gas Static Oven Range, 900mm options and are fitted with pilot, flame failure and piezo ignition as standard.

The CR6 Oven is a 490mm (internal) full width oven fitted with French style opening doors. The oven burner is a 24-26 MJ oven burner and has pilot and flame failure with piezo ignition.

The CR9 Oven is a 780mm (internal) full width oven fitted with French style opening doors. The oven burner is a 28-30 MJ oven burner and has pilot and flame failure with piezo ignition.

The Range has an easy clean stainless steel external finish.

Gas Supply Requirements

- United Kingdom:

		Natural Gas (G20)				Propane (G31)			
		Open Burner (each)	Griddle (each 300mm section)	Oven		Open Burner (each)	Griddle (each 300mm section)	Oven	
				CR6	CR9			CR6	CR9
Heat Input (net)	Nominal	5.0 kW	5.0 kW	6.5 kW	7.5 kW	4.6 kW	5.0 kW	6.0 kW	7.5 kW
	Reduced	1.7 kW	1.5 kW	1.1 kW	2.2 kW	1.5 kW	2.2 kW	1.05 kW	2.3 kW
Gas Rate (net)	Nominal	0.53 m ³ /hr	0.53 m ³ /hr	0.51 m ³ /hr	0.79 m ³ /hr	0.36 kg/hr	0.39 kg/hr	0.47 kg/hr	0.58 kg/hr
	Reduced	0.18 m ³ /hr	0.16 m ³ /hr	0.14 m ³ /hr	0.23 m ³ /hr	0.12 kg/hr	0.17 kg/hr	0.09 kg/hr	0.18 kg/hr
Supply Pressure		20 mbar				37 mbar			
Burner Operating Pressure (*)		10 mbar				28 mbar			
Gas Connection		¾" BSP Male				¾" BSP Male			

NOTE:

- (*) Measure burner operating pressure at manifold test point with two burners operating at 'High Flame' setting.
- NAT, & LPG Only - Operating pressure is ex-factory set and is not to be adjusted, apart from when converting between gasses, if required.
- Refer to 'Gas Conversion and Specifications' section in this manual for further details.

Gas Connection

CR6 Model

Gas supply connection point is located at the rear of the appliance, approximately 130mm from the right hand side, 19mm from the rear and 656mm from the floor and is reached from beneath the appliance. (Refer to the 'Dimensions' below).

For all Appliance Options, gas connection is 3/4" BSP male.

Dimensions

CR6 Model

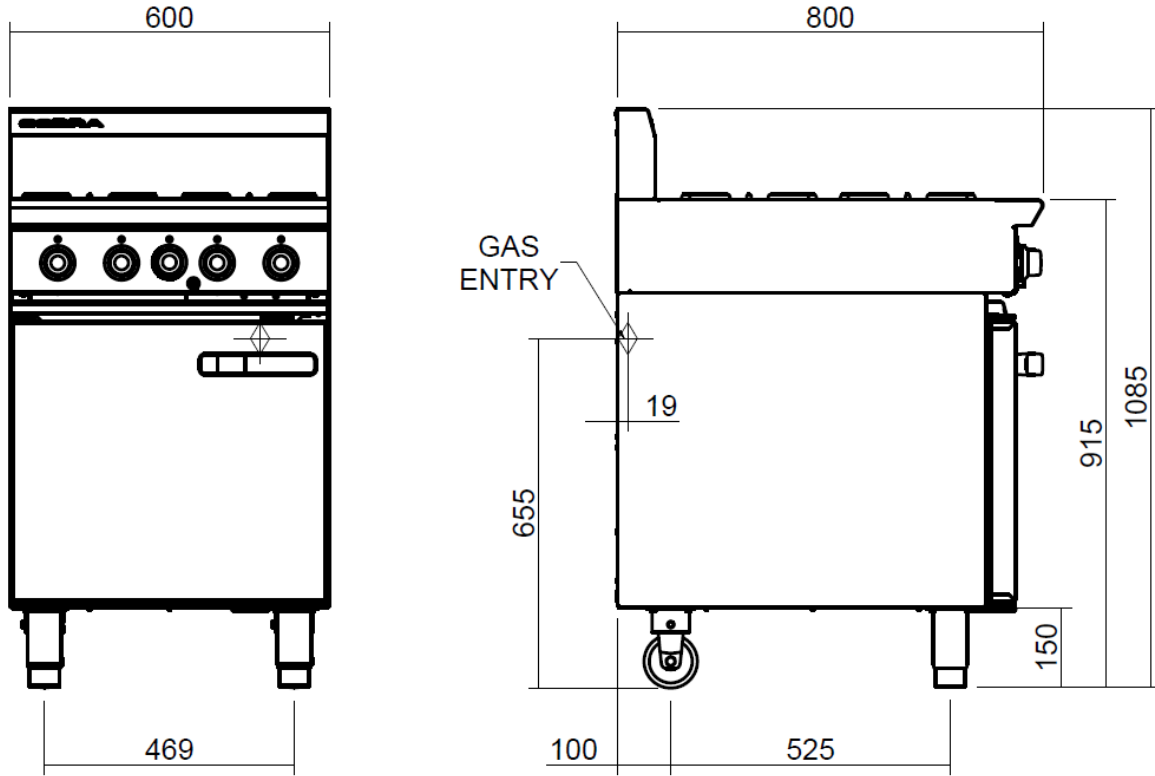

CR6 Model - Cooktop Options

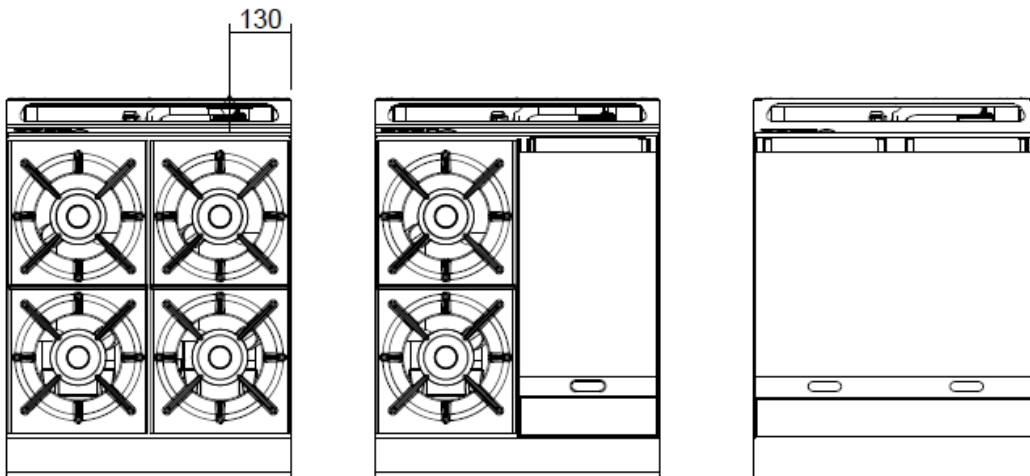

CR6D

CR6C

CR6B

CR9 Model

Gas supply connection point is located at the rear of the appliance, approximately 130mm from the right hand side, 19mm from the rear and 656mm from the floor and is reached from beneath the appliance. (Refer to the 'Dimensions' below).

For all Appliance Options, gas connection is 3/4" BSP male.

Dimensions

CR9 Model

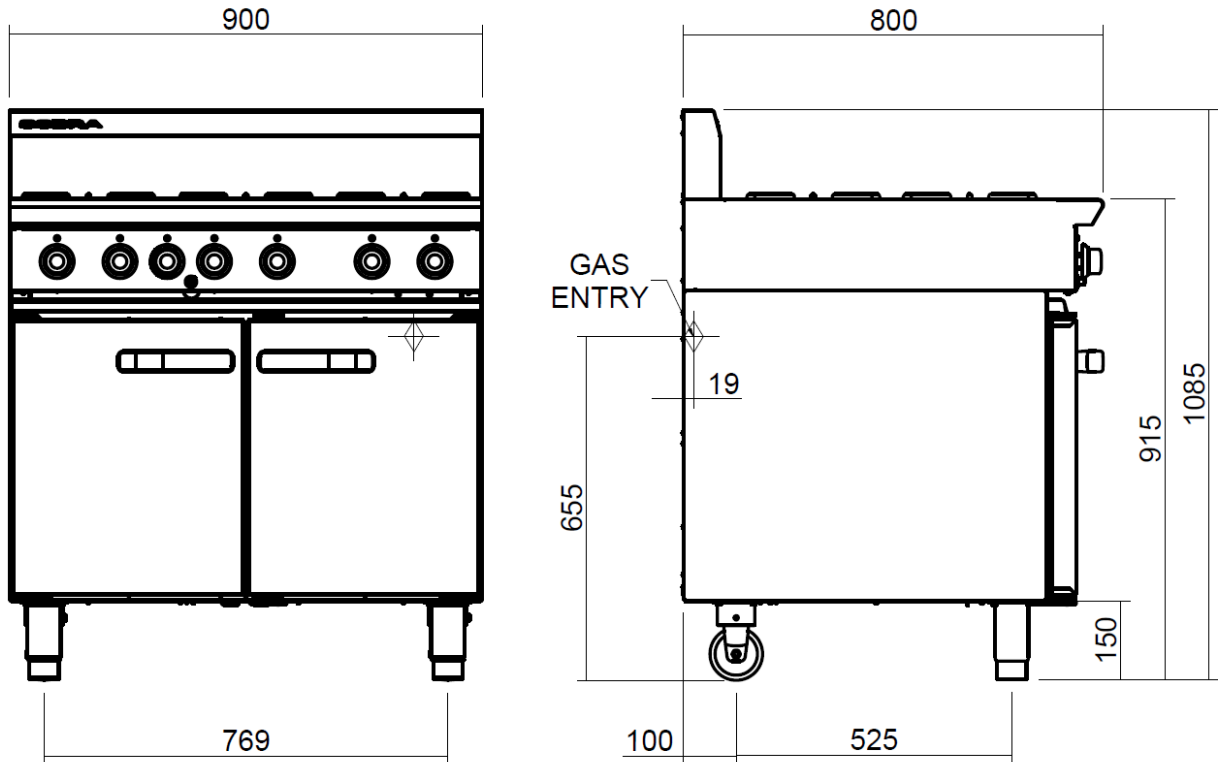

CR9 Model - Cooktop Options

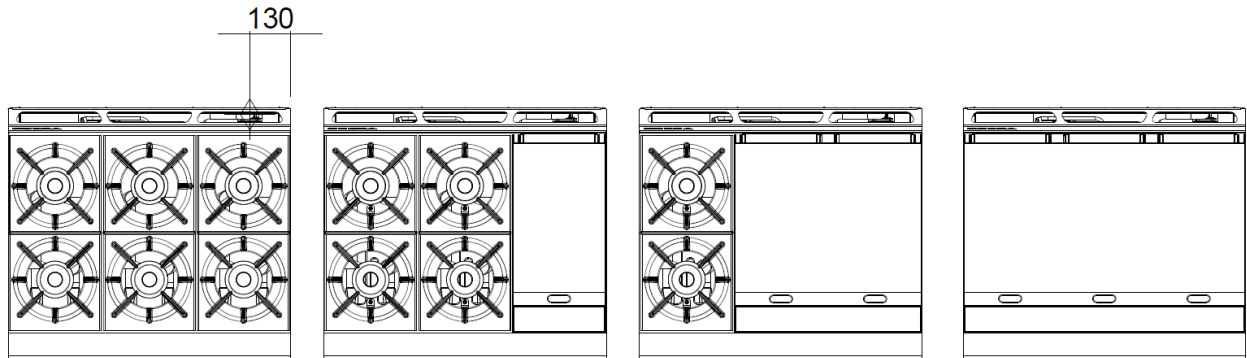

CR9D

CR9C

CR9B

CR9A

Installation Requirements

NOTE:

It is most important that this appliance is installed correctly and that operation is correct before use. Installation shall comply with local, gas and health and safety requirements.

This appliance shall be installed with sufficient ventilation to prevent the occurrence of unacceptable concentrations of health harmful substances in the room that the appliance is installed in.

Cobra Series Ranges are designed to provide years of satisfactory service and correct installation is essential to achieve the best performance, efficiency and trouble-free operation. This appliance must be installed in accordance with National installation codes and in addition, in accordance with relevant National / Local codes covering gas and fire safety.

United Kingdom:

Gas Safety (Installation and Use) Regulations 1998.
BS6173 - Installation of Catering Appliances.
BS5440 1 & 2 - Installation Flueing & Ventilation.

Ireland:

IS 820 - Non Domestic Gas Installations.

Installations must be carried out by qualified service persons only. Failure to install equipment to the relevant codes and manufacturer's specifications shown in this section will void the warranty.

Components having adjustments protected (e.g. paint sealed) by manufacturer, are only to be adjusted by a qualified service agent. They are not to be adjusted by the installation person.

Unpacking

- Remove all packaging and transit protection from the appliance including all protective plastic coating from the exterior stainless steel panels.
- Check equipment and parts for damage. Report any damage immediately to the carrier and distributor.
- Report any deficiencies to the distributor who supplied the appliance.
- Check that the available gas supply is correct to that shown on the rating plate located on the front lower corner of the R/H side panel.

Assembly

If the Legs and Rear Rollers are not fitted, carry out the procedure below to fit Front Legs and Rear Rollers.

NOTE:

This appliance is fitted with adjustable feet to enable the appliance to be positioned securely and level. This should be carried out on completion of the gas connection.

Fitting Front Legs and Rear Rollers.

1. Remove all loose components from the top of the cooktop range and from inside the oven.
2. Remove screws securing transit plates to the front corners of the transit pallet.

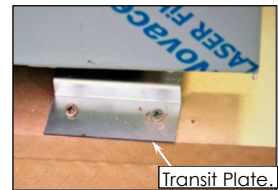

3. Tilt the oven onto its back and unscrew the transit bolts from the front leg mounting plates.

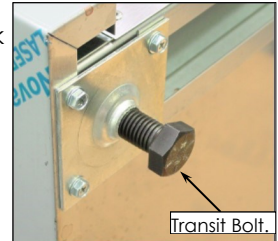

4. Remove front legs from carton and screw onto the front leg mounting plates.



NOTE:

The front legs are adjustable. Once the rear rollers are fitted and the appliance is in its operating position, the front legs can be adjusted to level the appliance.

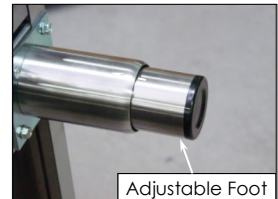

5. Remove rear rollers from carton and attach to rear leg ring plate. Secure with 10mm bolts supplied.



6. Lift appliance back onto its legs / rollers.
7. Place the cooktop in its final operating position and use the adjustable feet to level the appliance.
8. Refit all items removed at Item 1 above.

Location

1. This appliance must be installed in a suitably ventilated room to prevent dangerous build up of combustion products.
2. Installation must allow for a sufficient flow of fresh air for the combustion air supply.

Combustion Air Requirements		
	CR6 Cooktop	CR9 Cooktop
Natural Gas	30 m ³ /hr minimum	41 m ³ /hr minimum
LPG / Propane	31 m ³ /hr minimum	43 m ³ /hr minimum

3. Never directly connect a ventilation system to the appliance flue outlet.
4. Position the appliance in its approximate working position.
5. All air for burner combustion is supplied from underneath the appliance. The legs must always be fitted and no obstructions placed on the underside or around the base of the appliance, as obstructions will cause incorrect operation and / or failure of the appliance.
6. Components having adjustments protected (e.g. paint sealed) by manufacturer are only to be adjusted by a qualified service agent. They are not to be adjusted by the installation person.

NOTE:

Do not obstruct or block the appliances flue. Never directly connect a ventilation system to the appliance flue outlet.

Clearances

NOTE:

Only non-combustible materials can be used in close proximity to this appliance.

Any gas burning appliance requires adequate clearance and ventilation for optimum and trouble free operation. The following minimum installation clearances are to be adhered to:

	Combustible Surface	Non Combustible Surface
LH / RH Side	250mm (*)	0mm
Rear	100mm	0mm

* Side clearances can be 50mm when adjacent surface is at least 100mm below cooking surface.

Gas Connection

NOTE:

ALL GAS FITTING MUST ONLY BE CARRIED OUT BY A QUALIFIED SERVICE PERSON.

1. **Cobra Series Oven Ranges** do not require an electrical connection, they function totally on the gas supply only.
2. It is essential that the gas supply is correct for the appliance to be installed and that adequate supply pressure and volume are available. The following checks should be made before installation:-
 - a. **The Gas Type** the appliance has been supplied for is shown on coloured stickers located above the gas entry point and next to the rating plate. Check that this is correct for the gas supply the appliance is being installed for. The gas conversion procedure is detailed in the Gas Conversion Instruction Sheet for this appliance.
 - b. **Supply Pressure** required for this appliance is shown in the 'Specifications' section of this manual. Check the gas supply to ensure that adequate supply pressure exists.
 - c. **Input Rate** of this appliance is also shown on the Rating Plate located on the front lower corner of the R/H side panel, and in the 'Specifications' section of this manual. The input rate should be checked against the available gas supply line capacity. **Particular note should be taken if the appliance is being added to an existing installation.**

NOTE:

It is important that adequately sized piping runs directly to the connection joint on the appliance, with as few tees and elbows as possible to give maximum supply volume.

3. Fit the gas regulator supplied, into the gas supply line as close to the appliance as possible.

NOTE:

Gas pressure regulator provided with this appliance is convertible between Natural Gas and LPG as per the 'Gas Conversion Section' in this manual. Ensure the regulator is converted to the correct gas type that the appliance will operate on.

Regulator outlet pressure is fixed ex-factory for the gas type that the regulator is converted to and it is NOT to be adjusted.

The regulator connections are 3/4" BSP female. The connection to the appliance is 3/4" BSP male.

(Refer to the 'Specifications' Section for the gas supply location dimensions).

NOTE:

A Manual Isolation Valve must be fitted to the individual appliance supply line.

4. Correctly locate the appliance into its final operating position and using a spirit level, adjust the legs so that the appliance is level and at the correct height.
5. Connect the gas supply to the appliance. A suitable joining compound which resists the breakdown action of LPG must be used on every gas line connection, unless compression fittings are used.
6. Check all gas connections for leakages using soapy water or other gas detecting equipment.

WARNING:

DO NOT USE A NAKED FLAME TO CHECK FOR GAS LEAKAGES.

7. Check that the gas supply pressure is as shown in the 'Specifications' section, 'Gas Supply Requirements'.

NOTE:

The supply pressure is to be measured at the manifold test point and with 2 burners operating at the 'High Flame' setting.

8. Light the Main Burners. Refer to the 'Operations' Section, 'Open Burners'.
9. Verify that the supply pressure is still correct.
10. Check that the Main Burner is alight and adjust the low fire adjustment screw on the open burner gas control valves to obtain the desired flame size.
11. Check / adjust the main burner aeration gap. This gap should be set to the dimensions shown in the 'Gas Specification Tables' in 'Part 7 - Gas Conversion'.

NOTE:

This appliance is fitted with adjustable feet to enable the appliance to be positioned securely and level. This should be carried out on completion of the gas connection.

Commissioning

The following commissioning checks must be carried out before the Range is handed over for use, to ensure that the unit operates correctly and the operator(s) understand the correct operating procedure.

1. Before leaving the new installation;
 - a. Check the following functions in accordance with the operating instructions specified in the 'Operation' section of this manual.
 - Lighting the Griddle.
 - Lighting the Open Burners. (Standard or with Flame Failure Option).
 - Check the Low Fire Burner Operation.
 - Light the Oven Pilot and Main Burners.
 - Check the Oven Main Burner Thermostat operation.
 - Turning the Oven to 'Stand-By' Mode.
 - Oven 'Shut Down'.
 - b. Ensure that each operator has been instructed in the areas of correct lighting, operation, and shutdown procedure for the appliance.
2. This manual must be kept by the owner for future reference and a record of the **Date of Purchase**, **Date of Installation** and **Serial Number of the Appliance** recorded and kept with this manual. (These details can be found on the Rating Plate rating plate located on the front lower corner of the R/H side panel.

NOTE:

If it is not possible to get the appliance to operate correctly, shut 'Off' the gas supply and contact the supplier of this unit.

Operation Guide

CAUTION:

- This appliance is for professional use and is only to be used by qualified persons.
- Only qualified service persons are to carry out installation, servicing or gas conversion operations.
- Components having adjustments protected (e.g. paint sealed) by the manufacturer should not be adjusted by the user / operator.

1. **Cobra** appliances have been designed to provide simplicity of operation and 100% safety protection.

2. Improper operation is almost impossible, however bad operation practices can reduce the life of the appliance and produce a poor quality product. To use this appliance correctly please read the following sections carefully:-

- Lighting the Open Burners (Standard or Flame Failure Option).
- Lighting the Griddle.
- Oven Pilot Ignition.
- Oven Main Burner Thermostat.
- Turning the Oven to 'Stand-By' Mode.
- Oven 'Shut Down'.

Description of Controls

(CR9-Gas Range 900mm Option shown)

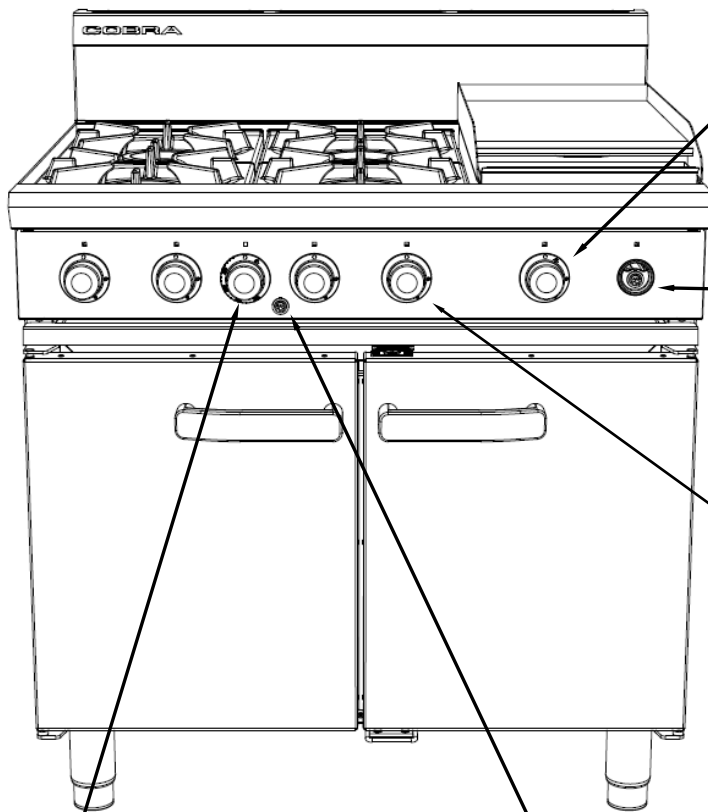

Gas Control Knobs

Griddle.

- OFF Position
- ★ PILOT Burner
- ▲ HIGH Flame
- △ LOW Flame

Piezo Igniter (Griddles Only)

Open Burners (Std / F)

- OFF Position
- ▲ HIGH Flame
- △ LOW Flame
- ▲ Rear Burner
- ▼ Front Burner

(Indicators located above Gas Control Knobs).

Oven Control

- OFF Position
- ★ PILOT Burner

100 - 310°C
Thermostat Settings.

Piezo Igniter (Ovens Only)

Open Burners

NOTE: Only cooking pans from size Ø 150mm to Ø 420mm are suitable for use on these open burners.

Lighting the Open Burners (Standard / Flame Failure Options)

- a. Select the burner required, depress and turn the corresponding gas control knob anti-clockwise to the 'HIGH' position.
- b. With the gas control knob depressed, manually light the burner.
- c. Release the gas control knob after approximately 10-20 seconds after lighting the burner.
- d. The burner should stay alight - if not, repeat Steps (a to (c above).
- e. To achieve simmer control, depress the gas control knob and rotate between the 'HIGH' and 'LOW' positions to achieve the temperature required.

Turning 'OFF' the Open Burners

- a. When the main burner is not required, depress and turn the gas control knob clockwise back to the 'OFF' position. The 'MAIN' burner will extinguish.

Griddle

CAUTION:

The griddle plate temperature reaches over 300°C in hottest points during normal operation at 'Full Flame' setting.

These griddles are fitted with Pilot and Flame Failure Protection as a standard option, which is incorporated by way of a thermo-electric system for each main burner. Flame Failure Protection will shut off the gas supply to that burner in the event that the pilot for that burner goes out, so that un-burnt gas is not expelled. **This is an important safety feature which is slowly becoming law throughout the world.**

! IMPORTANT

Always ensure that the grease tray is emptied regularly and never allow the grease tray to overflow.

Lighting the Griddle Burner

- a. Depress the gas control knob and rotate anti-clockwise to the 'PILOT' position.
- b. With the gas control knob depressed, press the piezo ignition button to ignite the pilot burner. Repeat Items 1 to 2 until the pilot is lit.
- c. Release the gas control knob approximately 10 to 20 seconds after lighting the pilot.
- d. The pilot should now remain alight - if not, repeat Steps (a. to (c. above).
- e. 'Full Flame' can now be achieved by depressing and rotating the gas control knob anti-clockwise to the first stop.
- f. Low flame can be achieved by depressing the gas control knob and rotating fully anti-clockwise to the 'Low Flame' position.
- g. To turn 'OFF' the griddle main burner, but keep the pilot burner alight, rotate the gas control knob to the 'PILOT' position. The griddle burner will extinguish and the pilot will remain alight.

Turning 'OFF' the Griddle Burner / Pilot

- a. To turn 'OFF' the 'PILOT', depress and turn gas control knob clockwise back to the 'OFF' position. The 'PILOT' burner will extinguish.

Oven

WARNING:

HEAT EXPOSURE DANGER EXISTS WHEN OPENING THE OVEN DOOR WHILE THE OVEN IS STILL HOT.

- Pilot Burner Ignition

This oven is fitted with a pilot as standard option and flame failure protection, which is incorporated by way of a thermo-electric system for the main burner. Flame failure protection will shut off the gas supply to the burner in the event that the pilot burner goes out, so that un-burnt gas is not expelled. **This is an important safety feature which is slowly becoming law throughout the world.**

! IMPORTANT

DO NOT USE aluminium foil or trays directly on the oven tray or flame baffle. NEVER block or cover the openings on each side of the flame baffle.

1. Depress and rotate the thermostat control knob anti-clockwise to the 'PILOT' position.
2. While holding the thermostat control knob depressed, press the piezo ignitor button to light the oven pilot burner. If required, repeat Items 1 to 2 until the oven pilot burner is lit.
3. View the oven pilot burner through the hole in the front lower sill, with the oven door open.
4. Release the thermostat control knob approximately 10-20 seconds after lighting the pilot burner.
5. The pilot burner should now remain alight - if not, repeat Steps 2 to 4 above.

- Main Burner / Thermostat

1. With the pilot burner alight, rotate the oven thermostat control knob to the desired oven temperature setting, this will regulate the gas supply to the oven burner and the oven main burner will light from the pilot burner.
2. To turn the main burner 'OFF', simply turn the thermostat control knob to the 'OFF' position.
3. The oven thermostat control knob is marked 100 to 310°C.
4. The thermostat can be set anywhere within this range and will thermostatically maintain oven temperature.

5. The following chart indicates approximate oven centre temperatures that will be maintained at the knob markings.

Gas Mark Temperature Conversions

NOTE:

Approximate guide information only.

GAS MARK

1	2	3	4	5	6	7
100	130	160	190	225	260	290

TEMPERATURE °C

6. Temperatures required between the above should be obtained by setting the control between the markings.

Turning the Oven to 'Standby' (Pilot 'ON' Only)

1. To turn 'OFF' the oven main burner / heating, set the oven thermostat control knob to the 'PILOT' position, this will turn the oven 'OFF', but leave the oven pilot burner 'ON'.
2. In this position the pilot burner will remain alight, but the main burner will not operate until the oven thermostat control knob is set to a temperature.

Oven 'Shut-Down'

To 'Shut Down' the oven, turn the oven thermostat control knob to the 'OFF' position. This will turn 'OFF'

IMPORTANT

Should any abnormal operation like;

- ignition problems,
- abnormal burner flame,
- burner control problems,
- partial or full loss of burner flame in normal operation,

be noticed, the appliance requires IMMEDIATE service by a qualified service person and shall not be used until such service is carried out.

the oven and extinguish the pilot burner. To relight the pilot burner, refer to 'Pilot Burner Ignition' in this section.

General

CAUTION:

Always turn 'Off' the gas supply at the mains supply before cleaning. This appliance is not water proof. Do not use water jet spray to clean interior or exterior of this appliance.

Clean the Range regularly. A clean Range looks better, will last longer and will perform better. Carbonised grease on the surface or between the trivets, griddle plates will hinder the transfer of heat from the cooking surface to the food. This will result in loss of cooking efficiency.

NOTE:

NEVER use a ribbed scraper blade on the flat surfaced griddle plate.

DO NOT use water on the trivets, burners and griddle plates while these items are still hot as warping and cracking may occur. Allow these items to cool down and then remove for cleaning. The entire trivets, griddle plates and burner caps can be dismantled for cleaning.

NOTE:

- **DO NOT use abrasive detergents, strong solvents or caustic detergents as they could corrode or damage the Range.**
- **In order to prevent the forming of rust on the trivets, griddle plate (if fitted) and burners, ensure that any detergent or cleaning material has been completely removed after each cleaning. The appliance should be switched 'On' briefly to ensure that the griddle plates become dry. Oil or grease should be spread over the griddle surface in order to form a thin protective greasy film.**

To keep your Range clean and operating at peak efficiency, follow the procedures shown:-

After Each Use

CAUTION:

Always ensure that if using a flat scraper tool on the griddle surface, an even pressure is applied over the whole surface of the scraper tool to prevent scoring of the surface.

NEVER bang the sharp edge of the scraper tool on the flat surface of the griddle as this will damage the griddle and invalidate the warranty.

1. Clean the Griddle and Range castings using a scraper tool to remove any build up of carbon.

2. Always ensure that scraper tool blades are changed regularly to ensure that the scraper tool works efficiently and prevents damage to the griddle plate surface.
3. Clean the range castings with a stiff nylon brush or a flexible spatula to remove any food debris.

Daily Cleaning

1. The grease / spill tray(s) should be checked and emptied frequently to prevent overflow and spillage. Remove the spill tray(s) while still warm so that the grease is in a liquid state. Empty any grease from the trays and wash the trays thoroughly in the same manner as any cooking utensil.
2. Clean the control panel with a damp cloth lightly moistened with a solution of mild detergent and water. Wipe dry with a clean dry cloth.
3. Remove the burner caps, bases, the trivets and thoroughly clean including the splash back, interior and exterior surfaces of the range with hot water, a detergent solution and a soft scrubbing brush.
4. Brush the griddle surface (optional - if fitted) with a soft bristled brush. Any carbon deposits should be removed using a scraper tool followed by wiping with a cloth to prevent accumulation of food deposits.
5. Dry the Range thoroughly with a dry cloth and polish with a soft dry cloth.

Weekly Cleaning

NOTE:

- **If the Range usage is very high, we recommend that the weekly cleaning procedure is carried out on a more frequent basis.**
- **Ensure that protective gloves are worn during the cleaning process.**
- **DO NOT use harsh abrasive or caustic detergents or strong solvents as they will damage the cooktop, burners and griddle plates (if fitted).**
- **DO NOT use water on the trivets, griddle plates and burners while they are still hot as cracking may occur. Allow these items castings to cool and remove for cleaning.**
- **DO NOT clean the burners in a dishwasher.**

Range Cooking Area

- a. Clean the Range cooking area using a soft cloth moistened with a mild detergent and hot water solution.
- b. Baked on deposits or discolouration may require a good quality stainless steel cleaner or stainless steel wool. Always apply cleaner when the appliance is cold and rub in the direction of the grain.
- c. It should not be necessary to remove the splash guards covering the burner manifolds for cleaning purposes. These can be cleaned in situ.
- d. Remove the grease / spill tray(s) and clean with a mild anti bacterial detergent and hot water solution using a soft bristled brush. Dry the grease spill tray(s) thoroughly with a dry cloth.

Griddle Plate

CAUTION:

Always ensure that if using a flat scraper tool on the griddle surface, an even pressure is applied over the whole surface of the scraper tool to prevent scoring of the surface.

NEVER bang the sharp edge of the scraper tool on the flat surface of the griddle as this will damage the griddle and invalidate the warranty.

NOTE:

In order to prevent the forming of rust on the griddle plate, ensure that all detergent and cleaning material has been entirely removed after each cleaning process. The appliance should be switched on briefly to ensure that the griddle plate becomes dry. Oil or grease should be spread over the griddle surface in order to form a thin protective greasy film.

- a. Remove and clean the grease / spill tray(s) frequently to prevent over spills.
- b. Clean the griddle surface thoroughly with a scraper tool or a wire brush. If necessary use a griddle stone or a scotch bright pad on the griddle surface to remove stubborn or accumulated carbon deposits.
- c. A scraper tool can be used for the removal of stubborn carbon and deposits.
- d. Occasionally bleach the griddle plate with vinegar when the plate is cold.
- e. Clean with hot water, a mild detergent solution and a scrubbing brush. Dry all components thoroughly with a dry cloth.
- f. The Range should be switched on briefly to ensure that the griddle plate becomes dry. A thin smear of cooking oil should be spread over the grates in order to form a protective film.

Trivets and Burners

- a. Remove the trivets from the top of the appliance, taking note that the trivets are manufactured with a lip on one edge, the lip must always be fitted to the outer edge (front and back) of the Range.
- b. Remove the burner cap and burner complete with venturi tube, from the top of the range manifold, taking care not to damage the thermocouple fitted to the mounting rail. (Fitted to Flame Failure Models Only).
- c. The trivets and burners should be cleaned with a mild detergent and hot water solution using a soft bristled brush. Dry thoroughly with a dry cloth.

Trivet Supports

- a. Remove all the trivet supports from the top of the range. Take note of the orientation of the trivet support when removing. The trivet support front side rail profiles are different from the rear side rail profiles.
- b. The trivet supports should be cleaned with a mild detergent and hot water solution using a soft bristled brush.
- c. Dry the trivet supports thoroughly with a dry cloth.

NOTE:

On units fitted with Flame Failure Thermocouples as standard or as an option, the Mounting Rail is Not removable for cleaning and no attempt should be made to remove this rail.

Stainless Steel Surfaces

- a. With the griddle plates and burners removed, clean the interior and exterior surfaces of the Range with hot water, a mild detergent solution and a soft scrubbing brush. Note that the gas control knobs are a push fit onto the gas control valve spindles and can be removed to allow cleaning of the front of the control panel.
- b. Baked on deposits or discolouration may require a good quality stainless steel cleaner or stainless steel wool. Always apply cleaner when the appliance is cold and rub in the direction of the grain.
- c. It should not be necessary to remove the splash guards covering the burner manifolds for cleaning purposes. These can be cleaned in situ.
- d. Dry all components thoroughly with a dry cloth and polish with a soft dry cloth.
- e. Remove the grease tray and clean with a mild anti bacterial detergent and hot water solution using a soft bristled brush.
- f. Dry the grease tray and all components thoroughly with a dry cloth and polish with a soft dry cloth.

Re-Fitting the Components to the Range

- a. Refit the trivet supports to the Range top, ensuring that the trivet supports are correctly fitted.

NOTE:

- **It is imperative that the trivet supports are correctly re-fitted to the appliance to ensure that the burners and trivets locate correctly and sit flush and level.**
- **Note the orientation of the trivet supports when re-fitting. The trivet support front side rail profiles are different from the rear side rail profiles and will only fit one way to the cooktop.**

- b. Refit the burners and burner caps onto the Range cooktop.
- c. Refit the trivets to the cook top, taking note that the trivets are manufactured with a lip on one edge, the lip must always be fitted to the outer edge (front and back) of the range.
- d. Refit the spill / grease tray(s) to the range.

Oven Interior

- a. Do not use wire brushes, steel wool or other abrasive materials to clean the oven interior.
- b. Clean the oven regularly with a good quality domestic oven cleaner.
- c. Once a week, remove and clean any built up of grease etc. from the oven racks and the bottom spill over cover.
- d. Dry the oven thoroughly with a dry cloth and polish with a soft dry cloth.

Periodic Maintenance

NOTE:

All maintenance operations should only be carried out by a qualified service person.

To achieve the best results cleaning must be regular and thorough and all controls and mechanical parts should be checked and adjusted periodically by a qualified service person. If any small faults occur, have them attended to promptly. Don't wait until they cause a complete breakdown. It is recommended that the appliance is serviced every 6 months.

Gas Control Valve Re-Greasing

The gas control valve should be dismantled and greased every 6 months to ensure the correct operation of the gas control valve.

To carry out this operation;-

- a. Remove gas control knobs from gas tap spindles by pulling knobs away from control panel.
- b. Remove the drip tray from the appliance.
- c. Remove two screws on underside of control panel, securing the control panel to the hob.
- d. Remove control panel from front of appliance.
- e. Remove 2 screws holding shaft plate to gas control body and remove control shaft and plate. Note the orientation of shaft for correct re-assembly.

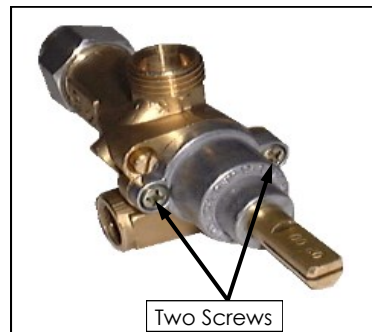

- f. Using needle nose pliers or similar, pull out the gas control spindle, again noting its orientation.

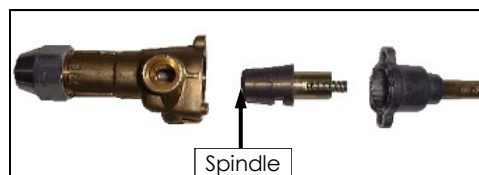

- g. Apply a suitable high temperature gas cock grease or lubricant such as ROCOL - A.S.P (Anti scuffing paste) / Dry Moly Paste to the outside of the spindle.
- h. Replace spindle and re-assemble the gas control valve in reverse order.
- i. Refit the control panel to the appliance and secure with the 2 screws.
- j. Refit the knobs to the gas control valve spindles.

Part 6 Fault Finding

This section provides an easy reference guide to the more common problems that may occur during operation of your equipment. This fault finding guide is intended to help you accurately diagnose and correct problems with your equipment.

Although this section covers the most common problems reported, you may encounter a problem not covered in this section. In such instances, please contact your local authorised service agent who will make every effort to help you identify and resolve the problem. Please note that the service agent will require the following information:-

- **Model Code and Serial Number of appliance. (Both can be found on the Rating Plate located on the appliance).**

Open Burners

Fault	Possible Cause	Remedy
Main burners will not light.	No gas supply.	Ensure gas is connected and turned on (bottles not empty).
	Wrong size or blocked injectors.	Call service provider.
	Obstruction in main burner.	Call service provider.
	Incorrect gas supply pressure.	Call service provider.
	Faulty gas control valve.	Call service provider.
Main burners go out when control knob released.	Releasing knob before thermocouple is heated. (Flame Failure Burners only).	Hold control knob in for longer (10 secs) after lighting the burner.
	Thermocouple incorrectly positioned.	Call service provider.
	Thermocouple faulty.	Call service provider.
	Gas valve magnet faulty.	Call service provider.
Low fire rate too high.	Incorrect supply pressure.	Call service provider.
	Low fire adjustment incorrect.	Call service provider.
Burner goes out when set to 'Low' position.	Incorrect supply pressure.	Call service provider.
	Low fire rate set too low.	Call service provider.
Main burner flame incorrect colour (yellow / wavy).	Incorrect gas pressure.	Call service provider.
	Incorrect injector size.	Call service provider.
	Obstruction in burner.	Call service provider.

Part 6 Fault Finding

Griddle Burners

Fault	Possible Cause	Remedy
Pilot won't light	Gas control knob not being held in for long enough.	Hold in button while lighting pilot.
	No gas supply.	Ensure gas is connected and turned on (bottles not empty).
	Gas pressure too low.	Call service provider.
	Blocked pilot injector.	Call service provider.
	Gas control valve faulty.	Call service provider.
Piezo ignitor not sparking.	Short in high tension lead.	Call service provider.
	Piezo electrode cracked / faulty.	Call service provider.
	Piezo Ignitor faulty.	Call service provider.
Pilot flame small / lazy / yellow.	Gas pressure too low.	Call service provider.
	Blocked / incorrect size pilot injector.	Call service provider.
Pilot goes out when knob released.	Releasing knob before the thermocouple is heated.	Hold gas control valve 'In' for longer (10s), see if pilot remains alight.
	Pilot flame too small.	Call service provider.
	Thermocouple faulty.	Call service provider.
	Gas valve magnet faulty.	Call service provider.
Main burners will not light.	Wrong size or blocked injectors.	Call service provider.
	Obstruction in main burner.	Call service provider.
	Incorrect supply pressure.	Call service provider.
	Faulty gas control.	Call service provider.
Main burner flame incorrect colour (yellow / wavy).	Aeration setting incorrect.	Call service provider.
	Incorrect gas supply pressure.	Call service provider.
	Incorrect main burner injector size.	Call service provider.
	Obstruction in burner.	Call service provider.
Pilot goes out when main burner comes on.	Incorrect gas pressure.	Call service provider.
	Faulty gas control valve.	Call service provider.

Part 6 Fault Finding

Oven

Fault	Possible Cause	Remedy
Piezo ignitor not sparking.	Short in high tension lead.	Call service provider.
	Piezo ignitor faulty.	Call service provider.
	Piezo electrode cracked or sooted up.	Call service provider.
Pilot won't light.	Knob on gas control valve won't go fully in.	Remove obstruction. Correct control / control panel mounting. Call service provider.
	No gas supply.	Call service provider.
	Gas pressure too low.	Call service provider.
	Blocked pilot injector.	Call service provider.
Pilot flame small.	Gas pressure too low.	Call service provider.
	Pilot injector restricted / incorrect size.	Call service provider.
Pilot goes out when knob released.	Releasing knob before thermocouple is heated.	Hold control in for longer (10 s), see if pilot will stay lit.
	Pilot flame too small.	Call service provider.
	Thermocouple faulty.	Call service provider.
	Faulty gas control.	Call service provider.
Pilot flame yellow / lazy.	Gas pressure incorrect.	Call service provider.
	Restriction in pilot injector or aeration.	Call service provider.
Pilot goes out when main burner comes on.	Incorrect gas pressure.	Call service provider.
	Faulty gas control.	Call service provider.
Pilot goes out while oven is in use, can re-light.	Gas supply - incorrect or fluctuating pressure.	Call service provider.
	Thermocouple faulty.	Call service provider.
	Draught at installation (blowing pilot out).	Move appliance to a draught free area or remove cause of draught.
Main burner will not light.	Wrong size or blocked main injector.	Call service provider.
	Small pilot flame.	Call service provider.
	Faulty gas control.	Call service provider.
	Incorrect supply pressure.	Call service provider.
Main burner does not burn correctly (Roars / lights back / incorrect colour).	Incorrect supply pressure.	Check supply pressure.
	Main burner aeration incorrect.	Call service provider.
	Incorrect size or blocked main injector.	Call service provider.
	Main burner faulty.	Call service provider.

Part 6 Fault Finding

Oven (Cont'd)

Fault	Possible Cause	Remedy
Set temperature not reached	Gas supply fluctuating.	Check supply for correct pressure.
	Gas valve not set up correctly.	Call service provider.
	Thermostat out of calibration.	Call service provider.
	Gas control faulty.	Call service provider.
Oven too hot	Gas valve not set up correctly.	Call service provider.
	Thermostat out of calibration.	Call service provider.
Door does not close	Tray in way of door.	Correctly position tray in rack.
	Door ball catch setting incorrect.	Call service provider.

Gas Conversion Procedure

CAUTION:

Ensure that the unit is isolated from the gas supply before commencing servicing.

NOTE:

- These conversions should only be carried out by qualified persons. All connections must be checked for gas leaks before re-commissioning the appliance.
- Adjustment of components that have adjustments / settings sealed (e.g. paint sealed) can only be adjusted in accordance with the following instructions and shall be re-sealed before re-commissioning this appliance.
- For all relevant gas specifications refer to the table at the end of this section.

Open Burners

1. Turn 'Off' the gas supply at the main supply.
2. Remove pot stands from top of the appliance, taking note that pot stands are manufactured with a lip on one edge, the lip must always be fitted to outer edge (front and back) of the cooktop.
 
3. Remove burner caps and burners (these are a loose fit to the cook top) from top of cooktop, (On Flame Failure units, take care not to damage the thermocouple which is fitted to the mounting bracket / rail. Fitted as standard for UK Market and optional for Non - UK Markets).



4. Unscrew and remove injectors (1/2" A/F) from the gas valves.
5. Determine correct injector sizes for the corresponding gas from the rating plate attached to the underside of the right hand side, front Cooktop lower trim.
6. Replace with the correct size injectors. Refer to the 'Gas Specifications' table at the rear of this section, for correct injector sizes.

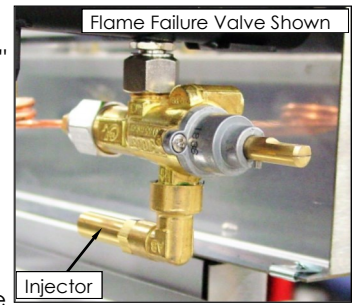

Low Fire Adjustment

- a. To adjust the open burner low fire adjustment, remove the gas control knobs from the front of the control panel.
- b. Adjust the low fire adjustment screw on the open burner gas control valves to obtain the desired flame size.

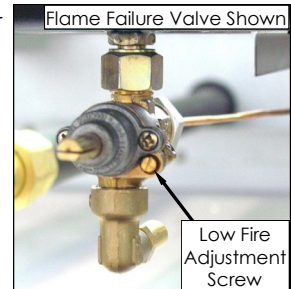

NOTE:

The 'Low Fire Screw' should be sealed with coloured paint on completion of the low fire adjustment.

Aeration Adjustment

- a. Check / adjust the main burner aeration gap. This gap should be set to the dimensions shown in the 'Gas Specifications' tables at the end of this section.

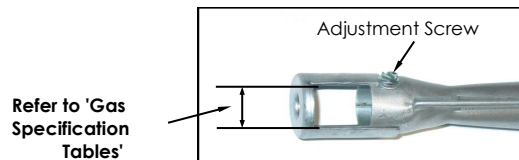

Thermocouple Location

- a. Check the thermocouple is correctly located and that the gap between the thermocouple and the main burner is as shown in the diagram opposite.
- b. Check that the thermocouple connection to the gas valve is tight.

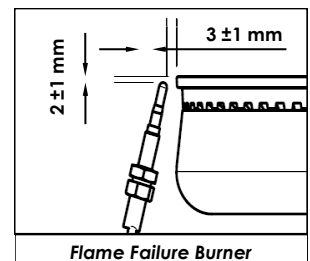

Griddle

Griddle Main Burner

- With the gas supply turned off at the main supply, remove the griddle plate section by lifting it straight off the Cooktop.
- Remove the gas control heat shield from around the griddle burner, this is just a push in fit.

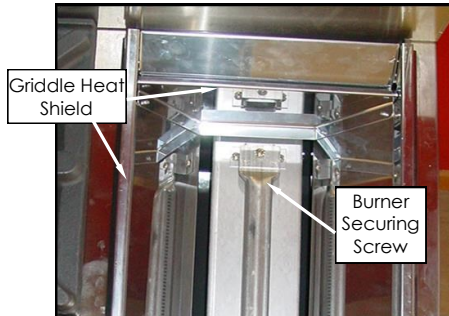

- Disconnect the piezo igniter from the mounting bracket. (For access purposes).

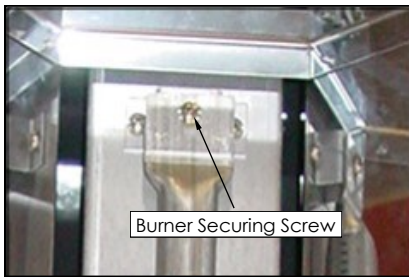

- Remove the main burner from the burner box. Undo the securing screw at the end of the burner, this will reveal the main burner injector.
- Remove and replace the main burner injector with correct size injector. Refer to the 'Gas Specifications' table at the end of this section, for correct injector sizes.

Griddle Burner Aeration Adjustment

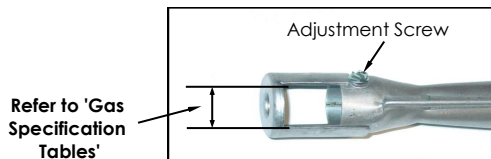

- Check / adjust the griddle main burner aeration gap. This gap should be set to the dimensions shown in the 'Gas Specifications' tables at the end of this section.
- Refit the burner to the griddle burner box.
- Refit gas control heat shield to griddle burner box.
- Refit griddle plate section to top of cooktop.
- Check the thermocouple connection to the gas valve is tight.
- Repeat Items a) to j) for all griddle main burners.
- Turn 'On' the gas supply at the mains, re-light the griddle burners and check the flame size on the 'LOW' flame position.

Griddle Pilot Burner

- Disconnect the pilot supply tube from the pilot burner.
- Remove the existing pilot injector and replace with the correct size for the gas being used. Refer to the 'Gas Specifications' table at the end of this section, for correct injector sizes.



- Re-connect pilot supply tube to pilot burner.
- Refit the piezo igniter to the mounting bracket.
- Repeat Items a) to d) for all pilot burners.

Low Fire Adjustment

- To adjust the griddle burner 'LOW' fire adjustment, remove the griddle gas control knobs from the front of the control panel.
- Adjust the low fire adjustment screw on the griddle gas control valve only, to obtain the desired flame size.



NOTE:

The 'Low Fire Adjustment Screw' should be sealed with coloured paint on completion of the low fire adjustment.

Thermocouple Connection

- Check that the thermocouple connection to the gas valve is tight.

NOTE:

When screwing the thermocouple back into the gas control valve, once threaded up, tighten up another 1/4 turn only. Do not over tighten.

Part 7 Gas Conversion

Oven

Main Burner

1. Turn off gas supply at main supply.
2. Remove oven racks, oven tray and flame baffle from inside oven.
3. Remove the oven main burner.

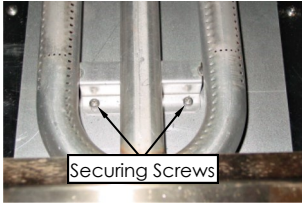

Main Burner - CR9 Model

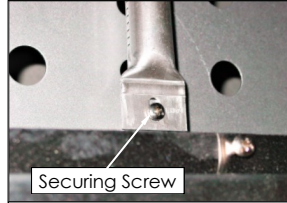

Main Burner - CR6 Model

4. Remove main burner injector and replace with correct size injector. (Refer to 'Gas Specifications' table at rear of this section).

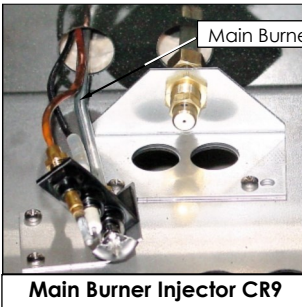

Main Burner Injector CR9

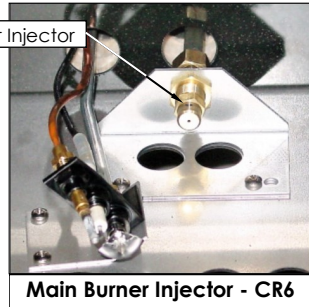

Main Burner Injector - CR6

5. Refit the Main burner.

Pilot Burners

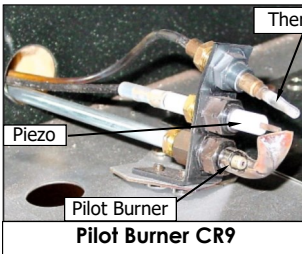

Pilot Burner CR9

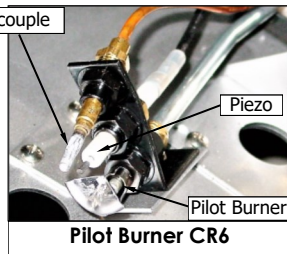

Pilot Burner CR6

1. Remove the following:-
 - Thermocouple (for access).
 - Piezo electrode (for access).
 - Unscrew pilot supply tube.
2. Remove pilot injector and replace with correct size injector. (Refer to 'Gas Specifications' table at rear of this section).
3. Refit the following:-
 - Thermocouple (removed for access).
 - Piezo electrode (removed for access).
 - Pilot supply tube.
 - Flame baffle.
 - Oven racks.
 - Oven trays.

Low Fire Adjustment

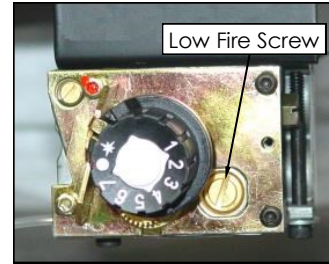

1. To change the thermostat 'Low Fire' screw for the gas type required, remove the following:-
 - Gas control knobs.
 - Control Panel.
 - Unscrew 'Low Fire' screw from gasvalve.
 - and fully screw in the new 'Low Fire' screw for the new gas type. (Refer to the 'Gas Specifications' table at the rear of this section for the correct low fire screw sizes).
2. Refit the control panel.
3. Refit the gas control knobs.

Gas Regulator

- NAT Gas / LPG Only.

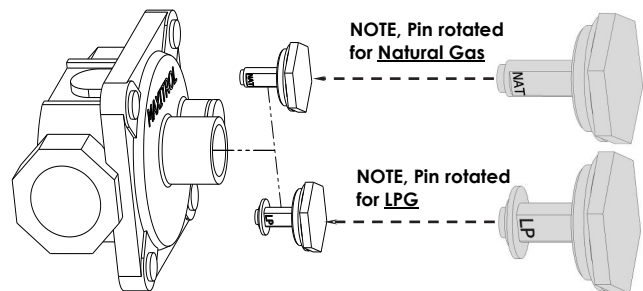

NOTE:

The regulator supplied is convertible between Natural Gas and LP Gas, but its outlet pressure is fixed ex-factory and is NOT to be adjusted.

1. Ensure that the gas supply is turned 'Off' at the mains.
2. Unscrew the hexagonal cap (23mm A/F) from the regulator.
3. Un-clip the plastic pin from the cap, reverse the pin and re-fit it back to the cap the correct way for the gas type to be used. **(Either 'LP' or 'NAT' should be visible on the flank of the pin once re-fitted to the cap).**
4. Screw the cap back into the regulator hand tight only.

Gas Type Identification Label

On completion of gas conversion, replace gas type identification label located at:-

- Rear of appliance, above gas connection.
- Beside the rating plate.

Commissioning

Before leaving the converted installation;

1. Check all gas connections for leakages using soapy water or other gas detecting equipment.

WARNING:

DO NOT USE A NAKED FLAME TO CHECK FOR GAS LEAKAGES.

2. Check the following functions in accordance with operating instructions specified in the 'Operation' section of this manual.
 - Light Cooktop Open Burners. (Standard / Flame Failure Option).
 - Check Cooktop Low Fire Burner operation.
 - Check Cooktop High Fire Burner operation.
 - Lighting the Griddle Burner operation (If fitted).
 - Check Griddle Burner operation (If fitted).
 - Light Oven Main Burner.
 - Check Oven Low Fire Burner operation.
 - Check Oven High Fire Burner operation.
 - Ensure that all controls operate correctly.
 - Ensure that operating pressure remains correct.
3. Ensure any adjustments done to components that have adjustments / settings sealed (e.g. paint sealed), these are re-sealed.

NOTE:



If it is not possible to get the appliance to operate correctly, shut 'Off' the gas supply and contact the supplier of this appliance.

Part 7 Gas Conversion

Gas Specifications

- United Kingdom

Category: **II₂H3P. (20, 37)**
 Flue Type: **A₁**

		Natural Gas (G20)	Propane (G31)	
Open Burner	Burner Injector	Ø 1.90mm	Ø 1.20mm	
	Low Fire Setting	¾ turn open c.c.w.	¼ turn open c.c.w.	
	Burner Aeration Setting	16mm open	16mm open	
Griddle	Burner Injector	Ø 2.00mm	Ø 1.25mm	
	Low Fire Setting	5/8 turn open c.c.w.	3/8 turn open c.c.w.	
	Burner Aeration Setting	Fully open	Fully open	
	Pilot Injector	0.35	0.23	
Oven	CR6 Model	Burner Injector	Ø 2.40mm	Ø 1.40mm
		Low Fire Screw	Ø 1.00mm	Ø 0.60mm
		Burner Aeration Setting	Fully open	10mm open
		Pilot Injector	0.35	0.23
	CR9 Model	Burner Injector	Ø 2.50mm	Ø 1.50mm
		Low Fire Screw	Ø 1.50mm	Ø 0.90mm
		Burner Aeration Setting	Fully open	Fully open
		Pilot Injector	0.35	0.23
Supply Pressure		20 mbar	37 mbar	
Burner Operating Pressure (*)		10 mbar	28 mbar	
Gas Regulator Cap Screw				

NOTE:

- (*) Measure burner operating pressure at manifold test point with two burners operating at 'High Flame' setting.
- NAT, & LPG - Operating pressure is ex-factory set and is not to be adjusted, apart from when converting between gases, if required.
- Refer to the information in this section for further details.

Part 8 Replacement Parts List

Replacement Parts List

IMPORTANT:

Only genuine qualified replacement parts should be used for the servicing and repair of this appliance. The instructions supplied with the parts should be followed when replacing components.

For further information and servicing instructions, contact your nearest qualified service branch (contact details are as shown on the reverse of the front cover of this manual).

When ordering spare parts, please quote the part number and the description as listed below. If the part required is not listed below, request the part by description and quote model number and serial number which is shown on the rating plate.

Open Burners

230014	Pot Stand.		
230088	Pot Stand Support.		
230631	Front Burner Assy.		
230632	Rear Burner Assy.		
230288	Burner Cap.		
230637	Gasket Burner Assy.		
031190	Injector	(Nat. Gas)	Ø 1.90mm.
031120	Injector	(LP Propane)	Ø 1.20mm.
018680	Gas Valve c/w 1/8" Elbow		(Standard Burners Only).
231560	Gas Valve FF c/w 1/8" Elbow		(Flame Failure '-F' Models Only).
230671	Thermocouple - (500mm).		(Flame Failure '-F' Models Only).
242361	Knob - Assy	(Std / F).	

Griddle

014105	Griddle Burner.		
230213	Griddle Reflector Assy.		
227403	Gas Control Valve.		
242362	Knob - Assy.		
032200	Injector	(Nat. Gas)	Ø 2.00mm.
032125	Injector	(LP Gas)	Ø 1.25mm.
019215K	Pilot Burner (Fully Assembled).		
026488	Pilot Injector	(Nat. Gas)	0.35.
019217	Pilot Injector	(LP Gas)	0.23.
019428	Thermocouple - (320mm).		
227508	Piezo Ignitor.		
228047	Piezo H.T. Lead.		
230289	Grease Tray	(1 per 300mm Griddle Section).	
242330	Griddle Plate	300mm.	
242329	Griddle Plate	600mm.	
242328	Griddle Plate	900mm.	

Part 8 Replacement Parts List

Oven

022446	Oven Burner (CR6).
230441	Oven Burner (CR9).
228703	Eurosit Gas Control Kit.
018682	Thermocouple (1500mm Long).
230586	Piezo Igniter.
232691	HT Lead 1600mm.
230556	Oven Rack.
230462	Oven Tray.
011005	Ball Catch Assy.
230487	Top Striker Plate.
010254	Bottom Striker Plate.
227469	Door Handle.

CR6 Model

032240	Injector	(Nat. Gas)	Ø 2.40mm.
032140	Injector	(LP Gas [Propane])	Ø 1.40mm.
022409	Low Fire Screw	(Nat. Gas)	Ø 1.00mm.
234038	Low Fire Screw	(LP Gas)	Ø 0.60mm.

CR9 Model

032250	Injector	(Nat. Gas)	Ø 2.50mm.
032150	Injector	(LP Gas)	Ø 1.50mm.
022408	Low Fire Screw	(Nat. Gas)	Ø 1.50mm.
022407	Low Fire Screw	(LP Gas)	Ø 0.90mm.

CR6 / CR9 Models

026488	Pilot Injector	(Nat. Gas)	0.35.
019217	Pilot Injector	(LP Gas)	0.23.

General

230138	Drip Tray (CR6).
230139	Drip Tray (CR9).
229674	Rear Roller Assy.
234059	Leg Assy (150mm).
242364	Knob 8mm Gas 100 - 310°C.

Gas Regulator

228531	Regulator 3/4" BSP F/F Convertible(Nat. Gas / LP Gas)
--------	---

Gas Conversion Kits

Part No.	Description
242717	Gas Conversion Kit - 600 Gas Cooktop - 'Natural Gas'
242718	Gas Conversion Kit - 600 Gas Cooktop - 'LPG (Propane) Gas'
242715	Gas Conversion Kit - 900 Gas Cooktop - 'Natural Gas'
242716	Gas Conversion Kit - 900 Gas Cooktop - 'LPG (Propane) Gas'
242713	Gas Conversion Kit - 600 Gas Ranges - 'Natural Gas'
242714	Gas Conversion Kit - 600 Gas Ranges - 'LPG (Propane) Gas'
242711	Gas Conversion Kit - 900 Gas Ranges - 'Natural Gas'
242712	Gas Conversion Kit - 900 Gas Ranges - 'LPG (Propane) Gas'

