

# Installation and operation manual

---

Under counter machines

**CLASSEQ**

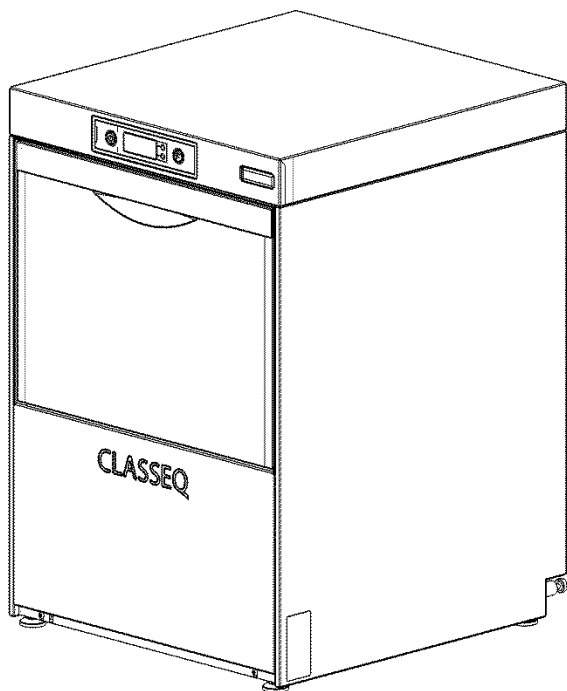

**CAUTION:** Read these instructions before operating the machine

## Accessories and Extras

### Detergents and Hygiene Products

Application	Product Name	Quantity	Order Code
Glass washing Products	Super clean glass washing detergent	2x5L	20003020
	G3 glass rejuvenator	10kg	20003018
	Super shine glass washing rinse aid	2x5L	20003026
	Glasswasher starter pack glasswasher detergent	2x5L	20003306
	Glasswasher starter pack rinse aid	2x5L	
Dishwashing Products	Super clean dishwashing detergent	2x5L	20003007
	Super clean dishwashing detergent	20L	20003040
	Super shine dishwashing rinse aid	2x5L	20003013
	Super shine dishwashing rinse aid	20L	20003011
	Dishwashing starter pack detergent	2x5L	20003306
	Dishwashing starter pack rinse aid	2x5L	
	Super descaler	2x5L	20003006
Salt	Table Salt DuoMatik	25kg	20005167
	Granulated	25kg	20005166

### Stands



Product Name	Order Code
400mm Stainless steel 475(w) x 497(d) x 410(h)	30007363
500mm Stainless steel 575(w) x 580(d) x 400(h)	30007365
350mm Steel coated stand 403(w) x 462(d) x 415(h)	30007235
400mm Steel coated stand 435(w) x 490(d) x 415(h)	30007236
500mm Steel coated stand 543(w) x 565(d) x 440(h)	30007237

### Baskets

Product Name	Order Code
400mm <sup>2</sup> open basket	30001165
500mm <sup>2</sup> open basket	30001197
400mm <sup>2</sup> plate basket	30001166
500mm <sup>2</sup> plate basket	30001198



## Basket Inserts

Product Name	Order Code
Single cutlery holder	30001167
400mm plate rack	30007213
8 Compartment cutlery holder	30001199



## Water treatment



Description	Order code	
Under counter range	8 litre	20004396
	12 litre	20004397
	16 litre	20004398
	20 litre	20004399
	Automatic (Cold water)	20003213
	Automatic (Hot water)	20003217

## Accessories

Description	Order Code	
Boostermatic	Pressure Pump (where water pressure is below 45psi/3bar)	30007219
Fixing Bracket	For pump	30009322
Mixer Valve	For hot water installations	30007229

## Service and Maintenance Contracts

Enjoy complete peace of mind with **Classeq's** range of tailored service contracts. We will be happy to discuss your requirements and provide a proposal which will cater for all your ware washing service needs.

Four Star ★★★★	Break down cover only. Call out and labour included. All replacement parts will be charged.
Five Star ★★★★★	Break down cover with call out, labour and parts included

Dear Customer,

Thank you for choosing **Classeq**, the machine you have selected has been designed to give you lasting service.

Please read these instructions before installing, commissioning and operating this machine.

The information contained herein is provided to avoid accidental risks and/or damage to either yourself or your machine.

Make sure you and any other users understand the controls prior to using your machine.

Please keep these instructions in a safe place for future reference.





If you have any questions, or are not sure about any information contained in this manual please contact either your distributor or **Classeq**, in the 'Useful contact details' section of this manual (►17).

## TABLE OF CONTENTS

1.	EXPLANATION OF SYMBOLS USED.....	4
2.	WARNING AND SAFETY INFORMATION .....	5
3.	KNOW YOUR MACHINE.....	7
4.	PRE-INSTALLATION .....	10
5.	INSTALLATION .....	12
6.	COMMISSIONING .....	14
7.	OPERATION .....	17
8.	SERVICE AND MAINTENANCE .....	20
9.	TROUBLESHOOTING.....	22
10.	DECOMMISSIONING .....	24
11.	APPENDIX A – WATER SOFTENER SETTINGS .....	25
12.	APPENDIX B – WATER HARDNESS EXPLAINED .....	26
13.	APPENDIX C – WATER HARDNESS MAP.....	27
14.	APPENDIX D – MACHINE SPECIFICATIONS .....	28
15.	PARTS AND LABOUR WARRANTY .....	30
16.	NOTES .....	31
17.	USEFUL CONTACT DETAILS.....	34

# 1. Explanation of symbols used

The following symbols have been used in this manual

 <b>DANGER!</b>	Warning against potential serious or fatal injuries to persons if the described precautionary measures are not taken.	▶	This symbol refers to a chapter with more detailed information
 <b>Warning!</b>	Warning against potential minor injuries to persons or potential material damage if the described precautionary measures are not taken	1	Refer to foot note at bottom of page
 <b>Caution</b>	Warning against defects in or destruction of the product if the described precautionary measures are not taken.		Recycle

## 2. Warning and safety information

### 2.1 Danger warnings

For safety reasons your machine **MUST** be bonded to adjacent metalwork or earthed so that it is at the same potential (i.e. voltage) (▶4.1).

A means for disconnection that has a pole separation of more than 3mm must be incorporated in the fixed wiring in accordance with wiring rules (▶4.2).

All mains electrical work must be carried out in accordance with local and national regulations, and by a qualified electrician (▶5.3.1).

The machine **MUST** be disconnected from its power source during cleaning, servicing or replacing parts (▶8).

Ensure the base of the machine is never submerged or standing in water when operating the machine (▶8).

### 2.2 Warnings

The machine should only be operated at or within the voltage specified on the rating plate (▶3.1).

Old existing, defective or damaged water supply hoses are NOT to be used when installing your machine (▶4.3.1).

The installer and user are responsible for ensuring the installation and operation of this machine are in accordance with this manual and local and national regulations (▶4.3.3).

**DO NOT** use electrical extension lead(s) to supply power to your machine (▶5.3.1).

**DO NOT** run the machine if there is no salt in the salt reservoir, as this will allow lime scale to build up, also any lime scale will invalidate your warranty (▶6.5) (▶8.4.1).

**DO NOT** add any chemicals, such as detergent or rinse aid to the reservoir. These will cause damage to the machine (▶6.5) (▶8.4.1).

Children should be supervised to ensure that they do not play with, or operate the machine (▶7).

Be aware: Wares may be hot when removed from machine (▶7.8).

Before cleaning the wash chamber, ensure all sharp items, such as broken glass or other items which could cause injury are removed carefully (▶8.1).

**DO NOT** use cleaning agents that contain CHLORINE, BLEACH or HYPOCHLORITE (▶8.1).

Wear protective clothing, protective gloves and protective goggles when handling chemicals and observe all safety notes and dosing recommendations printed on their packaging (▶5.6) (▶8.5).

If the machine is being drained immediately after use, water draining from the 'Boiler drainage hose' may reach over **95°C** (▶10).

### 2.3 Cautions

Only use commercial grade detergents and rinse-aids within your machine (▶5.6).

**Only use granulated salt** (*max. grain size 5 – 7 mm*). Salt tablets are not suitable (▶6.5) (▶8.4.1).

If the reservoir cap is not properly secured, water and/or chemicals can leak in or out of the unit causing damage to the machine (▶6.5) (▶8.4.1).

Always remove excess food/debris from any dishes/glasses to be washed. **DO NOT** use your machine as a waste disposal unit (▶7.8).

It is very important the machine is drained down at the end of each working day (▶7.9).

**DO NOT** use STEEL WOOL, WIRE BRUSHES or any other abrasive materials (▶8.1).

Damage to the machine caused by lime scale, or poor water quality will **NOT** be covered by the **Manufacturer's Warranty** (▶8.3).

De-scale must not remain in the machine for more than 2 hours (▶8.5).

Ensure that the items placed on the open door of the machine do not exceed 20kg in weight (▶8).

### 3. Know your machine

Before installing your machine you should familiarise yourself with the various components shown below. For detailed specification see Appendix D (►14)

#### 3.1 Machine layout

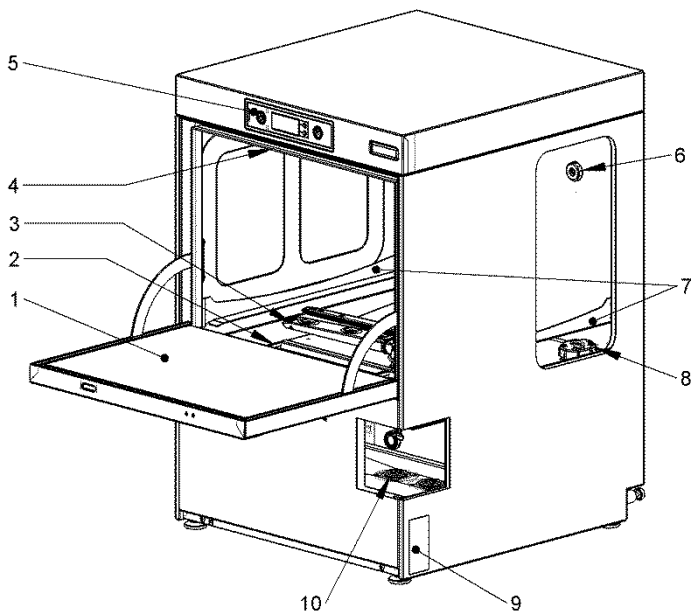

Item	Description
1	Door <sup>1</sup>
2	Primary filters
3	Bottom wash and rinse arms
4	Top wash and rinse arms <sup>2</sup>
5	User interface
6	Anti-syphon device <sup>3</sup>
7	Basket ramp
8	Salt reservoir cap <sup>4</sup>
9	Rating plate
10	Secondary filters
11	Drain plug <sup>5</sup>

<sup>1</sup> The door of the machine should **NEVER** be used as a step or seat.

<sup>2</sup> Only fitted to 500mm machines and 400mm machines with integral water softener.

<sup>3</sup> Pumped drain machines only.

<sup>4</sup> Only in machines with water softener fitted.

<sup>5</sup> Gravity drain machines only.



### 3.2 User interface

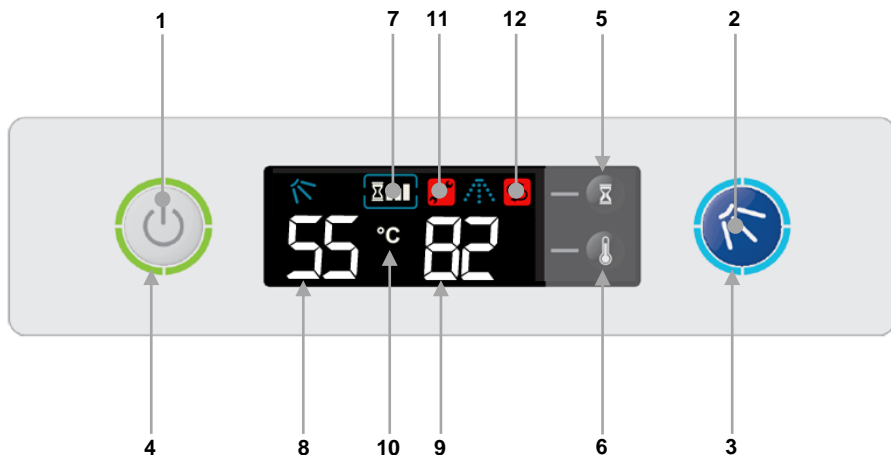







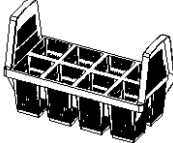

Item	Description
1	On/Off button
2	Cycle button
3	Cycle indicator
4	Heating indicator
5	Program select
6	Temperature unit button
7	Program indication
8	Wash temperature
9	Rinse temperature
10	Temperature unit display
11	Error indicator
12	Refill salt indicator <sup>6</sup>

<sup>6</sup> Only on machines with a water softener fitted

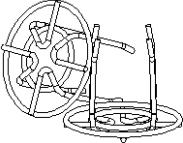
### 3.3 Accessories with your machine

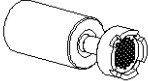
Items included within machine<sup>7</sup>

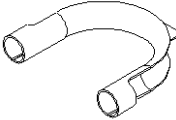
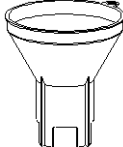
<p>Installation and operation manual</p>	<p>Good practice guide</p>
 <p><b>Open basket</b> x2 Glass washer x1 Dishwasher</p>	 <p><b>Plate basket</b> x1 Dishwasher only</p>
 <p><b>Cutlery basket</b> x1 Dishwasher only</p>	 <p><b>Primary filters</b> x1 Left hand filter x1 Right hand filter<sup>8</sup></p>
 <p><b>Secondary filters<sup>9</sup></b> x2</p>	 <p><b>Drain plug<sup>10</sup></b> x1</p>
 <p><b>Bottle weights</b> x2</p>	 <p><b>Water inlet hose</b> x1</p>
 <p><b>Waste hose hook</b> x1</p>	 <p><b>Water softener funnel<sup>11</sup></b> x1</p>
<p><b>2kg Bag of salt<sup>11</sup></b> x1</p>	

<sup>7</sup> Images are for reference only, actual parts may differ

<sup>8</sup> Differs depending on drain type

<sup>9</sup> Only 1 on gravity drain machines

<sup>10</sup> Only on gravity drain machines

<sup>11</sup> Only on machines with a water softener fitted

## 4. Pre-installation

After unpacking your machine, check it for any possible transport damage. Never install and use a damaged machine. If your machine is damaged contact your retailer immediately.

Make sure the water and electricity connections of your machine are in compliance with these instructions.

Remove all outer packaging and the protective film from your machine before positioning it.

Ensure all packaging materials are disposed of in accordance with local and national regulations.

### 4.1 Equipotential bonding



**DANGER!**

For safety reasons your machine **MUST** be bonded to adjacent metalwork or earthed so that it is at the same potential (*i.e.* voltage).

Consult your distributor, **Classeq** or a qualified electrician if you are unsure how to do this.

### 4.2 Electrical connection

Prior to connecting the machine, ensure that the voltage and the supply fuse comply with the rating of the machine.

A means for disconnection that has an all pole separation of more than 3mm must be incorporated in the fixed wiring in accordance with wiring rules.

#### 4.2.1 Electrical cable specification

If the mains electrical supply cable is damaged or has deteriorated, it **MUST** be replaced by a cable or cord assembly supplied by **Classeq**, its service agents or similarly qualified persons in order to avoid hazards, and be to the following minimum specifications.

Machine rating (Volts / Phase / Amps)		Cable type
220-240V / 1N~/13A		H07RN-f 3G 1.5
220-240V / 1N~/28A		H07RN-f 3G 4.0
380-415V / 3N~/11A		H07RN-f 5G 2.5
Temp. rating	Length of cable	Conforms to
80°C min.	3m	IEC 60335-2-58 & IEC 60227 types 56 & 57

For electrical rating of your machine refer to the rating plate (►3.1).

### 4.2.2 Electrical connection specification

Depending on the specification of your machine it may be supplied with or without a moulded mains electrical plug.

### 4.3 Water connections

Commercial machine wash results may be affected by external conditions such as incoming water temperature, pressure, hardness and choice of chemicals.

#### 4.3.1 Water supply hose

**Classeq** recommend installing a shut off valve in the mains water supply line near the machine such that it is easily accessible (►14.2).

Your machine is supplied with a new WRAS approved water hose (►3.3), requiring a G $\frac{3}{4}$ " ( $\frac{3}{4}$ " BSP) male threaded connection at the mains water outlet.



**Warning**

Old existing, defective or damaged water supply hoses are **NOT** to be used when installing your machine.

### 4.3.2 Water supply restrictions

#### Incoming water temperature:

- 4°C minimum
- 55°C maximum

#### Supply water dynamic pressure:

- 0 to 2 bar (0 to 200 kPa)

(External rinse booster pump required)

- 2 to 4 bar (200 to 400 kPa)

(No modifications required)

- >4 bar (400 kPa)

(Pressure reducing valve required)

#### Minimum supply flow rate:

- Without water softener:  
11 litre/minute
- With water softener:  
4 litre/minute

#### Water hardness:

For the longevity of your machine, and to ensure you get consistently good results, it is essential your machine either has an internal water softener unit, is fed from a soft water supply ( $\leq 3^{\circ}\text{dH}$ ) or is connected to an appropriate water softener. Appendix C has a map that can be used as a guide to water hardness in the UK (►13).

**IMPORTANT - All supplier warranties are void if lime scale is present within your machine.**

### 4.3.3 Waste water connection

The waste system of your machine will vary depending on the variant. You can identify the type of drain your machine has by checking whether there is a drain plug present (►3.1). Machines with a drain plug are gravity drain and without are pumped drain.

- **Gravity drain machines:**

If your machine has a drain plug fitted in the wash sump the waste hose will fit into  $\text{Ø}40\text{mm}$  plumbing **or** over a  $\text{Ø}20\text{mm}$  spigot.

The hose for this machine has to lead away below the base of the machine.

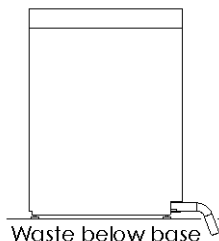

- **Pumped drain machines:**

The waste hose of your machine will fit into  $\text{Ø}40\text{mm}$  plumbing **or** over a  $\text{Ø}28\text{mm}$  spigot.

The waste plumbing for the machine can be up to a maximum of the following heights from the base of the machine:

Machine size	Max waste height (mm)
350mm	420
400mm	540
500mm	600

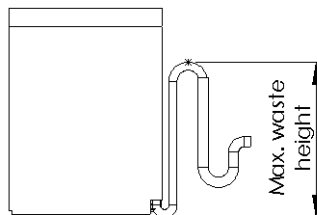

## 5. Installation



### Warning

The installer and user are responsible for ensuring the installation and operation of this machine are in accordance with this manual and with local and national regulations.

### 5.1 Recommended hand tools

**Classeq** recommends that the following hand tools are used to assist in installing your machine:

- Spirit level
- 8mm spanner
- Multimeter or voltmeter
- Insulated No. 2 Posi screw driver
- Drill with 8mm bit

### 5.2 Machine placement

Your machine should be installed on the stable surface that is capable of holding the full weight of the machine (►14) and withstand the vibration of regular use.

Ensure there is a minimum of 10mm clearance each side of the machine and with 20 mm clearance at the top and rear of the machine. (►14).

Once installed use the adjustable feet to ensure your machine is stable, with its weight being distributed equally and does not tilt more than 2° in any direction.

Your machine should be placed in a location that allows the required supplies to be fitted (►14).

When positioning the machine, ensure that the water inlet, chemical tubes and drain hoses are not kinked or squashed. Care must also be taken to ensure your machine does not rest upon any of its supply hoses/leads.

## 5.3 Electrical connection

### 5.3.1 Mains cable connection

Your machine must be connected directly to the mains electricity using the mains electrical cable provided. **DO NOT** use electrical extension lead(s) to supply power to your machine.

Prior to connecting your machine, ensure the electrical supply has a suitable and adequate circuit breaker/fuse. For the electrical rating of your machine refer to the rating plate (►3.1). Contact your distributor, qualified electrician or **Classeq** if you are unsure how to check this.



### DANGER!

All mains electrical work must be carried out in accordance with local and national regulations, and by a qualified electrician

When hard wiring the machine into the socket use the multimeter or voltmeter to ensure that the connection point does not have any voltage before attempting to connect the terminals.



### 5.3.2 Equipotential bonding

Your machine **MUST** be earth bonded to adjacent metalwork or earthed so that it is at the same potential (*i.e. voltage*).

The equipotential bonding stud is located at the rear of the machine (►14) and has a M5 nut fitted. Use the spanner to connect the earth wire to this location and ensure the nut is securely fastened.

### 5.4 Water supply hose connection

Connect the 90° bend end of the water supply hose to your machine (►14) and the straight end to your water mains supply.

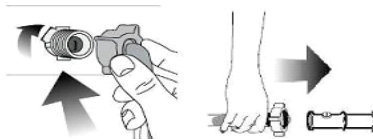

Ensure the rubber seals within the ends of the hose are in place.

Ensure all connections are water tight before using your machine.

### 5.5 Waste water connection

Fit the waste hose of your machine to the site plumbing without kinking it.

Ensure that your hose is fitted to the plumbing in a way that it will not come off or out during the operation of the machine.

The waste plumbing must only be connected into the foul drains and not the surface water drainage system.

A form of back flow prevention must be installed into the waste plumbing in accordance with local and national regulations.

Ensure that the waste hose of the machine does not pass the height of the sticker on the rear of the machine when the machine is in place.

Where the machine is fitted to a stand pipe the waste hose hook (▶3.3) should be used to help manage the hose

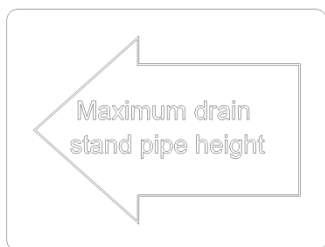

and should be routed to the chemical bottle locations, excess tube may be removed. The tubes need to be long enough to allow the bottles to be moved without the risk of falling over.

Blue tube	Rinse aid
Clear tube	Detergent

Remove the cap from each of the chemical bottles and use the drill to make a hole in middle.

Feed the tube through the hole and fit the bottle weights and filters supplied the end of each tube before dropping them into the chemical bottles and fastening the caps.

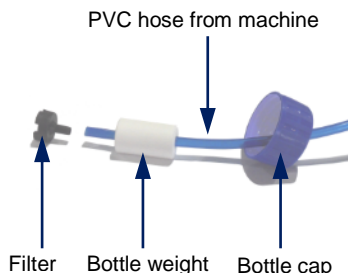

### 5.6 Fitting chemical bottles



**Warning**

Wear protective clothing, protective gloves and protective goggles when handling chemicals and observe all safety notes and dosing recommendations printed on their packaging



**Caution**

Only use commercial grade detergents and rinse-aids within your machine.

The chemical bottles should be placed in a safe, stable location that is close to the machine (▶14.2) and easily accessed to check chemical levels and replace the bottles as needed.

A coil of PVC tube is connected to each of the chemical pumps inside the machine. These tubes exit the rear of the machine

## 6. Commissioning

### 6.1 Commissioning interface

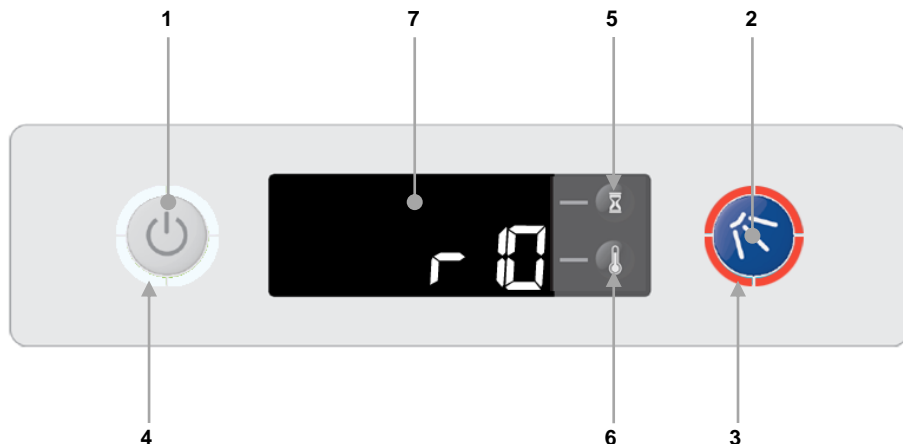

Item	Description
1	Exit button
2	Enter button
3	Cycle indicator
4	Heating indicator
5	Up button
6	Down button
7	Display

### 6.2 Commissioning mode

With the machine turned on at the mains electrical supply but off at the display, press and hold the Exit (1) and Enter (2) buttons for 3sec. the display (7) will show the first menu item and the cycle indicator (3) will illuminate red.

If no buttons have been pressed for a period of time the machine will cancel this mode and return to the off state.

Below is the complete menu list:

Display	Description
r**	Rinse aid setting (e.g. 15 = 1.5mL/L)
rP□	Rinse aid prime
d**	Detergent setting (e.g. 33 = 3.3mL/L)
dP□	Detergent prime
h**	Water softener setting (if fitted)

\*\* Refers to the setting of the chemical dosing and water hardness. For example the default setting for rinse aid is 1ml of chemical per litre of water this will be displayed as '1 0' the default setting for detergent is 3ml of chemical per litre of water this will be displayed as '3 0'

### 6.3 Setting chemical dosage

Your machine will be set to a default chemical dosing setting however since there are many different chemicals on the market and these each have different concentration requirements the dosage can be adjusted by following the instructions below.

1. Refer to your chemical bottle or contact the supplier to find the concentration requirements for your rinse aid and detergent in millilitres of chemical per litre of water (ml/L).
2. Enter commissioning mode (▶6.2).
3. Using the up and down keys (**5 & 6**), scroll to the rinse aid setting menu item (r\*\*) and press enter (**2**).
4. The display will flash.
5. Use the up and down keys (**5 & 6**) to scroll to the required setting and press enter (**2**).
6. Using the up and down keys (**5 & 6**), scroll to the detergent setting menu item (d\*\*) and press enter (**D**).
7. The display will flash.
8. Use the up and down keys (**5 & 6**) to scroll to the required setting and press enter (**2**).
9. Press exit (**1**) until you are out of commissioning mode.

### 6.4 Priming chemicals

Before the machine can be used the chemical tubes will need to be filled with chemicals, in order to do this you will need to follow the below instructions to prime the chemical pumps.

1. Enter commissioning mode (▶6.2).
2. Using the up and down keys (**5 & 6**), scroll to the rinse aid prime menu item (rP) and press enter (**2**).
3. The display will flash and will change to rP l.
4. This will continually run the rinse aid pump for a maximum of 12 minutes and draw chemicals into the machine. When the chemicals have reached the back of the machine press enter (**2**).

again to stop the pump.

5. The display will stop flashing and return to rP l.
6. Using the up and down keys (**5 & 6**), scroll to the detergent prime menu item (dP) and press enter (**2**).
7. The display will flash and will change to dP l.
8. This will continually run the detergent pump for a maximum of 2 minutes and draw chemicals into the machine. When the chemicals have reached the back of the machine press enter (**2**) again to stop the pump.
9. The display will stop flashing and return to dP l.
10. Press exit (**1**) until you are out of commissioning mode.



## 6.5 Integral water softener (if fitted)

### 6.5.1 Commissioning the water softener unit

To commission the water softener unit follow the instructions below:

1. Open the door to the machine.
2. Remove the right hand basket ramp.
3. Open the salt reservoir cap at the back right hand corner of the wash tank.
4. Fill the reservoir with fresh water.
5. Using the salt funnel supplied fill the reservoir with approximately 1.5kg of granulated salt.
6. Wipe away any excess or spilt salt from the cabinet and the reservoir opening.
7. Refit the cap to the reservoir, ensure that the cap is fitted flat and secure.



**Warning**

**DO NOT** run the machine if there is no salt in the salt reservoir, as this will allow lime scale to build up, also any lime scale will invalidate your warranty

**DO NOT** add any chemicals, such as detergent or rinse aid to the reservoir. These will cause damage to the machine.



**Caution**

**Only use granulated salt** (*max. grain size 5 – 7 mm*). Salt tablets are not suitable.

If the reservoir cap is not properly secured, water and/or chemicals can leak in or out of the unit causing damage to the machine.

### 6.5.2 Setting the water softener

Check the water hardness of your water supply (°d). Once you have this data follow the steps below.

1. Refer to Appendix A to find the setting required for your water hardness (►11).
2. Enter commissioning mode (►6.2)
3. Using the up and down keys (5 & 6), scroll to the water hardness menu item (h\*\*) and press enter (2).
4. The display will flash.
5. Use the up and down keys (5 & 6) to scroll to the setting you require and press enter (2).
6. Press exit (1) until you are out of commissioning mode.

### 6.6 Wash and rinse tank temperatures

The wash and rinse boiler temperatures have been pre-set to temperatures that comply with environmental health standards.

## 7. Operation

Children should be supervised to ensure that they do not play with, or operate the machine.

Before operating the machine, ensure that the mains electrical and water supplies are turned on.

### 7.1 Operation interface

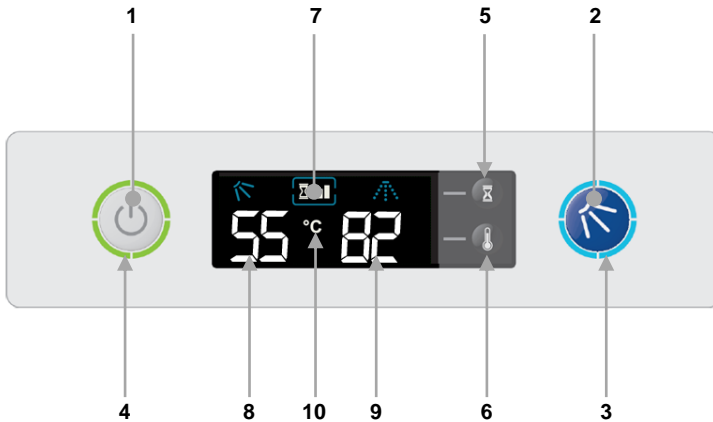

Item	Description
1	On/Off button
2	Cycle button
3	Cycle indicator
4	Heating indicator
5	Program select
6	Temperature units button
7	Program indication
8	Wash temperature
9	Rinse temperature
10	Temperature units display

### 7.2 Turning on the machine

To turn on the machine ensure the door is closed and press the On/Off button (1) on the keypad of the machine, the display will illuminate, the machine will start to fill automatically as long as the door is closed.

### 7.3 Machine ready to operate

Your machine operates a pulse fill function, this means that it will fill the rinse boiler, heat this to a pre-set temperature then transfer this water to the wash tank. During the fill stage the heating indicator (4) will flash amber.

Once the wash tank is filled and both tanks are up to the required temperatures the heating indicator will illuminate green to indicate the machine is ready to run a cycle.

The time required for the machine to fill and heat will vary depending on the power rating of the machine as stated on the rating label (►3.1) and the incoming water temperature, below is a guide to these times when the incoming water is 16°C.

#### 7.4

Rating	Time
220-240V / 1N~ / 13A	50min
220-240V / 1N~ / 28A	25min
380-415V / 3N~ / 11A	25min

#### 7.5 Changing temperature units



The temperature displays (8 and 9) on your machine can be shown in °C or °F (10). Press the temperature unit button (6) to cycle between these options.

#### 7.6 Selecting a wash program



Your machine has multiple program times; these are pre-set to offer the best possible results. To change the program press the program select button (5) until the program display (7) shows the selection you require.

When the machine is turned on (►7.2) it will always start on program the normal program.

##### 7.6.1 Dishwasher program options:

Display	Description	Time (min)
	Normal	3
	Intense	5
	Heavy	8

##### 7.6.2 Glass washer program options:

Display	Description	Time (min)
	Light	1.5
	Normal	2

Your machine has a heat interlock to ensure that the rinse is in accordance with environmental health requirements. This will extend the wash cycle if the rinse boiler has not achieved the required temperature within the cycle times above.

#### 7.7 Loading a basket

##### For dishwashers ONLY

Long cutlery, such as ladles and long knives etc., must be placed horizontally on the open basket this will avoid possible collision with wash/rinse arms.

#### 7.8 Starting a cycle

Always remove excess food/debris from any dishes/glasses to be washed. **DO NOT** use your machine as a waste disposal unit.

To start a cycle, follow the instructions below.

1. Open the door
2. Load the full basket, ensuring that bottom and top arms rotate freely.
3. Close the door
4. Press the cycle button (2). The cycle will start once the machine has achieved its correct water levels and temperatures. During the cycle the blue cycle indicator (3) will be illuminated blue.

Do NOT open the door during a cycle.

If the cycle button is pressed before the machine has reached the required levels the cycle indicator (3) will illuminate blue to indicate that a cycle has been selected, the heating indicator (4) will flash amber and the machine will automatically start when the requirements have been met.

5. At the end of the cycle, once the cycle indicator (3) has gone out. Open the door and remove the basket
6. Reload the machine and repeat as required.

Wares in the basket may be wet and will dry in a short time due to evaporation.



**Warning**

Be aware: Wares may be hot when removed from machine

## 7.9 Draining down the machine



**Caution**

It is very important the machine is drained down at the end of each working day.

During normal operation the machine will drain out any excess water.

To fully drain down the machine follow the below instructions

### 7.9.1 For gravity drain machines:

1. Open the door to the machine.
2. Locate and remove the drain plug (►3.1).

### 7.9.2 For pump drain machines:

1. Close the door to the machine
2. Press the On/Off button (1) to turn off the machine.
3. Press the cycle button (2)
4. The cycle indicator (3) will flash blue.
5. The machine will drain down the wash tank.
6. The machine will do a self-rinse.
7. When the cycle indicator (3) goes out the drain cycle is complete.

### Note!

Once empty **Classeq** recommends the mains water and electricity supplies are turned off and the machine is cleaned (►8.2).

For hygiene reasons it is recommended that once the machine has been drained and cleaned the door is left open to assist in natural drying of the wash chamber.

## 8. Service and maintenance



**DANGER!**

The machine **MUST** be disconnected from its power source during cleaning, servicing or replacing parts.

Ensure the base of the machine is **never** submerged or standing in water when operating the machine.



**Caution**

**DO NOT** spray the exterior or interior of the machine and the surrounding area (*panels, base*) using a water hose, steam-jet air ejector or high-pressure cleaner.

Ensure that the items placed on the open door of the machine do not exceed 20kg in weight.

### 8.1 Prior to cleaning

Ensure the machine has first been drained down (►7.9).

Turn off the mains electrical supply before cleaning the machine.



**Warning**

**DO NOT** use cleaning agents that contain **CHLORINE, BLEACH** or **HYPOCHLORITE**.

Before cleaning the wash chamber, ensure all sharp items, such as broken glass or other items which could cause injury are removed carefully.



**Caution**

**DO NOT** use **STEEL WOOL, WIRE BRUSHES** or any other abrasive materials.

### 8.2 Daily cleaning

It is recommended that the machine is cleaned daily to ensure good hygiene in the machine.

### 8.2.1 Interior cleaning

The interior of the machine should be cleaned after each service when the machine is drained down.

As a minimum **Classeq** recommends the following are checked and cleaned (►3.1):

- Remove and clean top and bottom rinse and wash arms.
- Remove and clean primary filters
- Remove and clean secondary filters.
- Clean interior of the wash tank with a sponge and/or brush for all apertures and outlets.
- Clean around the door hinge
- Use a trigger spray bottle with a jet nozzle to spray the ball in the anti-syphon device.
- If required apply food grade grease to the door ball catch.

Ensure all arms and filters are refitted to the machine before turning it on.

### 8.2.2 Exterior cleaning

Wipe the exterior of the machine with a damp (*NOT WET*) sponge.

Once dry, clean using a **STAINLESS STEEL** cleaning agent.

### 8.3 Lime scale

For best results ensure your machine is operated with soft water ( $\leq 3^{\circ}\text{dH}$ ).

If your machine is connected to an external softener, ensure this is routinely 'regenerated' as per the instruction of the water softener.

If your machine has an internal water softener fitted ensure the salt level is maintained as per the instructions in this manual.

If your machine is operated with hard water without the relevant water treatment, the internal working and all water lines can become 'scaled', your results will deteriorate and the machine could be damaged. For more information on hard water refer to Appendix B (►12).



**Caution**

Damage to the machined caused by lime scale will **NOT** be covered by the manufacturer's warranty (►15).

## 8.4 Regular maintenance

### 8.4.1 Water softener salt (if fitted)

When the salt level inside the water softener reservoir gets low the refill salt indicator will illuminate on the display.

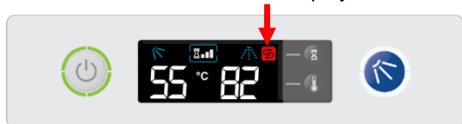

The salt should be replenished as soon as possible to avoid lime scale from building up in your machine.

To refill the salt reservoir follow the instructions below:

1. Open the door to the machine.
2. Remove the right hand basket ramp.
3. Open the salt reservoir cap at the back right hand corner of the wash tank.
4. Using the salt funnel supplied fill the reservoir with granulated salt.
5. Wipe away any excess or spilt salt from the cabinet and the reservoir opening.
6. Refit the cap to the reservoir, ensure that the cap is fitted flat and secure.

**Note:** The refill salt indicator may stay illuminated for up to 3 complete wash cycles after filling/refilling the salt reservoir with salt

7. Drain down the machine to remove the salt water.

**DO NOT** run the machine if there is no salt in the salt reservoir, as this will allow lime scale to build up, also any lime scale will invalidate your warranty

**DO NOT** add any chemicals, such as detergent or rinse aid to the reservoir. These will cause damage to the machine.



**Warning**

**Only use granulated salt** (max. grain size 5 – 7 mm). Salt tablets are not suitable.



**Caution**

If the reservoir cap is not properly secured, water and/or chemicals can leak in or out of the unit causing damage to the machine.

## 8.5 Descaling

You can de-scale the wash tank of your machine yourself with the help of the following notes; to de-scale the rinse boiler you will need to contact your service engineer or **Classeq**.



**Warning**

Wear protective clothing, protective gloves and protective goggles when handling chemicals and observe all safety notes and dosing recommendations printed on their packaging

In order to descale the wash tank follow the instructions below.

1. Remove the chemical tubes from the chemical bottles.
2. Place the ends tubes into a container of water.
3. Use the commissioning menu to prime the rinse aid and detergent pumps for at least 60sec (▶6.4) to draw water all the way into the machine.
4. Fill and drain the machine to remove any chemical residue.
5. Refill the machine.
6. Follow instructions on the chemical packaging to de-scale the wash tank.
7. Once the de-scale process is complete drain the machine.
8. Refill and drain the machine at least 3 times to remove any chemical residue.
9. Refit the chemical tubes to the bottles and prime the pumps (▶6.4).

## 9. Troubleshooting

If you believe the machine is not behaving as expected or has gone into error mode (Cycle indicator illuminated red) reset the machine, by pressing the on/off button, then follow the troubleshooting tips before requesting a service callout. The service support number can be found in the 'Useful contact details' section (▶ 17):

### **NOTE:**

In the event of a service call being made under Warranty and it is found that the fault(s) are due to non-observance of instructions in this manual, the call will be charged at current rates.

### 9.1 Machine will not fill

Your machine operates a pulse fill function, this means that it will fill the rinse boiler, heat this to a pre-set temperature then transfer this water to the wash tank. During the fill stage the heating indicator will flash amber.

If your machine has been in this state for more than 30 minutes the error indicator will illuminate. Check the items below before requesting a service callout:

- Water supply hose is connected to your machine.
- Water supply is turned on.
- Water supply hose has not been trapped or kinked.
- Check that the site water supply has not been interrupted.
- Check the machine is turned on.
- Check the door is closed.

### 9.2 Machine will not turn on

- Machine is connected to a mains power supply.
- Check power supply plug is turned on.
- On 13A machines first check and replace the fuse in the plug, ensuring that the correct rating is used.
- On all ratings of machine check and reset circuit breaker in the site fuse board.
- If the fuse or breaker continues to trip, do not reset and request a service callout.

### 9.3 Machine fills slowly

- Check water supply is turned fully on.
- Check water supply hose has not been trapped or kinked.
- Check that the site water supply has not been interrupted.
- Check site pressure is adequate (▶ 4.3.2).

### 9.4 Machine over filling

If your machine is over filling during the fill cycle attempt to drain the machine (▶ 7.9) and refill before isolating the machine and requesting a service callout.

### 9.5 Machine does not heat

- Machine is turned on (▶ 9.2).
- Machine able to fill (▶ 9.1).
- Enough time has been allowed for the machine to fill and heat (▶ 7.3).

### 9.6 Excessive foam in wash tank

- Chemicals are commercial ware washer grade.
- Chemical dosage is correct.
- Check wash tank has fully heated.

### 9.7 Cycle does not start

Your machine has a heat interlock that will delay the start of the wash cycle until all criteria have been met. When the criteria have been met the heat indicator will illuminate green and the cycle should start.

If this is not the case please check the below items before requesting a service callout.

- Machine is on.
- Enough time has been allowed for the machine to fill and heat (▶ 7.3).
- Wash tank is full of water.

### 9.13 Machine will not turn off

Isolate the machine before requesting a service callout.

### 9.8 Cycle runs for a long time

Your machine has a heat interlock to ensure that the rinse is in accordance with environmental health requirements. This will extend the wash cycle if the rinse boiler has not achieved the required temperature.

### 9.9 Machine does not rinse

If your machine runs through a full cycle, but does not rinse, you will need to request a service call to identify the root cause of the problem.

### 9.10 Machine over flowing

- Drain/stand pipe is correct for the machine (▶5.5).
- Site waste is not blocked.
- Machine waste hose is not kinked or blocked.
- Remove and clean all filters.
- Fully drain and refill machine.
- If the machine continues to overflow isolate the machine and request a service callout.

### 9.11 Poor wash results

- Soft water is supplied to the machine (▶4.3.2).
- The level of chemicals within the rinse aid and detergent bottles and the bottle weights and tubes are correctly positioned.
- Chemical dosing set to the correct concentration levels (▶6.3).
- Machine is regularly cleaned (▶8.2).
- Water softener regenerated (external) or salt reservoir full (internal)
- Glasses may need to be renovated.

### 9.12 Machine does not drain

- The drain/stand pipe is correct for the machine (▶5.5).
- Site waste is not blocked.
- Machine waste hose is not kinked or blocked.
- Correct drain procedure is being used for the machine type (▶7.9).



## 10. Decommissioning

If for any reason you require to remove or decommission your machine do so in accordance with local and national regulations.

As a minimum **Classeq** recommends the following procedure is followed.

Prior to removing any chemicals refer to all safety statements on chemical bottles for dealing with any spillage.

- Remove chemical tubes from the chemical bottles, ensuring the bottles are then capped to prevent any further spillage.
- Ensure the machine is fully drained (▶ 7.9). Once completed remove the waste hose from the drain standpipe; ensure any spilt liquid is dried prior to advancing to the next step.
- Turn off the mains electrical supply at wall / isolator / junction box

When disconnecting your machine from the mains electrical supply:

- Machines with an electrical plug, always pull the plug. Never pull the cord itself.



- Machines hard wired (i.e. no plug), this must be disconnected in accordance with local and national regulations; **Classeq** recommends this is performed by a qualified electrician.



- Once the electrical supply has been disconnected, ensure the equipotential wire is removed from the stud at the rear of the machine.
- Turn off the water supply to the machine and disconnect the water supply hose from mains water supply, ensuring any spillage is dried prior to moving onto next step.
- Remove the front lower panel using a 3mm hex key.
- Now locate the '*Boiler drainage hose*' as shown. Ensure this protrudes from the front of the machine and you have a container large enough to hold 8 litres of water.



### Warning

If the machine is being drained immediately after use, water draining from the '*Boiler drainage hose*' may reach up to **95°C**.

- Loosen the jubilee clip and remove the drain plug, ensuring the water flows into the container mentioned above. Once fully drained replace the drain plug and retighten the jubilee clip.
- Replace the front panel, and ensure all cables and hoses are secured to the machine to prevent tripping hazards. The machine is now ready to be removed.



**RECYCLING** If you are recycling or disposing of your machine, you must ensure this is done in accordance with local and national regulations.

## 11. Appendix A – Water softener settings

Water softener setting	°dH	°e / °clark	°fH	ppm
h00	Deactivated			
h01	1	0.8	0.6	18
h02	2	1.6	1.1	36
h03	3	2.4	1.7	54
h04	4	3.2	2.2	71
h05	5	4.0	2.8	89
h06	6	4.8	3.4	107
h07	7	5.6	3.9	125
h08	8	6.4	4.5	143
h09	9	7.2	5.0	161
h10	10	8.0	5.6	179
h11	11	8.8	6.2	196
h12	12	9.6	6.7	214
h13	13	10.4	7.3	232
h14	14	11.2	7.8	250
h15	15	12.0	8.4	268
h16	16	12.8	9.0	286
h17	17	13.6	9.5	303
h18	18	14.4	10.1	321
h19	19	15.2	10.6	339
h20	20	16.0	11.2	357
h21	21	16.8	11.8	375
h22	22	17.6	12.3	393
h23	23	18.4	12.9	411
h24	24	19.2	13.4	428
h25	25	20.0	14.0	446
h26	26	20.8	14.6	464
h27	27	21.6	15.1	482
h28	28	22.4	15.7	500
h29	29	23.2	16.2	518
h30	30	24.0	16.8	536

## 12. Appendix B – Water hardness explained

Water hardness occurs because certain chemicals in the rocks through which it passes on its way to the consumer are slowly dissolved into the water.

The problem shows itself in two forms. First, when hard water is heated the chemicals come out of solution and appear as solid particles (lime scale) that are carried round the machine. These particles are formed most quickly at the hottest part of the machine – normally the rinse element and the rinse tank in general. This is why the rinse tank is the best place to look to judge if lime scale is being formed in a machine.

Second, most commercial chemicals operate much less efficiently in hard water, and this will often show as poor results or failure to remove tannin stains, or condensation on glasses. Tannin stains appear to cling to the hard water film in the drink, which then clings to the surface of the cup or saucer. With soft water this is not the case.

Some types of hard water do not produce lime scale when heated, but it will still reduce the performance of the chemicals, as mentioned above. This is known as permanent hardness. Temporary hardness is when the hardness can be largely removed by conversion into lime scale by boiling.

If lime scale is produced inside a machine it will cause a number of maintenance problems, for example:

- Coating of element leading to slow heating and element failure
- Blockage of rinse jets showing as poor results
- Wear of bushes in centre boss, showing as poor results and possibly wash water passing backwards into the rinse system.
- Blockage of rinse-aid injection point in boiler.
- White marks may appear on glasses, dishes and cutlery.



- Dishes or cups may appear dirty even after a wash. Especially coffee or tea cups.
- Discolouration of inside of machine, making cleaning difficult.



- Blockage of hoses due to the deposit “furring up” the inside of the hose.

When lime scale is found, it must be removed with commercial De-scale, used with care in accordance with the instructions on the product. The descale instructions in this manual should always be followed. The rinse tank is difficult to de-scale and may require a service engineer.

Your local water board should be able to tell you if the water in your area is hard or soft. As a guide refer to the map in Appendix C (►13).

### 13. Appendix C – Water hardness map

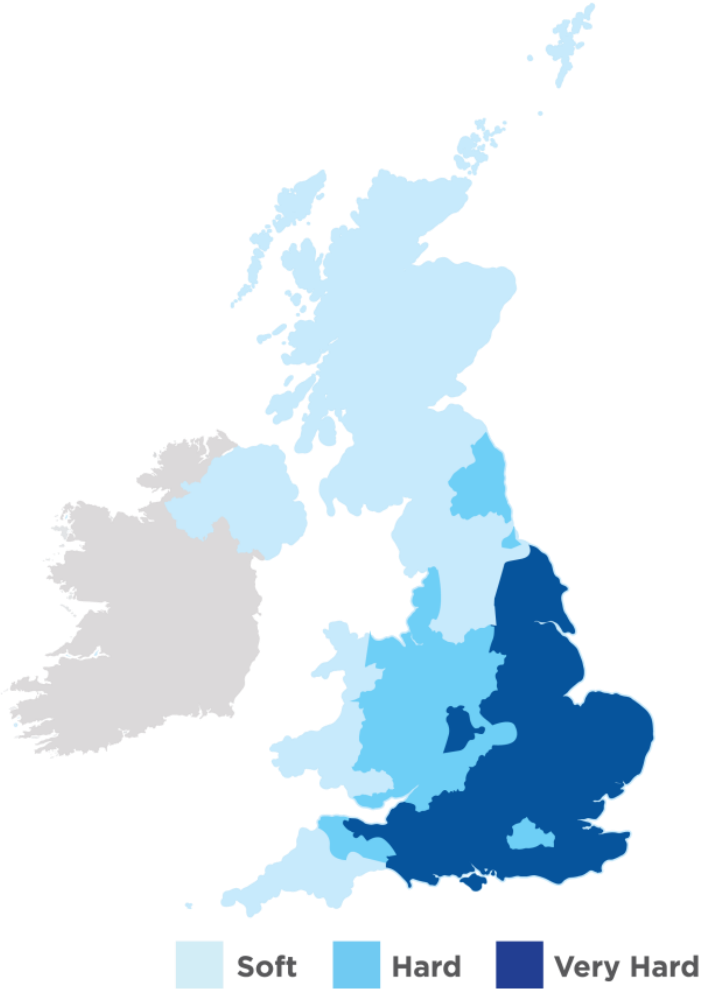

Map 1 - Water hardness map<sup>12</sup>

For more detailed information regarding your water hardness, please contact your water supplier.

---

<sup>12</sup> Correct at time of going to print

# 14. Appendix D – Machine specifications

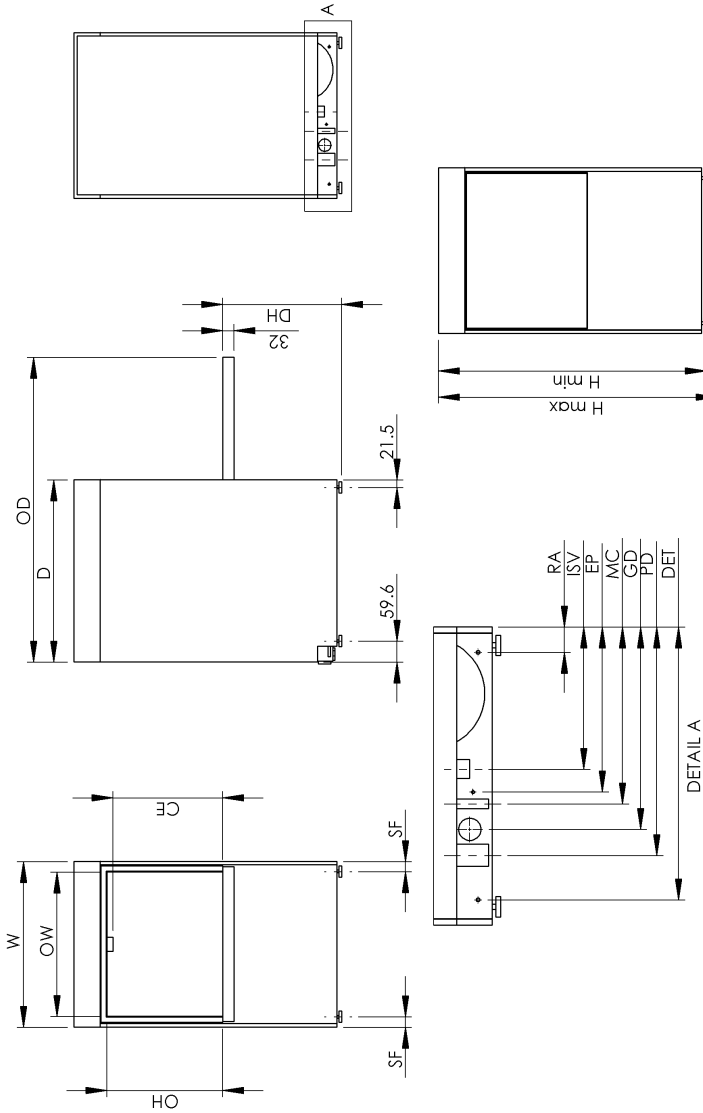

Number	H (mm)		W (mm)	D (mm)	SF (mm)	OH (mm)	OW (mm)	CE (mm)	OD (mm)	DH (mm)	e (kg)		G (No.)	D (No.)	Δ (°C)			RA (mm)	ISV (mm)	EP (mm)	MC (mm)	GD (mm)	PD (mm)	DET (mm)	dB(A)
	Max	Min									E	F			T1	T2	T3								
90000287	674	644	410	517	19	278	369	273	810	272	32	43.5	12	N/A	55	70	N/A	30	208	338	308	253	265	380	<70
90000288	790	760	450	517	19	328	409	311	865	338	33.5	50	16	9	55	70	82	30	214	250	269	309	350	420	<70
90000289	790	760	470	517	29	328	409	311	865	338	40.3	46.8	16	9	55	70	82	40	224	260	279	319	360	430	<70
90000290	860	830	550	605	19	361	509	343	987	375	44	64.5	25	18	55	70	82	30	221	324	289	375	435	520	<70
90000291	860	830	570	605	29	361	509	343	987	375	54.7	75.2	25	18	55	70	82	40	231	334	299	385	445	530	<70

## 14.1 Legend<sup>13</sup>

Item	Description
90000287	G350
90000288	D400; G400
90000289	D400 DUO; G400 DUO; D400 DUO WS; G400 DUO WS
90000290	D500; G500
90000291	D500 DUO; G500 DUO; D500 DUO WS; G500 DUO WS
H	Height of machine
W	Width of machine
D	Depth of machine
SF	Foot dimension to side
OH	Door opening height
OW	Door opening width
CE	Clear entry height
OD	Depth with door open
DH	Door open height
E	Empty weight
F	Full weight
G	Pint glasses per rack
D	Dishes per rack
T1	Wash water temperature
T2	Glass washer rinse temperature
T3	Dish washer rinse temperature
↻	Noise level

## 14.2 Supply locations

Description	Symbol	Radius from machine (m)
Rinse aid tube	RA	3
Inlet solenoid valve	ISV	1.8
Mains electrical cable	EC	1.3
Gravity waste water outlet	GD	1.5
Pumped waste water outlet	PD	1.5
Equipotential bonding stud	EP	-
Detergent tube	DET	3

<sup>13</sup> A minimum of 10mm air gap should be left on both side and on top of the machine and 20mm at the rear.

## 15. Parts and Labour warranty

### **Classeq Ltd.**

#### Parts and Labour Warranty Terms

The user is entitled to free replacement and fitting of any part found to be faulty in material or workmanship, including any parts rendered inoperative by the effect of a faulty component, for a period of one year, or as specified by the vendor at the time of purchase.

#### Exceptions

All faults or conditions caused by Operator misuse, including (but not exclusively):

- Incorrect Installation.
- No fault found.
- Problems with electricity supply or plumbing e.g. water and waste.
- Failure to follow instructions in the User Handbook.
- Use of incompatible chemicals or chemical set at incorrect concentration.
- Drain pump or drain system blocked or damaged by foreign bodies.
- Wash pumps damaged due to foreign bodies entering the wash system.
- Use of un-softened (hard) water. The use of a faulty water softener or the failure to properly regenerate a water softener.
- Use of excessive force on the machine, e.g. switches etc.
- The cost of replacing any item found to be lost or missing.
- Use of non-compatible cleaning materials.
- Incorrect assembly after cleaning.
- Damage to machine caused by any 3<sup>rd</sup> party.









**17. Useful contact details**

To help when contacting please quote the serial number and model of machine

**Classeq Ltd.**  
Classeq house  
Airfield Industrial estate  
Hixon  
Staffordshire  
ST18 0PF  
United Kingdom

Document number: 10021366  
Revision: C  
Date: 06/01/2017  
Language: English  
Original instructions