

COBRA®

Gas Cooktops

Models:

C6 (600mm)

C9 (900mm)



INSTALLATION AND OPERATION MANUAL

MANUFACTURED BY

Moffat Limited

Rolleston 7675
New Zealand

INTERNATIONAL CONTACTS

AUSTRALIA

Moffat Pty Limited

E.Mail: vsales@moffat.com.au
Main Office: (tel): +61 (03) 9518 3888
(fax): +61 (03) 9518 3833
Service: (tel): 1800 622 216
Spares: (tel): 1800 337 963
Customer Service: (tel): 1800 335 315
(fax): 1800 350 281

CANADA

Serve Canada

Web: www.servecanada.com
E.Mail: info@servecanada.com
Sales: (tel): 800 551 8795 (Toll Free)
Service: (tel): 800 263 1455 (Toll Free)

NEW ZEALAND

Moffat Limited

Web: www.moffat.co.nz
E.Mail: sales@moffat.co.nz
Main Office: (tel): 0800 663328

UNITED KINGDOM

Blue Seal

Web: www.blue-seal.co.uk
E.Mail: sales@blue-seal.co.uk
Sales: (tel): +44 121 327 5575
(fax): +44 121 327 9711
Spares: (tel): +44 121 322 6640
(fax): +44 121 327 9201
Service: (tel): +44 121 322 6644
(fax): +44 121 327 6257

UNITED STATES

Moffat

Web: www.moffat.com
Sales: (tel): 1800 551 8795 (Toll Free)
(tel): +1 336 661 1556
(fax): +1 336 661 9546
Service: (tel): 866 673 7937 (Toll Free)
(tel): +1 366 661 1556
(fax): +1 336 661 1660

REST OF WORLD

Moffat Limited

Web: www.moffat.co.nz
E.Mail: export@moffat.co.nz

The reproduction or copying of any part of this manual by any means whatsoever is strictly forbidden unless authorized previously in writing by the manufacturer.

In line with policy to continually develop and improve its products, Moffat Ltd. reserves the right to change the specifications and design without prior notice.

Contents

C6	Gas Cooktops - 600mm Wide, Standard (Cabinet).	
C6-B	Gas Cooktops - 600mm Wide, Benchtop.	
C9	Gas Cooktops - 900mm Wide, Standard (Cabinet).	
C9-B	Gas Cooktops - 900mm Wide, Benchtop.	
Part 1	Introduction	2
Part 2	Specifications	3
	Model Numbers Covered in this Specification	
	General	
	Gas Supply Requirements	
	Gas Connection	
	Dimensions	
Part 3	Installation.....	6
	Installation Requirements	
	Unpacking	
	Assembly	
	Location	
	Clearances	
	Gas Connection	
	Commissioning	
Part 4	Operation.....	9
	Operation Guide	
	Description of Controls	
	Open Burners	
	Lighting the Open Burners	
	Griddle	
	Lighting the Griddle	
Part 5	Cleaning and Maintenance	11
	General	
	After Each Use	
	Daily Cleaning	
	Weekly Cleaning	
	Periodic Maintenance	
Part 6	Fault Finding.....	14
Part 7	Gas Conversion.....	16
	Gas Conversion Procedure	
	Gas Specifications	
Part 8	Replacement Parts List.....	20

Part 1 Introduction

We are confident that you will be delighted with your **Cobra Series** Cooktop, and it will become a most valued appliance in your commercial kitchen.

To ensure you receive the utmost benefit from your new **Cobra Series** Appliance, there are two important things you can do.

Firstly:

Please read this instruction book carefully and follow the directions given. The time taken will be well spent.

Secondly:

If you are unsure of any aspect of the installation instructions or performance of your appliance, contact your **Cobra Series** dealer promptly. In many cases a phone call could answer your question.

CE Only:

These instructions are only valid if the country code appears on the appliance. If the code does not appear on the appliance, refer to the supplier of this appliance to obtain the technical instructions for adapting the appliance to the conditions for use in that country.

WARNING:

IMPROPER INSTALLATION, ADJUSTMENT, ALTERATION, SERVICE OR MAINTENANCE CAN CAUSE PROPERTY DAMAGE, INJURY OR DEATH. READ THE INSTALLATION, OPERATING AND MAINTENANCE INSTRUCTIONS THOROUGHLY BEFORE INSTALLING OR SERVICING THIS APPLIANCE.

WARNING:

INSTRUCTIONS TO BE FOLLOWED IN THE EVENT THAT THE USER SMELLS GAS ARE TO BE POSTED IN A PROMINENT LOCATION. THIS INFORMATION CAN BE OBTAINED BY CONSULTING THE LOCAL GAS SUPPLIER.

WARNING:

GREAT CARE MUST BE TAKEN BY THE OPERATOR TO USE THE EQUIPMENT SAFELY TO GUARD IT AGAINST RISK OF FIRE.

- **THE APPLIANCE MUST NOT BE LEFT 'ON' UNATTENDED.**
- **IT IS RECOMMENDED THAT A REGULAR INSPECTION IS MADE BY A COMPETENT SERVICEMAN TO ENSURE THAT CORRECT AND SAFE OPERATION OF YOUR APPLIANCE IS MAINTAINED.**
- **DO NOT STORE OR USE GASOLINE OR OTHER FLAMMABLE VAPOURS OR LIQUIDS IN THE VICINITY OF THIS OR ANY OTHER APPLIANCE.**
- **DO NOT SPRAY AEROSOLS IN THE VICINITY OF THIS APPLIANCE WHILE IT IS IN OPERATION.**

CAUTION:

This appliance is:

- **For professional use and is to be used by qualified persons only.**
- **Only Qualified service persons are to carry out installation, servicing and gas conversion operations.**
- **Components having adjustments protected (e.g. paint sealed) by the manufacturer should not be adjusted by the user / operator.**
- **DO NOT operate the appliance without the legs supplied fitted.**

Model Covered in this Specification -

C6D[1]-[2]	Cooktop	4 Open Burners.
C6C[1]-[2]	Cooktop	2 Burners + 300mm Griddle.
C6B-[2]	Cooktop	600mm Griddle.
C9D[1]-[2]	Cooktop	6 Open Burners.
C9C[1]-[2]	Cooktop	4 Burners + 300mm Griddle.
C9B[1]-[2]	Cooktop	2 Burners + 600mm Griddle.
C9A-[2]	Cooktop	900mm Griddle.

[1] - Open Burner Options;

- Standard Option.
- F - Flame Failure Protection.

[2] - Model Configuration Options;

- Standard (Cabinet).
- B - Benchtop.

General

A heavy duty, high efficiency Cooktop for modular kitchens. It has a high option Cooktop / Griddle arrangement and is available on adjustable front feet and robust rear rollers. Five griddle options with 2 models of base unit are available. Open Burners have either Standard or with Flame Failure Protection as an option.

Griddles are available in 300mm, 600mm and for the C9 Gas Cooktop, a 900mm option is available. All griddle options are fitted with pilot, flame failure and piezo ignition as standard.

Gas Supply Requirements

- United Kingdom:

		Natural Gas (G20)		Propane (G31)	
		Open Burner (each)	Griddle (each 300mm section)	Open Burner (each)	Griddle (each 300mm section)
Heat Input (net)	Nominal	5.0 kW	5.0 kW	4.6 kW	5.0 kW
	Reduced	1.7 kW	1.5 kW	1.5 kW	2.2 kW
Gas Rate (net)	Nominal	0.53 m ³ /hr	0.53 m ³ /hr	0.36 kg/hr	0.39 kg/hr
	Reduced	0.18 m ³ /hr	0.16 m ³ /hr	0.12 kg/hr	0.17 kg/hr
Supply Pressure		20 mbar		37 mbar	
Burner Operating Pressure (*)		10 mbar		28 mbar	
Gas Connection		¾" BSP Male			

NOTE:

- (*) Measure burner operating pressure at manifold test point with two burners operating at the 'High Flame' setting.
- NAT & Propane Only - Operating pressure is ex-factory set and is not to be adjusted, apart from when converting between gases, if required. (Refer to 'Gas Conversion' section for further details).
- Refer to the 'Gas Conversion and Specifications' section in this manual for further details.

Gas Connection

Cabinet Models;

Gas supply connection point is located at rear of appliance, approximately 130mm from right hand side and 655mm from floor. It is reached from beneath the appliance. (Refer to 'Dimensions' drawings).

Benchtop Models;

Gas supply connection point is located at rear of appliance, approximately 130mm from right hand side and 60mm from floor. It is reached from beneath the appliance. (Refer to 'Dimensions' drawings).

Connection is ¾" BSP male thread (for all models).

Part 2 Specifications

Dimensions

C6 - Gas Cooktop - Standard (Cabinet), 600mm Wide.

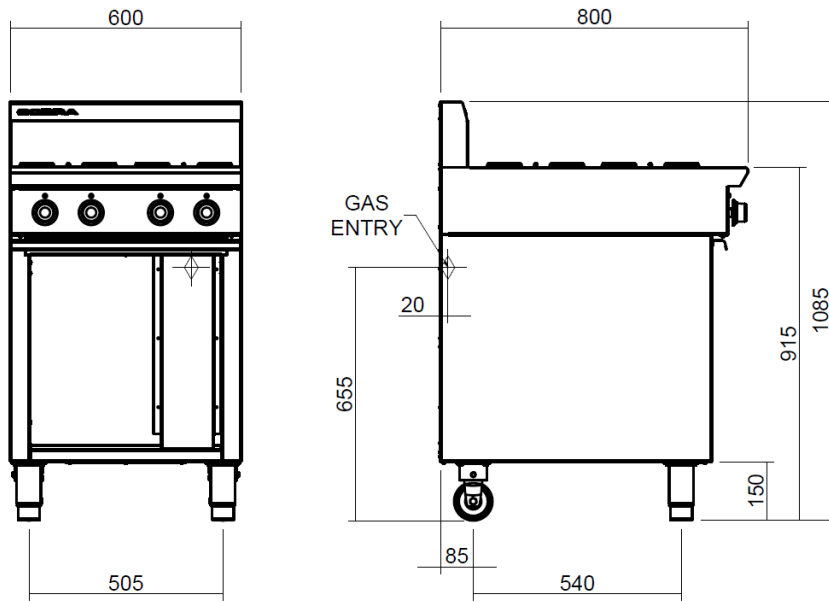

C6-B - Gas Cooktop - Benchtop, 600mm Wide.

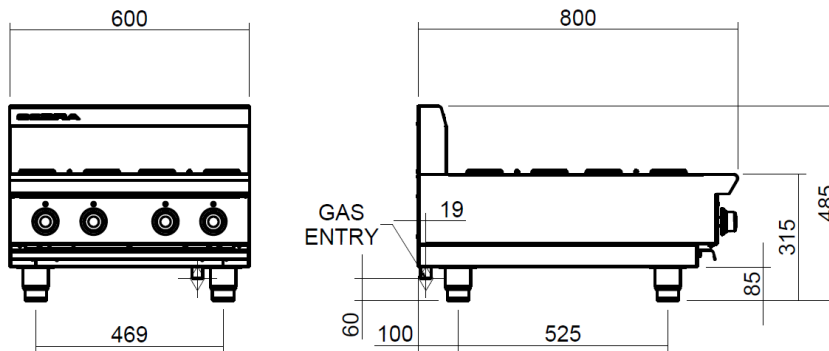

Plan View - 600mm Wide.

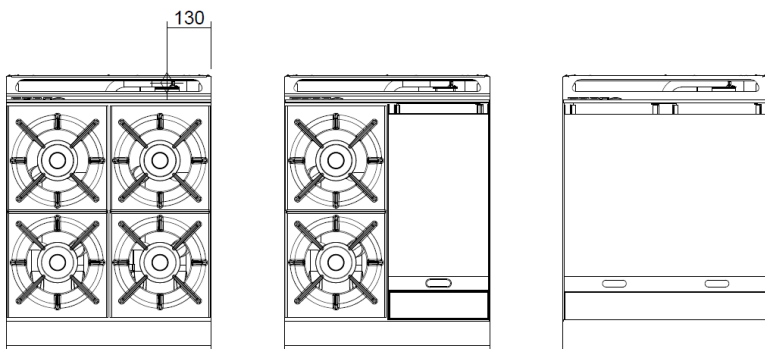

C6D(-B)

C6C(-B)

C6B(-B)

Part 2 Specifications

Dimensions

C9 - Gas Cooktop - Standard (Cabinet), 900mm Wide.

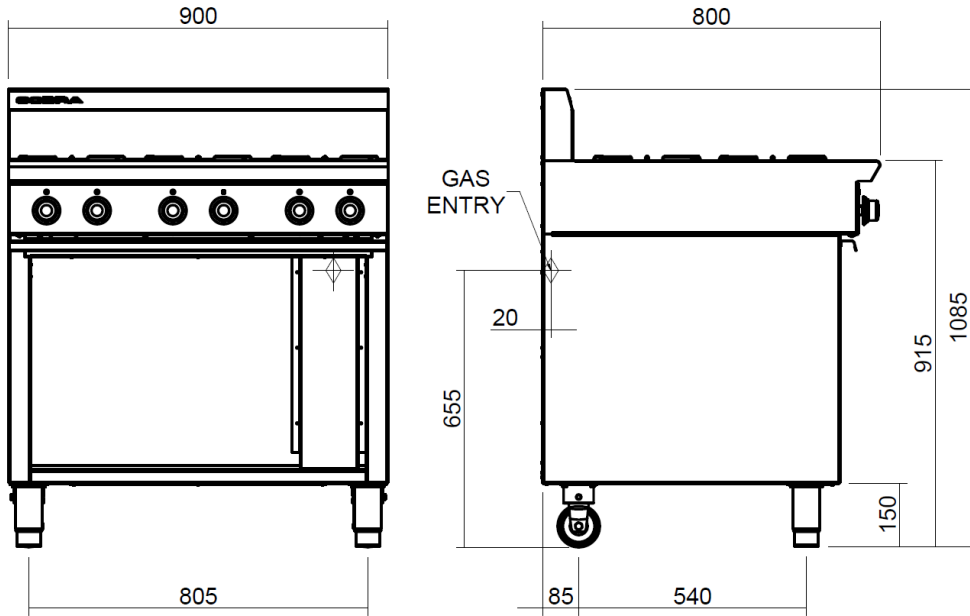

C9-B - Gas Cooktop - Benchtop, 900mm Wide.

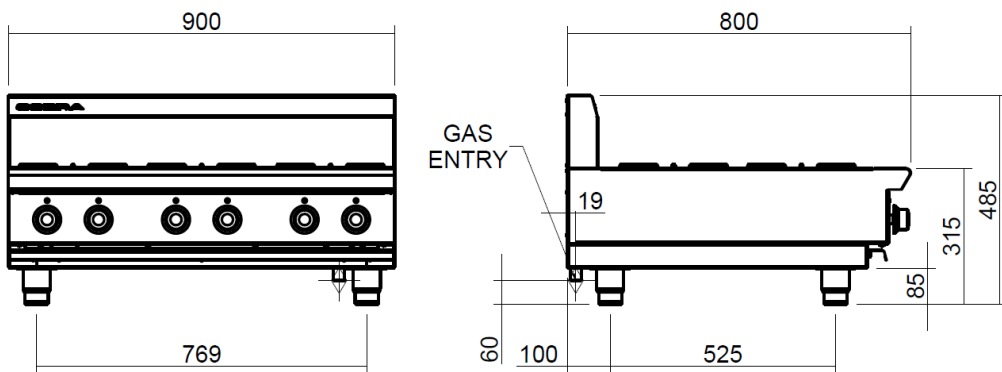

Plan View - 900mm Wide.

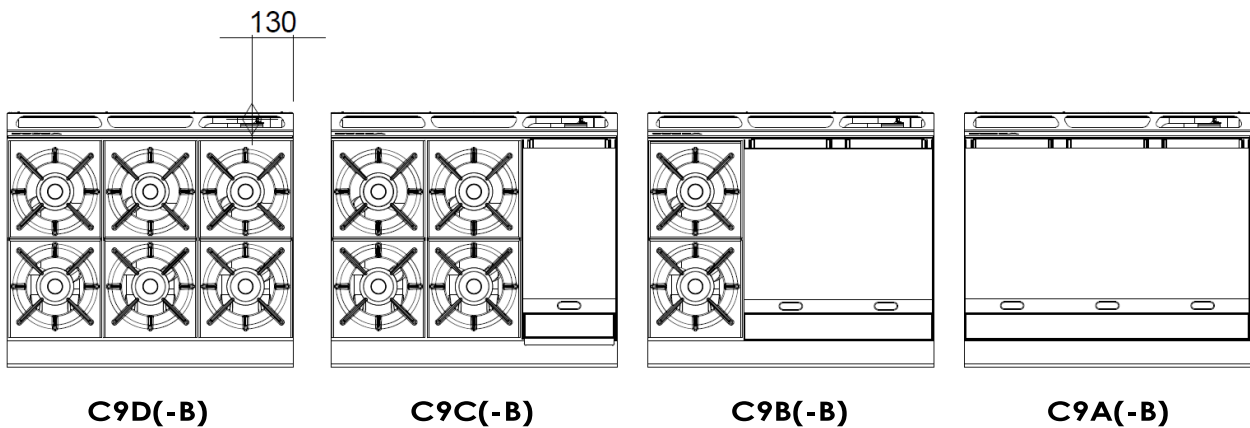

Installation Requirements

NOTE:

It is most important that this appliance is installed correctly and that the operation is correct before use. Installation shall comply with local, gas and health and safety requirements.

This appliance shall be installed with sufficient ventilation to prevent the occurrence of unacceptable concentrations of health harmful substances in the room, that the appliance is installed in.

Cobra Series Cooktops are designed to provide years of satisfactory service and correct installation is essential to achieve the best performance, efficiency and trouble-free operation.

This appliance must be installed in accordance with National installation codes and in addition, in accordance with relevant National / Local codes covering gas and fire safety.

United Kingdom:

Gas Safety (Installation and Use) Regulations 1998.

BS6173 - Installation of Catering Appliances.

BS5440 1 & 2 - Installation Flueing & Ventilation.

Ireland:

IS 820 - Non Domestic Gas Installations.

Installations must be carried out by qualified service persons only. Failure to install equipment to the relevant codes and manufacturer's specifications shown in this section will void the warranty.

Components having adjustments protected (e.g. paint sealed) by manufacturer, are only to be adjusted by a qualified service agent. They are not to be adjusted by the installation person.

Unpacking

- Remove all packaging and transit protection from the appliance including all protective plastic coating from the exterior stainless steel panels.
- Check equipment and parts for damage. Report any damage immediately to the carrier and distributor.
- Report any deficiencies to the distributor who supplied the appliance.
- Check that the available gas supply is correct to that shown on rating plate located on the front upper right hand corner of the cooktop cabinet.

Assembly

If the Legs and Rear Rollers are not fitted, carry out the procedure below to fit Front Legs and Rear Rollers.

NOTE:

This appliance is fitted with adjustable feet to enable the appliance to be positioned securely and level. This should be carried out on completion of the gas connection.

Fitting Front Legs and Rear Rollers.

1. Remove all loose components from the top of the cooktop.
2. Remove screws securing transit plates to the front corners of the transit pallet.

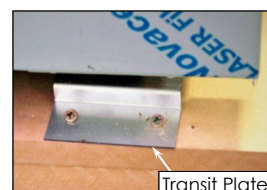

3. Tilt the oven onto it's back and unscrew the transit bolts from the front leg mounting plates.

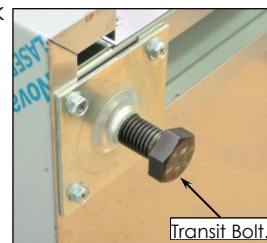

4. Remove front legs from carton and screw onto the front leg mounting plates.



NOTE:

The front legs are adjustable. Once the rear rollers are fitted and the appliance is in it's operating position, the front legs can be adjusted to level the appliance.

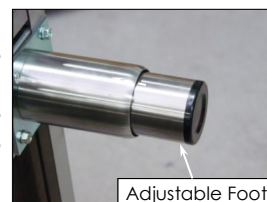

5. Remove rear rollers from carton and attach to rear leg ring plate. Secure with 10mm bolts supplied.



6. Lift appliance back onto it's legs / rollers.
7. Place the cooktop in its final operating position and use the adjustable feet to level the appliance.
8. Refit all items removed at Item 1 above.

Location

1. This appliance must be installed in a suitably ventilated room to prevent dangerous build up of combustion products.
2. Installation must allow for a sufficient flow of fresh air for the combustion air supply.

Combustion Air Requirements		
	C6 Cooktop	C9 Cooktop
Natural Gas	23 m ³ /hr minimum	34 m ³ /hr minimum
Propane	24 m ³ /hr minimum	36 m ³ /hr minimum

3. Installation must include adequate ventilation means, to prevent dangerous build up of combustion products.
4. Never directly connect a ventilation system to the appliance flue outlet.
5. Position the appliance in its approximate working position.
6. All air for burner combustion is supplied from underneath the appliance. The legs must always be fitted and no obstructions placed on the underside or around the base of the appliance, as obstructions will cause incorrect operation and / or failure of the appliance.
7. Components having adjustments protected (e.g. paint sealed) by manufacturer are only allowed to be adjusted by a qualified service agent. They are not to be adjusted by the installation person.

NOTE:

Do not obstruct or block the appliance flue. Never directly connect a ventilation system to the appliance flue outlet.

Clearances

NOTE:

Only non-combustible materials can be used in close proximity to this appliance.

Any gas burning appliance requires adequate clearance and ventilation for optimum and trouble-free operation. The following minimum installation clearances are to be adhered to:

	Combustible Surface	Non Combustible Surface
LH / RH Side	250mm (*)	0mm
Rear	100mm	0mm

* Side clearances can be 50mm when adjacent surface is at least 100mm below cooking surface.

Gas Connection

NOTE:

ALL GAS FITTING MUST ONLY BE CARRIED OUT BY A QUALIFIED SERVICE PERSON.

1. **Cobra Series Cooktops** do not require an electrical connection, they function totally on the gas supply only.
2. It is essential that the gas supply is correct for the appliance to be installed and that adequate supply pressure and volume are available. The following checks should be made before installation:-
 - a. **The Gas Type** the appliance has been supplied for is shown on coloured stickers located above the gas entry point and next to the rating plate. Check that this is correct for the gas supply the appliance is being installed for. The gas conversion procedure is detailed in the Gas Conversion Instruction Sheet for this appliance.
 - b. **Supply Pressure** required for this appliance is shown in the 'Specifications' section of this manual. Check the gas supply to ensure that adequate supply pressure exists.
 - c. **Input Rate** of this appliance is also shown on the Rating Plate located on the front upper right hand corner of the cooktop cabinet and in the 'Specifications' section of this manual. The input rate should be checked against the available gas supply line capacity. **Particular note should be taken if the appliance is being added to an existing installation.**

NOTE:

It is important that adequately sized piping runs directly to the connection joint on the appliance, with as few tees and elbows as possible to give maximum supply volume.

3. Fit the gas regulator supplied, into the gas supply line as close to the appliance as possible.

NOTE:

For Natural Gas and Propane Gas, the pressure regulator provided with this appliance is convertible between these gasses as per the 'Gas Conversion Section' in this manual.

Ensure the regulator is converted to the correct gas type that the appliance will operate on.

The regulator outlet pressure is fixed ex-factory for the gas type that the regulator is converted to and it is NOT to be adjusted.

The regulator connections are 3/4" BSP female.

The connection to the appliance is 3/4" BSP male.

(Refer to the 'Specifications' Section for the gas supply location dimensions).

NOTE:

A Manual Isolation Valve must be fitted to the individual appliance supply line.

4. Correctly locate the appliance into its final operating position and using a spirit level, adjust the legs so that the appliance is level and at the correct height.
5. Connect the gas supply to the appliance. A suitable joining compound which resists the breakdown action of LPG must be used on every gas line connection, unless compression fittings are used.
6. Check all gas connections for leakages using soapy water or other gas detecting equipment.

WARNING:

DO NOT USE A NAKED FLAME TO CHECK FOR GAS LEAKAGES.

7. Check that gas supply pressure is as shown in 'Specifications' section, 'Gas Supply Requirements'.

NOTE:

The supply pressure is to be measured at the manifold test point with 2 burners operating at the 'High Flame' setting.

8. Light the Main Burners. Refer to the 'Operations' Section', 'Open Burners'.
9. Verify that the supply pressure is still correct.
10. Check that the Main Burner is alight and adjust the low fire adjustment screw on the open burner gas control valves to obtain the desired flame size.
11. Check / adjust the main burner aeration gap. This gap should be set to the dimensions shown in the 'Gas Specification Tables' in 'Part 7 - Gas Conversion'.

NOTE:

This appliance is fitted with adjustable feet to enable the appliance to be positioned securely and level. This should be carried out on completion of the gas connection.

Commissioning

The following commissioning checks must be carried out before the appliance is handed over for use, to ensure that the unit operates correctly and the operator(s) understand the correct operating procedure.

1. Before leaving the new installation;
 - a. Check the following functions in accordance with the operating instructions specified in the 'Operation' section of this manual.
 - Lighting the Griddle.
 - Lighting the Open Burners (Standard or with Flame Failure Option).
 - Check the Low Fire Burner Operation.
 - b. Ensure that each operator has been instructed in the areas of correct lighting, operation, and shutdown procedure for the appliance.
2. This manual must be kept by the owner for future reference and a record of the **Date of Purchase**, **Date of Installation** and **Serial Number of the Appliance** recorded and kept with this manual. (These details can be found on the Rating Plate located on the front upper right hand corner of the cooktop cabinet.

NOTE:

If it is not possible to get the appliance to operate correctly, shut 'Off' the gas supply and contact supplier of this appliance.

Operation Guide

CAUTION:

- This appliance is for professional use and is only to be used by qualified persons.
- Only qualified service persons are allowed to carry out installation, servicing or gas conversion operations.
- Components having adjustments protected (e.g. paint sealed) by the manufacturer should not be adjusted by the user / operator.

1. **Cobra** appliances have been designed to provide simplicity of operation and 100% safety protection.

2. Improper operation is therefore almost impossible, however bad operation practices can reduce the life of the appliance and produce a poor quality product. To use this appliance correctly please read the following sections carefully:-

- Lighting the Open Burners (Standard / Flame Failure Option).
- Lighting the Griddle.

Description of Controls

(C9-900mm Gas Cooktop with Griddle Option)

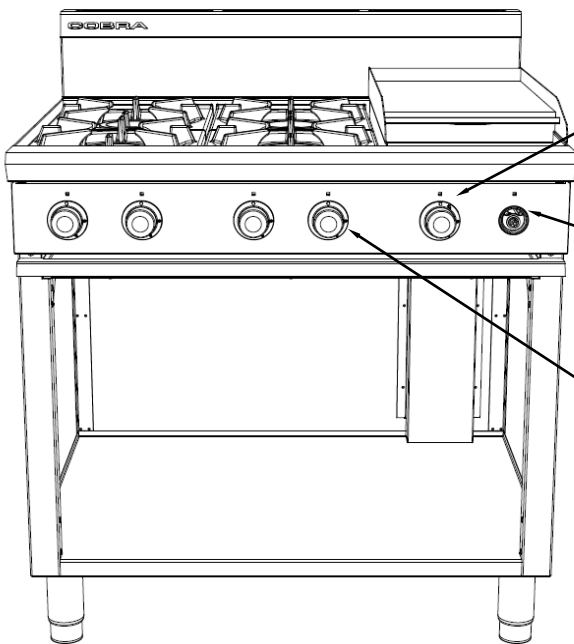

Gas Control Knobs

Griddle.

- OFF Position
- ★ PILOT Burner
- △ HIGH Flame
- △ LOW Flame

Piezo Igniter (Griddles Only)

Open Burners (Std / F)

- OFF Position
- △ HIGH Flame
- △ LOW Flame

▲ Rear Burner

▼ Front Burner

(Indicators located above the Gas Control Knobs).

Open Burners

NOTE: Only cooking pans from size Ø 150mm to Ø 420mm are suitable for use on these open burners.

Lighting the Open Burners (Standard / Flame Failure Options)

- Select the burner required, depress and turn the corresponding gas control knob anti-clockwise to the 'HIGH' position.
- With the gas control knob depressed, manually light the burner.
- Release the gas control knob after approximately 10-20 seconds after lighting the burner.
- The burner should stay alight - if not, repeat Steps (a) to (c) above.
- To achieve simmer control, depress the gas control knob and rotate between the 'HIGH' and 'LOW' positions to achieve the temperature required.

Turning 'OFF' the Open Burners

- When the main burner is not required, depress and turn the gas control knob clockwise back to the 'OFF' position. The 'MAIN' burner will extinguish.

Griddle

CAUTION:

The griddle plate temperature reaches over 300°C in hottest points during normal operation at 'Full Flame' setting.

These griddles are fitted with a pilot as a standard option and Flame Failure Protection, which is incorporated by way of a thermo-electric system for each main burner. Flame Failure Protection will shut off the gas supply to that burner in the event that the pilot for that burner goes out, so that un-burnt gas is not expelled. **This is an important safety feature which is slowly becoming law throughout the world.**

Lighting the Griddle Burner

! IMPORTANT

Always ensure that the grease tray is emptied regularly and never allow the grease tray to overflow.

- Depress the gas control knob and rotate anti-clockwise to the 'PILOT' position.
- With the gas control knob depressed, press the piezo ignition button to ignite the pilot burner. Repeat Items 1 to 2 until the pilot is lit.
- Release the gas control knob approximately 10 to 20 seconds after lighting the pilot.
- The pilot should now remain alight - if not, repeat Steps (a) to (c) above.
- 'Full Flame' can now be achieved by depressing and rotating the gas control knob anti-clockwise to the first stop.
- Low flame can be achieved by depressing gas control knob and rotating fully anti-clockwise to the 'Low Flame' position.
- To turn 'OFF' the griddle main burner, but keep the pilot burner alight, rotate the gas control knob to the 'PILOT' position. The griddle burner will extinguish and the pilot will remain alight.

Turning 'OFF' the Griddle Burner / Pilot

- To turn 'OFF' the 'PILOT', depress and turn gas control knob clockwise back to the 'OFF' position. The 'PILOT' burner will extinguish.

General

CAUTION:

Always turn off the gas supply at the mains supply before cleaning. This appliance is not water proof. Do not use water jet spray to clean interior or exterior of this appliance.

Clean the Cooktop regularly. A clean Cooktop looks better, will last longer and will perform better. Carbonised grease on the surface or between the trivets, griddle plates will hinder the transfer of heat from the cooking surface to the food. This will result in loss of cooking efficiency.

NOTE:

NEVER use a ribbed scraper blade on the flat surfaced griddle plate.

DO NOT use water on the trivets, burners and griddle plates while these items are still hot as warping and cracking may occur. Allow these items to cool down and then remove for cleaning. The entire trivets, griddle plates and burner caps can be dismantled for cleaning.

NOTE:

- **DO NOT use abrasive detergents, strong solvents or caustic detergents as they could corrode or damage the Cooktop.**
- **In order to prevent the forming of rust on the trivets, griddle plate (If fitted) and burners, ensure that any detergent or cleaning material has been completely removed after each cleaning. The appliance should be switched 'On' briefly to ensure that the griddle plates become dry. Oil or grease should be spread over the griddle surface in order to form a thin protective greasy film.**

To keep your Cooktop clean and operating at peak efficiency, follow the procedures shown:-

After Each Use

CAUTION:

Always ensure that if using a flat scraper tool on the griddle surface, an even pressure is applied over the whole surface of the scraper tool to prevent scoring of the surface.

NEVER bang the sharp edge of the scraper tool on the flat surface of the griddle as this will damage the griddle and invalidate the warranty.

1. Clean the griddle and cooktop castings using a scraper tool to remove any build up of carbon.

2. Always ensure that the scraper tool blades are changed regularly to ensure that the scraper tool works efficiently and prevents damage to the griddle plate surface.
3. Clean the range castings with a stiff nylon brush or a flexible spatula to remove any food debris.

Daily Cleaning

1. The grease / spill tray(s) should be checked and emptied frequently to prevent overflow and spillage. Remove the spill tray(s) while still warm so that the grease is in a liquid state. Empty any grease from the trays and wash the trays thoroughly in the same manner as any cooking utensil.
2. Remove the burner caps, bases, the trivets and thoroughly clean including the splash back, interior and exterior surfaces of the range with hot water, a detergent solution and a soft scrubbing brush.
3. Brush the griddle surface (optional - if fitted) with a soft bristled brush. Any carbon deposits should be removed using the optional scraper tool followed by wiping with a cloth to prevent accumulation of food deposits.
4. Clean control panel with a damp cloth lightly moistened with a solution of mild detergent and water. Wipe dry with a clean dry cloth.
5. Dry the Cooktop thoroughly with a dry cloth and polish with a soft dry cloth.

Weekly Cleaning

NOTE:

- **If Cooktop usage is very high, we recommend that weekly cleaning procedure is carried out on a more frequent basis.**
- **Ensure that protective gloves are worn during the cleaning process.**
- **DO NOT use harsh abrasive detergents, strong solvents or caustic detergents as they will damage the cooktop, burners and griddle plate (if fitted).**
- **DO NOT use water on the trivets, griddle plates and burners while they are still hot as cracking may occur. Allow these items castings to cool and remove for cleaning.**
- **DO NOT clean the burners in a dishwasher.**

Cooktop Cooking Area

- a. Clean the Cooktop cooking area using a soft cloth moistened with a mild detergent and hot water solution.
- b. Baked on deposits or discolouration may require a good quality stainless steel cleaner or stainless steel wool. Always apply cleaner when the appliance is cold and rub in the direction of the grain.
- c. It should not be necessary to remove the splash guards covering the burner manifolds for cleaning purposes. These can be cleaned in situ.
- d. Remove the grease / spill tray(s) and clean with a mild anti bacterial detergent and hot water solution using a soft bristled brush. Dry the grease spill tray(s) thoroughly with a dry cloth.

Griddle Plate

CAUTION:

Always ensure that if using a flat scraper tool on the griddle surface, an even pressure is applied over the whole surface of the scraper tool to prevent scoring of the surface.

NEVER bang the sharp edge of the scraper tool on the flat surface of the griddle as this will damage the griddle and invalidate the warranty.

NOTE:

In order to prevent the forming of rust on the griddle plate, ensure that all detergent and cleaning material has been entirely removed after each cleaning process. The appliance should be switched on briefly to ensure the griddle plate becomes dry. Oil or grease should be spread over the griddle surface in order to form a thin protective greasy film.

- a. Remove and clean the grease / spill tray(s) frequently to prevent over spills.
- b. Clean the griddle surface thoroughly with the optional scraper tool or a wire brush. If necessary use a griddle stone or a scotch bright pad on the griddle surface to remove stubborn or accumulated carbon deposits.
- c. A scraper tool can be used for the removal of stubborn carbon and deposits.
- d. Occasionally bleach the griddle plate with vinegar when the plate is cold.
- e. Clean with hot water, a mild detergent solution and a scrubbing brush. Dry all components thoroughly with a dry cloth.
- f. The Cooktop should be switched on briefly to ensure that the griddle plate becomes dry. A thin smear of cooking oil should be spread over the grates in order to form a protective film.

Trivets and Burners

- a. Remove the trivets from the top of the appliance, taking note that the trivets are manufactured with a lip on one edge, the lip must always be fitted to the outer edge (front and back) of the Cooktop.
- b. Remove the burner cap and burner complete with venturi tube, from the top of the cooktop manifold, taking care not to damage the thermocouple (If Fitted - fitted as standard for UK Market) fitted to the mounting rail.
- c. The trivets and burners should be cleaned with a mild detergent and hot water solution using a soft bristled brush. Dry thoroughly with a dry cloth.

Trivet Supports

- a. Remove all the trivet supports from the top of the cooktop. Take note of the orientation of the trivet support when removing. The trivet support front side rail profiles are different from the rear side rail profiles.
- b. The trivet supports should be cleaned with a mild detergent and hot water solution using a soft bristled brush.
- c. Dry the trivet supports thoroughly with a dry cloth.

NOTE:

On units fitted with Flame Failure Thermocouples as standard or as an option, the Mounting Rail is Not removable for cleaning and no attempt should be made to remove this rail.

Stainless Steel Surfaces

- a. With the griddle plates and burners removed, clean the interior and exterior surfaces of the Cooktop with hot water, a mild detergent solution and a soft scrubbing brush. Note that the gas control knobs are a push fit onto the gas control valve spindles and can be removed to allow cleaning of the front of the control panel.
- b. Baked on deposits or discolouration may require a good quality stainless steel cleaner or stainless steel wool. Always apply cleaner when the appliance is cold and rub in the direction of the grain.
- c. It should not be necessary to remove the splash guards covering the burner manifolds for cleaning purposes. These can be cleaned in situ.
- d. Dry all components thoroughly with a dry cloth and polish with a soft dry cloth.
- e. Remove the grease tray and clean with a mild anti bacterial detergent and hot water solution using a soft bristled brush.
- f. Dry the grease tray thoroughly with a dry cloth and polish with a soft dry cloth.

Re-Fitting the Components to the Cooktop

- a. Refit the trivet supports to the Cooktop, ensuring that the trivet supports are correctly fitted.

NOTE:

- It is imperative that the trivet supports are correctly re-fitted to the appliance to ensure that the burners and trivets locate correctly and sit flush and level.
 - Note the orientation of the trivet supports when re-fitting. The trivet support front side rail profiles are different from the rear side rail profiles and will only fit one way to the cooktop.
- b. Refit burners and burner caps onto the cooktop.
 - c. Refit the trivets to the cook top, taking note that the trivets are manufactured with a lip on one edge, the lip must always be fitted to the outer edge (front and back) of the range.
 - d. Refit the spill / grease tray(s) to the range.

Periodic Maintenance

NOTE:

All maintenance operations should only be carried out by a qualified service person.

To achieve the best results, cleaning must be regular and thorough. All controls and mechanical parts should be checked and adjusted periodically by a qualified service person. If any small faults occur, have them attended to promptly. Don't wait until they cause a complete breakdown. It is recommended that the appliance is serviced every 6 months.

Gas Control Valve Re-Greasing

The gas control valve should be dismantled and greased every 6 months to ensure the correct operation of the gas control valve.

To carry out this operation;-

- a. Remove the gas control knobs from the gas tap spindles by pulling the knobs away from the control panel.
- b. Remove the drip tray from the appliance.
- c. Remove 2 screws on the underside of control panel, securing the control panel to the hob.
- d. Remove the control panel from the front of the appliance.
- e. Remove 2 screws holding shaft plate to gas control body and remove control shaft and plate. Note orientation of shaft for correct re-assembly.

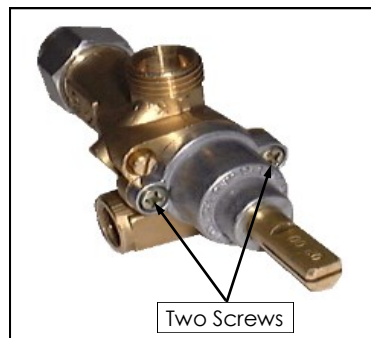

- f. Using needle nose pliers or similar, pull out gas control spindle, again noting its orientation.

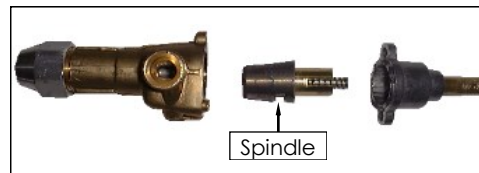

- g. Apply a suitable high temperature gas cock grease or lubricant such as ROCOL - A.S.P (Anti scuffing paste) / Dry Moly Paste to the outside of the spindle.
- h. Replace spindle and re-assemble the gas control in reverse order.
- i. Refit control panel and secure with 2 screws.
- j. Refit the knobs to the gas control valve spindles.

Part 6 Fault Finding

This section provides an easy reference guide to the more common problems that may occur during operation of your equipment. This fault finding guide is intended to help you accurately diagnose and correct problems with your equipment.

Although this section covers the most common problems reported, you may encounter a problem not covered in this section. In such instances, please contact your local authorised service agent who will make every effort to help you identify and resolve the problem. Please note that the service agent will require the following information:-

- **Model Code and Serial Number of appliance. (Both can be found on the Rating Plate located on the appliance).**

Cooktop Open Burners

Fault	Possible Cause	Remedy
Main burners will not light.	No gas supply.	Ensure gas is connected and turned on (bottles not empty).
	Wrong size or blocked injectors.	Call service provider.
	Obstruction in main burner.	Call service provider.
	Incorrect gas supply pressure.	Call service provider.
	Faulty gas control valve.	Call service provider.
Main burners go out when control knob released.	Releasing knob before thermocouple is heated. (FF Burners only).	Hold control knob in for longer (10 secs) after lighting the burner.
	Thermocouple incorrectly positioned.	Call service provider.
	Thermocouple faulty.	Call service provider.
	Gas valve magnet faulty.	Call service provider.
Low fire rate too high.	Incorrect supply pressure.	Call service provider.
	Low fire adjustment incorrect.	Call service provider.
Burner goes out when set to 'Low' position.	Incorrect supply pressure.	Call service provider.
	Low fire rate set too low.	Call service provider.
Main burner flame incorrect colour (yellow / wavy).	Incorrect gas pressure.	Call service provider.
	Incorrect injector size.	Call service provider.
	Obstruction in main burner.	Call service provider.

Part 6 Fault Finding

Griddle Burners

Fault	Possible Cause	Remedy
Pilot burner won't light.	Gas control knob not being held in for long enough.	Hold in button while lighting pilot burner.
	No gas supply.	Ensure gas is connected and turned on (bottles not empty).
	Gas supply pressure too low.	Call service provider.
	Blocked pilot injector.	Call service provider.
	Gas control valve faulty.	Call service provider.
Piezo ignitor not sparking.	Short in high tension lead.	Call service provider.
	Piezo electrode cracked / faulty.	Call service provider.
	Piezo ignitor faulty.	Call service provider.
Pilot flame small / lazy / yellow.	Gas pressure too low.	Call service provider.
	Blocked / incorrect size pilot injector.	Call service provider.
Pilot goes out when knob released.	Releasing knob before the thermocouple is heated.	Hold gas control valve 'In' for longer (10s), see if pilot remains alight.
	Pilot flame too small.	Call service provider.
	Thermocouple faulty.	Call service provider.
	Gas valve magnet faulty.	Call service provider.
Main burners will not light.	Wrong size or blocked injectors.	Call service provider.
	Obstruction in main burner.	Call service provider.
	Incorrect supply pressure.	Call service provider.
	Faulty gas control.	Call service provider.
Main burner flame incorrect colour (yellow / wavy).	Aeration setting incorrect.	Call service provider.
	Incorrect gas supply pressure.	Call service provider.
	Incorrect main burner injector size.	Call service provider.
	Obstruction in burner.	Call service provider.
Pilot goes out when main burner comes 'On'.	Incorrect gas pressure.	Call service provider.
	Faulty gas control valve.	Call service provider.

Gas Conversion Procedure

CAUTION:

Ensure that the unit is isolated from the gas supply before commencing servicing.

NOTE:

- These conversions should only be carried out by qualified persons. All connections must be checked for gas leaks before re-commissioning the appliance.
- Adjustment of components that have adjustments / settings sealed (e.g. paint sealed) can only be adjusted in accordance with the following instructions and shall be re-sealed before re-commissioning this appliance.
- For all relevant gas specifications refer to the table at the end of this section.

Open Burners

1. Turn 'Off' the gas supply at the main supply.
2. Remove pot stands from top of the appliance, taking note that pot stands are manufactured with a lip on one edge, the lip must always be fitted to outer edge (front and back) of the cooktop.
 
3. Remove burner caps and burners (these are a loose fit to the cook top) from top of cooktop, (On Flame Failure units, take care not to damage the thermocouple which is fitted to the mounting bracket / rail. Fitted as standard for UK Market and optional for Non - UK Markets).



4. Unscrew and remove injectors (1/2" A/F) from the gas valves.
5. Determine correct injector sizes for the corresponding gas from the rating plate attached to the underside of the right hand side, front Cooktop lower trim.
6. Replace with the correct size injectors. Refer to the 'Gas Specifications' table at the rear of this section, for correct injector sizes.

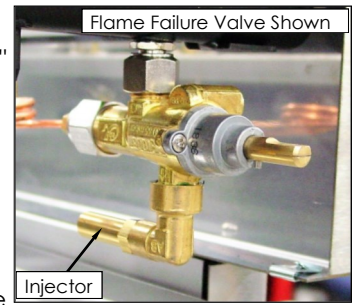

Low Fire Adjustment

- a. To adjust the open burner low fire adjustment, remove the gas control knobs from the front of the control panel.
- b. Adjust the low fire adjustment screw on the open burner gas control valves to obtain the desired flame size.

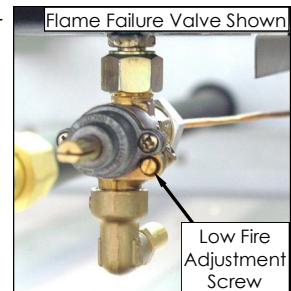

NOTE:

The 'Low Fire Screw' should be sealed with coloured paint on completion of the low fire adjustment.

Aeration Adjustment

- a. Check / adjust the main burner aeration gap. This gap should be set to the dimensions shown in the 'Gas Specifications' tables at the end of this section.

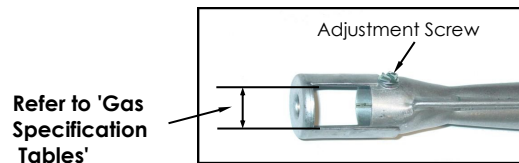

Thermocouple Location

- a. Check the thermocouple is correctly located and that the gap between the thermocouple and the main burner is as shown in the diagram opposite.
- b. Check that the thermocouple connection to the gas valve is tight.

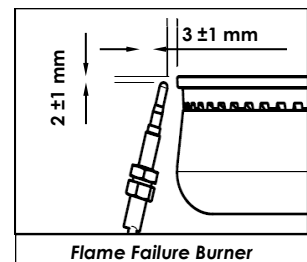

Griddle

Griddle Main Burner

- With the gas supply turned 'Off' at the mains supply, remove the griddle plate section by lifting it straight off the Cooktop.
- Remove the gas control heat shield from around the griddle burner, this is just a push in fit.

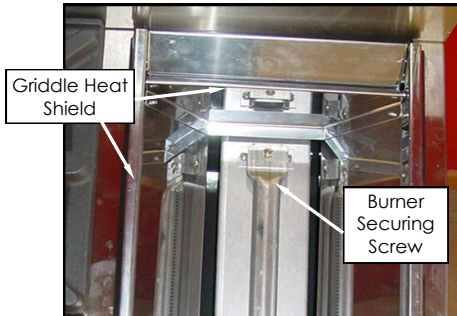

- Disconnect the piezo igniter from the mounting bracket. (For access purposes).

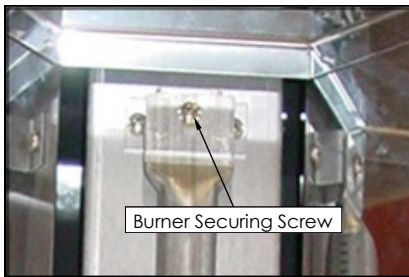

- Remove the main burner from the burner box. Undo the securing screw at the end of the burner, this will reveal the main burner injector.
- Remove and replace the main burner injector with correct size injector. Refer to the 'Gas Specifications' table at the end of this section, for correct injector sizes.

Griddle Burner Aeration Adjustment

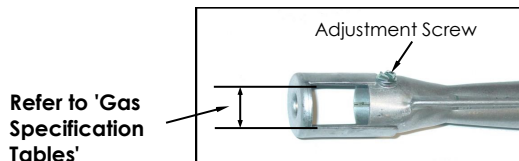

- Check / adjust the griddle main burner aeration gap. This gap should be set to the dimensions shown in the 'Gas Specifications' tables at the end of this section.
- Refit the burner to the griddle burner box.
- Refit gas control heat shield to griddle burner box.
- Refit griddle plate section to top of cooktop.
- Check the thermocouple connection to the gas valve is tight.
- Repeat Items a) to j) for all griddle main burners.
- Turn 'On' the gas supply at the mains, re-light the griddle burners and check the flame size on the 'LOW' flame position.

Griddle Pilot Burner

- Disconnect the pilot supply tube from the pilot burner.
- Remove the existing pilot injector and replace with the correct size for the gas being used. Refer to the 'Gas Specifications' table at the end of this section, for correct injector sizes.



- Re-connect pilot supply tube to pilot burner.
- Refit the piezo igniter to the mounting bracket.
- Repeat Items a) to d) for all pilot burners.

Low Fire Adjustment

- To adjust the griddle burner 'LOW' fire adjustment, remove the griddle gas control knobs from the front of the control panel.
- Adjust the low fire adjustment screw on the griddle gas control valve only, to obtain the desired flame size.



NOTE:

The 'Low Fire Adjustment Screw' should be sealed with coloured paint on completion of the low fire adjustment.

Thermocouple Connection

- Check that the thermocouple connection to the gas valve is tight.

NOTE:

When screwing the thermocouple back into the gas control valve, once threaded up, tighten up another $\frac{1}{4}$ turn only. Do not over tighten.

Gas Regulator

- NAT Gas / LPG Only.

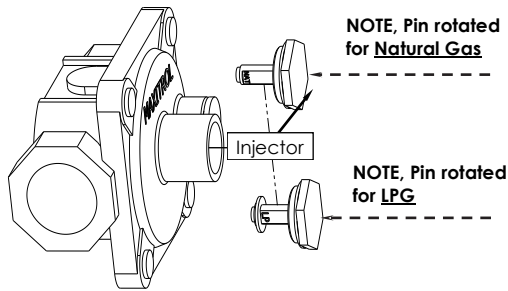

NOTE:

The regulator supplied is convertible between Natural Gas and LP Gas, but its outlet pressure is fixed ex-factory and is NOT to be adjusted.

1. Ensure gas supply is turned 'Off' at the mains.
2. Unscrew hexagonal cap (23 mm A/F) from regulator.
3. Un-clip the plastic pin from the cap, reverse the pin and re-fit it back to cap the correct way for gas type to be used. **(Either 'LP' or 'NAT' should be visible on flank of pin once re-fitted to the cap).**
4. Screw cap back into regulator hand tight only.

Gas Type Identification Label

On completion of the gas conversion, replace the gas type identification label located at:-

- The rear of the appliance, above the gas connection.
- Beside the rating plate.

Commissioning

Before leaving the converted installation;

1. Check all gas connections for leakages using soapy water or other gas detecting equipment.

WARNING

DO NOT USE A NAKED FLAME TO CHECK FOR GAS LEAKAGES.

2. Check the following functions in accordance with the operating instructions specified in the 'Operation' section of this manual.
 - Lighting the Cooktop Open Burners. (Standard / Flame Failure Option).
 - Check Cooktop Low Fire Burner operation.
 - Check Cooktop High Fire Burner operation.
 - Lighting the Griddle Burner (If fitted).
 - Check Griddle Burner operation (If fitted).
3. Ensure any adjustments done to components that have adjustments / settings sealed (e.g. paint sealed), these are re-sealed.



NOTE:

If it is not possible to get the appliance to operate correctly, shut off the gas supply and contact the supplier of this appliance.

Gas Specifications

- United Kingdom

Category: **II_{2H3P}. (20, 37),**
 Flue Type: **A₁.**

		Natural Gas (G20)	Propane (G31)
Open Burner	Burner Injector	Ø 1.90mm	Ø 1.20mm
	Low Fire Setting	¾ turn open c.c.w.	¼ turn open c.c.w.
	Burner Aeration Setting	16mm open.	16mm open.
Griddle	Burner Injector	Ø 2.00mm	Ø 1.25mm
	Low Fire Setting	5/8 turn open c.c.w.	3/8 turn open c.c.w.
	Burner Aeration Setting	Fully open.	Fully open.
	Pilot Injector	0.35	0.23
Supply Pressure		20 mbar	37 mbar
Burner Operating Pressure (*)		10 mbar	28 mbar
Gas Regulator Cap Screw			

NOTE:

- (*) Measure burner operating pressure at manifold test point with two burners operating at 'High Flame' setting.
- NAT, & LPG - Operating pressure is ex-factory set and is not to be adjusted, apart from when converting between gases, if required.
- Refer to the information in this section for further details.

Part 8 Replacement Parts List

Replacement Parts List

IMPORTANT:

Only genuine qualified replacement parts should be used for the servicing and repair of this appliance. The instructions supplied with the parts should be followed when replacing components.

For further information and servicing instructions, contact your nearest qualified service branch (contact details are as shown on the reverse of the front cover of this manual).

When ordering spare parts, please quote the part number and the description as listed below. If the part required is not listed below, request the part by description and quote model number and serial number which is shown on the rating plate.

Open Burners

230014	Pot Stand.		
230088	Pot Stand Support.		
230631	Front Burner Assy.		
230632	Rear Burner Assy.		
230288	Burner Cap.		
230637	Gasket Burner Assy.		
031190	Injector	(Nat. Gas)	Ø 1.90mm.
031120	Injector	(LP Propane)	Ø 1.20mm.
018680	Gas Valve c/w 1/8" Elbow		(Standard Burners Only).
231560	Gas Valve FF c/w 1/8" Elbow		(Flame Failure '-F' Models Only).
230671	Thermocouple - (500mm).		(Flame Failure '-F' Models Only).
242361	Knob - Assy	(Std / F).	

Griddle

014105	Griddle Burner.		
230213	Griddle Reflector Assy.		
227403	Gas Control	(with Flame Failure).	
242362	Knob - Griddle.		
032200	Injector	(Nat. Gas)	Ø 2.00mm.
032125	Injector	(LP Propane)	Ø 1.25mm.
019215K	Pilot Burner (Fully Assembled).		
026488	Pilot Injector	(Nat. Gas)	0.35.
019217	Pilot Injector	(LP Propane)	0.23.
019428	Thermocouple - (320mm).		
227508	Piezo Ignitor.		
228047	Piezo H.T. Lead.		
230289	Grease Tray - (1 per 300mm Griddle Section).		
242330	Griddle Plate 300mm.		
242329	Griddle Plate 600mm.		
242328	Griddle Plate 900mm.		

Part 7 Replacement Parts List

General

242339	Drip Tray C6.
242258	Drip Tray C9.
229674	Rear Roller Assy.
242352	Adjustable Leg - 150mm c/w Leg Plate.

Regulators

Gas Type	Gas Regulator	
	Part No.	Description
Nat. Gas LPG Gas	228531	¾" BSP F/F Convertible.

Gas Conversion Kits

- UK Only

Model	Gas Type to Convert to:	
	Propane	Nat. Gas
C6	242693	242692
C9	242695	242694

