

Envasadoras al vacío
Vacuum packaging machines
Vakuumverpackungsmaschinen
Machines a emballer sous-vide
Machine per il sottovuoto
Embaladoras de vacío

SU

**INSTRUCCIONES - USERS MANUAL - GEBRAUCHSANWEISUNG -
MODE D'EMPLOI - ISTRUZIONI PER L'USO - MANUAL DE INSTRUÇÕES**

Indicaciones para el mercado CE.

Cada máquina lleva los siguientes identificadores:

- Nombre y dirección del fabricante: SAMMIC, S.L. Basarte, 1, Azkoitia Gipuzkoa (SPAIN).
- Marca "CE".
- Se Indica el modelo de máquina en el apartado siguiente.
- El número de serie se indica en la hoja de garantía y en la declaración de conformidad.

MODELOS

Este manual describe la instalación, funcionamiento y mantenimiento de las envasadoras de vacío controlado por sensor:

- Modelos de sobremesa: SU-310, SU-316, SU-416, SU-420, SU-520
- Modelos de suelo : SU-604, SU-606, SU-806, SU-810.
- Modelos de suelo de doble cámara : SU-6000
- Opciones para estos modelos:

-Gas : « G » Sistema de inyección de gas

-Impresora : « P » Placa electrónica con bluetooth para la conectividad con un smartphone permitiendo la creación de etiquetas adhesivas

-Soldadura « + » : Permite seleccionar al usuario mediante una pulsación disponer de mayor potencia de soldadura para las bolsas metálicas

La referencia del modelo y sus características se indican en la placa de identificación colocada en la máquina.

Estas envasadoras están diseñadas y fabricadas de acuerdo con las directivas Europeas 89 / 392 / CEE, 93 / 68 CEE, 73 / 23 / CEE y a la normativa NSF de higiene y sanidad.

INSTALACION

Para conseguir las mejores prestaciones, así como una buena conservación de la máquina, hay que seguir cuidadosamente las instrucciones contenidas en este manual.

Emplazamiento

Colocar la máquina de tal manera que quede debidamente nivelada. Para evitar daños, la máquina no debe apoyarse nunca sobre uno de sus lados.

Las máquinas de sobremesa deben instalarse sobre una superficie lisa, ya que las patas están fabricadas en material deslizante para poder mover la máquina sin esfuerzo y limpiar la superficie sobre la que se apoya.

Conexión Eléctrica

1. Características de la máquina

-Las máquinas monofásicas se suministran para tensión de 230V.

-Las máquinas trifásicas se suministran para tensiones de 230V ó 400V (conectadas a 400V).

Antes de conectar la envasadora a la red, comprobar la máquina está preparada para el mismo voltaje que el de la red.

Para el cambio de voltaje (solo maquinas trifásicas):

1. Conectar los transformadores a la tensión adecuada, según se indica en su regleta de conexiones.
2. Cambiar si es necesario las conexiones en el motor según se indica en su caja de bornes.
3. Ajustar, si es necesario, el relé térmico según se indica en el esquema eléctrico.

2. Características del cable

Las envasadoras SAMMIC se suministran con un cable eléctrico de 1,5 m de largo, con recubrimiento termo plástico.

ES OBLIGATORIA LA CONEXION CON TIERRA. El hilo de toma-tierra de la máquina está señalizado. Además la maquina está provista de un tornillo externo para la conexión a un sistema equipotencial de tierra.



- Máquinas trifásicas: Preparar una toma de corriente mural con protección magneto-térmica y diferencial de 3P+N+T de 20 A, y una clavija estanca para conectarla al cable de alimentación de la envasadora.

- Máquinas monofásicas: Preparar una toma de corriente mural con protección magneto-térmica y diferencial de 2P+T de 20 A. La clavija que forma parte del cable de alimentación debe ser accesible.

3. Cambio sentido giro bomba de vacío (únicamente en máquinas trifásicas)

Si al arrancar la máquina se produce un ruido anormal en el motor de la bomba de vacío, es debido a que está girando en sentido inverso. En tal caso, parar inmediatamente la máquina e intercambiar dos hilos en la alimentación.

Llenado de aceite

En los modelos SU-416, SU-420, SU-520, SU-600, SU-800 la bomba ya contiene aceite.

En los modelos SU-310, SU-316 llenar de aceite la bomba a través de la toma, hasta completar ¾ partes de la mirilla. Se debe emplear aceite sin detergentes:

-Aceite SAE10 (sin detergente) para las bombas hasta 20 m³/h.

-Aceite SAE30 (sin detergente) para las bombas

superiores a 20m³/h.

Se recomienda que los aceites empleados sean parafínicos.

PUESTA EN MARCHA

Una vez accionado el interruptor general, al objeto de que el aceite se caliente y permita un vacío correcto, es necesario realizar varios ciclos en vacío antes de proceder al primer envasado.



TECLA ON/OFF:  Dispone de 2 pilotos:

- Rojo en espera con la máquina conectada a la red. La máquina está apagada en "OFF".
- Cuando se pulsa pasa a azul: máquina encendida "ON".



Si durante un tiempo no se utiliza la máquina, entonces pasa automáticamente a espera OFF.

FUNCIONAMIENTO:



TECLA:  Con cada pulsación se accede a:

-  PROGRAMAS de vacío del 1 a 25: Parpadea el número de programa al que se

accede mediante las teclas  

-  **VACIO POR ETAPAS:** Para productos porosos, carnes procesadas, mezclas emulsionadas con aire atrapado, etc. Se realizan 3 etapas hasta llegar al vacío consigna con un tiempo de espera fijo en cada etapa:

Ej.: si el valor consigna es 99%:

- Etapa 1: 91%, t = 10s
- Etapa 2: 95%, t = 10s
- Etapa 3: 97%, t = 10s
- Final: 99%



VACIO EXTERIOR (VAC. NORM):



Para cubetas Gastronorm especiales para vacío. Para poder utilizar esta función es necesario adquirir el kit VAC-NORM, que incorpora la manguera y la adaptación a la cuba de la envasadora.

- Antes de activar la función VAC-NORM, colocar el adaptador y la manguera en la aspiración de la máquina.
- Colocar el otro extremo de la manguera en la cubeta.



· Cuando se pulsa la tecla  arranca la bomba que funciona hasta que el vacío alcanzado sea el de consigna, entonces se detiene y activa la descompresión para



liberar el tubo. Si se pulsa  durante el vacío la bomba hace una pausa y se ilumina 

· **DRY OIL**, Secado de aceite: Permite mantener el aceite en buenas condiciones reduciendo la humedad contenida que permite alcanzar el máximo vacío de la bomba. Se baja la tapa y la bomba funciona en continuo durante 15min. Cada 2min se activa la válvula de entrada de aire, sin detener la bomba. En el display central se muestra el tiempo en minutos que queda para el final del ciclo.



· Pulsando  también finaliza el proceso en cualquiera de los modos de funcionamiento antes indicados. Se detiene la fase del programa que se está ejecutando y pasa a la siguiente.

PROGRAMAS DE VACIO:



· Se pulsa  y se pulsa 



o  para seleccionar el número de programa de **1 a 25**

· Sucesivamente se pulsán las teclas del ciclo



y se pulsa  o  para elegir los valores



· **VACIO**: se selecciona el porcentaje de vacío: 1% a 99%



· **VACIO +**: 1s – 15s funciona solo si se ha seleccionado el vacío 99%



· **GAS**: muestra la cantidad de gas que se introduce en %.

· Ej: al seleccionar **20%** de Gas y 99% de Vacío el display visualizará en el ciclo la presión final de vacío 99% y después introduce el 20% de gas mostrando en el display: 99% –

20% = 79%.

· Si la consigna es 0% entonces **NO** se introduce gas.



· **SOLDADURA**: tiempo de sellado de la bolsa: 0 – 7s



· **SOLDADURA +**: Si la máquina está provista con este sistema (ver ajustes iniciales) para activarla basta con mantener pulsada la



tecla  hasta que se active el icono. **Se aumenta la potencia de sellado** para bolsas de tipo metálico.



· **ATMOSFERA PROGRESIVA**: entrada de aire suave a la cámara de 0 – 9s





· Se pulsa  o se baja la tapa para efectuar el ciclo que también quedará memorizado.

· Bajando la tapa arranca el ciclo.

· **PAUSA VACÍO**: Durante la fase de vacío



si se pulsa la tecla  la bomba se detiene y se indica en el display el símbolo  manteniendo el vacío. Pulsando nuevamente arranca la bomba continuando el proceso de vacío.

· Si el bloqueo  queda activado entonces **NO** se permitirá modificar los valores del programa de envasado.

· Para desbloquear un programa se pulsa



y Pulsando **OK** parpadea  y



pulsando  o  se selecciona



ON/OFF. Para salir se pulsa 

PROCESO DE ENCENDIDO y AJUSTES INICIALES:



En los 3 primeros segundos se visualiza el número de modelo en el display central. También se enciende el símbolo  y en el display de 11 caracteres se ve el número de horas de funcionamiento de la bomba, para el control del cambio de aceite.

Ajustes posibles dentro de los 3 primeros segundos:



· **Número de modelo**: Pulsando  mantenido durante 2s. Se ajusta el número de



modelo entonces pulsar  o  hasta mostrar el número de modelo:

Modelos equipados CON sistema de inyección de Gas:

· N° "0": Máquinas de suelo, funcionamiento continuo: SU-600, SU-800, SU-6000. La bomba está en marcha desde el momento que se acciona el interruptor general. Esta configuración está pensada para las máquinas que están instaladas en lugares fríos o cámaras frigoríficas.

· N° "1": Máquinas de suelo, funcionamiento intermitente: SU-600, SU-800, SU-6000. La bomba está en marcha durante la fase de vacío y soldadura.

· N° "2": Máquinas de sobremesa, funcionamiento intermitente: SU-300, SU-400, SU-500. La bomba está en marcha solo en la fase de vacío.

Modelos SIN sistema de inyección de Gas: Con el mismo modo de funcionamiento de la bomba que los anteriores se configuran los mismos modelos pero sin Gas.

· N° "3":

· N° "4":

· N° "5":

· **SOLDADURA + (Opcional)**: Si la máquina está equipada con este sistema, para cada número de modelo elegido pulsando la tecla



se activa el símbolo 



· **Idioma y fecha**: Pulsando  mantenido durante 2s Se ajusta el idioma, fecha, hora, y temperatura:

1. IDIOMA



· Pulsando  Parpadea "Español" pulsar



o  hasta elegir: "English", "Francais", "Deutsch", "Italiano",



"Português" pulsar 

2. FECHA (Solo modelos con placa bluetooth-impresora)

· Muestra fecha: dd/mm/aaaa

· Parpadea dd pulsar  o  y se detiene el parpadeo y pasa a:

· mm pulsar  o  y 

· aaaa pulsar  o  y 

3. HORA



· xx H  o  y 

· xx MIN  o  y 

· **Horas Bomba:** Pulsando  en los 3 primeros seg. Se hace un reset de las horas de funcionamiento de la bomba.

· **Prueba pantalla LCD:** Pulsando  en los 3 primeros seg. Se hace una prueba de la pantalla LCD para comprobar los segmentos de la pantalla: se iluminan TODOS los símbolos durante 2s.

· **Nº Bluetooth (modelos opción impresora):**

Pulsando  en los 3 primeros seg. se mostrará el icono  activado y en el display alfanumérico un número de 4 dígitos: "SU XXXX". Ese número debe coincidir con el número mostrado en la aplicación (APP) del móvil.

· **Versión programa:** Pulsando  en los 3 primeros seg. se muestra en el display alfanumérico el número de versión del programa que utiliza la placa electrónica.

Finalizado cada ajuste se pulsa  para apagar la máquina, y se enciende nuevamente para acceder a otros ajustes o al funcionamiento normal.

CREACION E IMPRESIÓN DE ETIQUETAS:

· En la aplicación desarrollada para móvil-tableta el usuario escribe una lista de hasta 50 productos donde puede escribir:

- **Nombre del establecimiento:** "30 caracteres"
- **Producto:** "40 caracteres"
- **Fecha de Envasado:** Ej. "10/11/2016" (Automático según la fecha de la máquina)

· **Vacío:** Ej. "99%" Gas: Ej. "20%" (Automático según el valor de vacío y gas realizado por la máquina)

· **Temperatura Conservación:** en °C, °F según los ajustes en la aplicación para impresión de etiquetas (APP)

· **Consumir antes de:** se introducen los días de caducidad y en la etiqueta aparece la fecha de caducidad calculada a partir de la fecha de envasado

· El producto "0" se visualiza en el display como "ETIQUETA MANUAL" y solo permite la impresión de la etiqueta con los valores automáticos de "Fecha Envasado" y "VACIO" el resto quedan libres para escribir manualmente sobre la etiqueta.

DESCRIPCION APP PARA SMARTPHONE – TABLETA

Se carga la aplicación en un teléfono móvil o tableta:

- Sistema Android: "Play Store"
- Sistema iPhone: "Apple Store"

1. Abrir la aplicación SAMMIC VACUUM 

TECLA: "IMPRESIÓN DE ETIQUETAS" (Solo modelos equipados con placa bluetooth)

Al pulsar la tecla  se accede al menú de la impresión de etiquetas. Pulsando



sucesivamente  se accede a:

·  LISTA DE PRODUCTOS pulsando

 o  se visualiza en el display el nombre del producto, número de producto y el programa asociado.

·  IMPRESORA CONECTADA: se enciende automáticamente cuando se conecta la impresora.

·  DIAS DE CADUCIDAD: pulsando

 o  se selecciona la caducidad en número de días. En la etiqueta se mostrará la fecha de caducidad resultante.

·  TEMPERATURA CONSERVACION:

pulsando  o  se selecciona

la temperatura necesaria para garantizar la conservación del producto.

·  NUMERO DE ETIQUETAS: pulsando

 o  se selecciona el número de etiquetas que se imprimirán en cada ciclo.

·  BLOQUEO DEL PROGRAMA: pulsando

 o  se selecciona ON/OFF.

Si está activado se bloquean las teclas de programación del ciclo de vacío, con objeto de garantizar que no se cambien los parámetros de envasado.

· Para salir, pulsar nuevamente 

IMPRESIÓN DE ETIQUETAS:

· Colocar el rollo de etiquetas siguiendo las instrucciones contenidas en el manual de la impresora

· Conectar la impresora con el cable suministrado.



· Encender la impresora: Pulsar "POWER", el piloto "ON LINE" se ilumina en rojo, luego en

verde. Se activa  Durante el ciclo de envasado cuando llega la fase de soldadura se imprime la etiqueta.

· Si se desea imprimir más de una etiqueta durante el ciclo:

Pulsando la tecla  se accede al menú de la impresión de etiquetas. Pulsando

sucesivamente  se accede a:

a.  NUMERO DE ETIQUETAS: pulsando



o se selecciona el número de etiquetas que se imprimirán en cada ciclo.

- **Etiqueta extra:** Finalizado un ciclo pulsando



una vez abierta la tapa antes de 10s sin efectuar otro ciclo, se imprime una nueva etiqueta.

- **Apagado de la impresora:** Pulsar y mantener el botón "POWER" hasta que el indicador "ON LINE" pasa a rojo y luego se apaga



IMPRESIÓN DE ETIQUETAS: VAC-NORM

Después de haber arrancado el vacío, con la impresora activada, cuando se ha alcanzado el valor de vacío de consigna se detiene la bomba y se imprime 1 etiqueta indicando el vacío máximo que se alcanzó.

CORTE DE BOLSA

Las barras que incluyen el hilo para el corte de bolsa se suministran como kits.

La instalación se efectúa cambiando la barra de soldadura por la barra que contiene el hilo de corte y cambiando la conexión de uno de los cables en el transformador de soldadura a la tensión que se indica en el esquema eléctrico: Para realizar el corte de la bolsa, basta con programar el tiempo adecuado de soldadura en la placa de control y una vez soldada la bolsa se rasga manualmente por la línea marcada por el hilo de corte.

UTILIZACIÓN Y MANTENIMIENTO

- Muy importante: No envasar productos en caliente, ya que el vapor que producen, daña la bomba de vacío.

- **NUNCA** envasar productos empleando gas con un contenido en oxígeno mayor del **20%** sin antes consultar a su proveedor o servicio reconocido por SAMMIC. **Esto podría causar explosiones fatales.**

Envasado de líquidos:

Todos los modelos "SU" están provistos de un sistema para la detección de la evaporación de un líquido que se está envasando. Cuando se produce la evaporación de un líquido la presión de vacío deja de disminuir y si esto ocurre el control electrónico detiene el proceso de vacío y se ilumina el símbolo . Esto se hace para evitar que el líquido contamine la cámara de vacío y el aceite de la bomba.

El símbolo  Permanece iluminado hasta que comienza un nuevo ciclo.

Nota: Determinadas mezclas con apariencia de líquido pero batidas con un mixer, contienen aire atrapado en la mezcla. En esas situaciones es posible que el detector no funcione óptimamente y entonces es necesario pulsar la



tecla para hacer PAUSA o



para evitar que el líquido pueda estropear el aceite.

Para el envasado de líquidos se debe emplear el accesorio que mantiene la bolsa con una inclinación para evitar la salida del líquido. Si aparecen burbujas durante el envasado entonces se ha alcanzado el punto de saturación. El punto de saturación es similar al punto de evaporación-ebullición que se produce a distintas temperaturas en función de la presión.

El punto de saturación se alcanza antes cuanto más alta es la temperatura del líquido durante el proceso de vacío. Se recomienda primeramente enfriar el líquido antes de envasarlo para obtener el óptimo vacío del producto.

Se indica una tabla del punto de saturación del agua con la relación entre la temperatura y la presión. Esto indica aproximadamente el MAXIMO VACIO que se puede hacer para cada temperatura indicada del producto.

Presión vacío (mbar)	1000	100	50	31,67	20	10	6,09	5	2
Presión vacío (%)	0	90,1	95	96,87	98	99	99,4	99,5	99,8
Temp. Evaporación (°C)	100	45	33	25	18	7	0	-2	-13

Secado del aceite:

Después de trabajar con líquidos es conveniente al final de cada jornada hacer un ciclo de secado del aceite que elimina la humedad contenida en la bomba y mantiene su capacidad para hacer el máximo vacío. Para ello seleccionar el programa  según se indica en el apartado "FUNCIONAMIENTO"

Parada automática de la bomba:

En los modelos con funcionamiento continuo de la bomba si la máquina NO se utiliza durante 10min la bomba se detiene automáticamente.

Esto impide un sobrecalentamiento del aceite, y reduce la cantidad de aceite depositada en los filtros de expulsión, además de ahorrar energía. Cerrando la tapa, la bomba y el ciclo arrancan simultáneamente.

-Es importante limpiar cada día el interior y bordes de la cámara, así como la junta del cierre.

-El exterior de la máquina no se debe limpiar con un chorro directo de agua. Emplear para su limpieza un paño húmedo y cualquier detergente habitual. Nunca limpiar la tapa con alcohol, disolventes o productos limpiacristales puesto que puede afectar a las propiedades mecánicas del material y provocar su rotura. En caso de observar una fisura en la tapa, no continuar trabajando con la máquina y avisar al servicio técnico autorizado para su reparación, hay riesgo de rotura de la tapa.

-Si el cable de alimentación se deteriora y es preciso instalar uno nuevo, dicho recambio sólo podrá ser realizado por un servicio técnico reconocido por SAMMIC.

-Antes de cualquier intervención para la limpieza, revisión o reparación de la máquina, es obligatorio desconectar la máquina de la red.

-El nivel de ruido de la máquina, en marcha colocada a 1.6 m de altura y 1 m de distancia es 75 dB (A). Ruido de fondo: 32 dB (A).

Cambio de aceite

Es necesario controlar semanalmente el nivel de aceite, que debe cubrir 3/4 de la mirilla. Completarlo si es preciso.

El aceite debe ser cambiado tras las primeras 100 horas de funcionamiento. Posteriormente cambiar el aceite:

- Modelos de sobremesa; Número de modelo 2: 150horas
- Modelos de suelo; Bomba funcionamiento intermitente, Número de modelo 1: 300horas
- Modelos de suelo; Bomba funcionamiento continuo, Número de modelo 0: 300horas
- Cuando la bomba haya trabajado las horas indicadas, al encender la máquina el visor indicará las horas, y el símbolo  se enciende para avisar del cambio necesario del aceite.
- También se debe cambiar el aceite si se observa que está emulsionado. La cantidad de horas de trabajo acumuladas se puede

visualizar al encender la máquina. Para efectuar el cambio, soltar el tapón de vaciado y dejar que salga el aceite usado. Para el llenado seguir las instrucciones dadas en el apartado correspondiente.

- En las bombas de 40m³/h y superiores, simultáneamente se debe cambiar el filtro de aceite. Este filtro es del tipo empleado en el automóvil según referencia: AWS2, rosca 3/4.
- El filtro de escape se debe sustituir cada 4 cambios de aceite o cuando se observen pérdidas de aceite o bien niebla de aceite en el escape.

OBSERVACIONES

Estando la maquina en el ciclo de vacío si el sensor detecta que la presión de vacío no llega a la consigna programada, tras un tiempo de espera, se detiene el ciclo pasando a descompresión.

Si al hacer la descompresión la tapa no se abre, después de un tiempo la electroválvula de descompresión se desconecta para evitar daños en la misma o en la placa electrónica.

Otras indicaciones importantes:

- Aparato destinado para uso industrial.
- ATENCIÓN: Desconectar la alimentación eléctrica antes del mantenimiento.
- Este aparato no está destinado para ser usado por personas (incluidos niños) cuyas capacidades físicas, sensoriales o mentales estén reducidas, o carezcan de experiencia o conocimiento, salvo si han tenido supervisión o instrucciones relativas al uso del aparato por una persona responsable de su seguridad.
- Los niños deberían ser supervisados para asegurar que no juegan con el aparato.
- Limpieza de la TAPA:

¡Precaución!

Nunca limpiar la tapa con alcohol, disolventes o productos limpiacristales puesto que puede afectar a las propiedades mecánicas del material y provocar su rotura. Para su limpieza emplear agua y jabón. En caso de observar una fisura en la tapa, no continuar trabajando con la máquina y avisar al servicio técnico autorizado para su reparación, hay riesgo de rotura de la tapa.

- Aceite de la Bomba

Atención: La bomba de vacío contiene aceite, no inclinar la máquina

NOCIONES BÁSICAS SOBRE EL ENVASADO AL VACÍO

El vacío es un sistema de conservación natural que consiste en la extracción del aire del interior de la bolsa eliminando el oxígeno, principal factor del deterioro de los alimentos.

Ventajas del envasado al vacío

- 1-Reduce al máximo las mermas de los productos.
- 2-Rentabiliza al máximo las horas de personal al aprovechar los tiempos muertos que se pueden dar a lo largo de la semana para adelantar trabajo y aligerar el flujo de trabajo de las cocinas.
- 3-Racionaliza el almacenamiento de los productos en las cámaras:
 - No hay mezcla de olores.
 - Los productos se presentan etiquetados, lo que permite una rotación de materias primas.
 - Mejora el control de stock ya que se puede calcular con precisión las compras necesarias para cada momento.
- 4-Aprovechamiento de los mejores días de compra:
 - Permite comprar cuando los precios son mejores.
 - Reducción de desplazamientos.
- 5-Reduce el lavado de utensilios.

Envasado productos curados (embutidos, jamones, etc)

Siendo de por sí productos de una vida prolongada el envasado al vacío duplica, como mínimo, la vida de estos productos evitando que se resequen y que pierdan peso con el consiguiente perjuicio económico. Estos productos no es necesario envasarlos con gas, salvo algunos productos de textura frágil.

Envasado de productos cocinados

Este es el caso de productos como los asados, estofados, canelones, etc. Una vez cocinados es indispensable enfriar dichos alimentos de +65°C a +10°C en menos de dos horas en el corazón del producto para impedir desarrollo de microorganismos.

Este es el método más práctico para mantener la cocina tradicional con las siguientes ventajas:

- Facilitar el trabajo en las preparaciones sin necesidad de correr riesgos de pérdida del

producto.

- Alargar la vida del producto.

Cocción de productos envasados

Consiste en colocar un alimento dentro de un envase que sea estanco y termoresistente. Extraer el aire de su interior, sellarlo y someterlo a la acción de una fuente de calor para cocerlo. La cocción se realiza a baja temperatura (entre 65°C y 100°C) consiguiendo un efecto de pasteurización. Este sistema tiene muchas ventajas como son:

- Preserva las cualidades nutricionales.
- Preserva las condiciones higiénicas al reducirse la manipulación.
- Reduce las pérdidas de peso en la cocción, al evitar la evaporación y la desecación.
- Racionaliza la planificación del trabajo. Preparación y cocción fuera del período de servicio, anticipación de la preparación de banquetes, etc.
- Prolonga el tiempo de conservación.

Posteriormente a la cocción el producto, este debe ser enfriado rápidamente para detener el proceso de cocción e impedir el desarrollo de microorganismos. Este proceso se lleva a cabo mediante un abatidor de temperatura.

Platos refrigerados: Se debe rebajar la temperatura de +65°C a +10°C en menos de 2 horas en el corazón del producto.

Platos congelados: Se debe rebajar la temperatura de +65°C a -18°C en menos de 4,5 horas en el corazón del producto.

El posterior almacenamiento debe mantener una temperatura 0°C a 3°C para los platos refrigerados y de -18°C para los platos congelados.

Para poder poner los alimentos en condiciones de degustarlo, el proceso de regeneración se debe realizar de forma inmediata una vez fuera del refrigerador en el que ha sido almacenado. Básicamente, son tres las técnicas de regeneración: el horno a vapor a baja presión, el baño maría y el horno microondas. En los dos primeros casos, la regeneración se lleva a cabo con el material dentro del propio envase, mientras que en el caso del microondas, es necesario perforar la bolsa para que el vapor pueda escapar sin que explote el envase o bien regenerar el producto fuera del mismo.

Si un producto regenerado no llega a consumirse, no puede volver a almacenarse y

hay que deshacerse del mismo.

El tiempo de almacenamiento de los platos refrigerados no debe exceder 6-21 días.

Congelación de productos envasados al vacío

Las técnicas de congelación tradicionales conservan el producto pero no así su calidad. La congelación de productos envasados al vacío tiene muchas ventajas:

- No hay quemado exterior
- No hay cristalización superficial
- No hay pérdida de gusto y aroma
- No hay desecación
- No hay oxidación de grasas

Indications for CE marking.

Each machine has the following identification elements:

- Name and address of the manufacturer: SAMMIC, S.L. Basarte, 1, Azkoitia Gipuzkoa (SPAIN).
- “CE” mark.
- The machine model is shown in the next section.
- The serial number is printed on the Guarantee Card and in the Declaration of Conformity.

MODELS

This manual describes the installation, operation and maintenance of the sensor controlled vacuum packing machines:

- bench top models: SU-310, SU-316, SU-416, SU-420, SU-520
- free-standing models: SU-604, SU-606, SU-806, SU-810.
- Free-standing, double-chamber models: SU-6000
- Options for these models:
 - Gas : « G » Gas injection system
 - Printer: « P » Electronic board with Bluetooth for connectivity with a smartphone to print adhesive labels
 - Sealing « + » : Select the user at the press of a button, more sealing power available for metal bags

The model reference and its specifications appear on the name plate attached to the machine.

These packaging machines are designed and manufactured in accordance with European directives 89 / 392 / EEC, 93 / 68 EEC, 73 / 23 / EEC and the NSF health and hygiene standard.

INSTALLATION

For optimum performance and long service life of the machine, carefully read and follow the instructions provided in this manual.

Placement

Place the machine so that it is correctly levelled. To prevent damage, the machine must never rest on one side.

Bench top machines must be installed on a smooth surface, since their legs are made of a sliding material for easy removal of the machine to clean the supporting surface.

Electrical connection

1. Machine specifications

-A single-phase motor is supplied for operation on 230V.

-A three-phase motor is supplied for operation on 230V or 400V (factory-set to 400V).

Before connecting the vacuum packing machine to the mains, check whether the machine is prepared for the same voltage as the mains.

To change the voltage setting (only three-phase machines):

1. Connect the transformers to the corresponding voltage as indicated on their connection board.
2. If necessary, change if the connections in the motor as indicated in the terminal box.
3. If necessary, adjust the thermal relay as indicated on the wiring diagram.

2. Power cable specifications

SAMMIC packaging machines are supplied with an electric cable 1.5 m long, with plastic thermal covering.

THE EARTH CONNECTION IS OBLIGATORY.

The machine's earth connection wire is indicated. The machine is also fitted with an external screw for the connection to an equipotential earth connection system



- Three-phase machines: Prepare a wall-mounted mains socket with 3P+N+E, 20 A magneto-thermal and differential protection, and a sealed plug to connect it to the power supply cord of the packing machine.

- Single-phase machines: Prepare a wall-mounted mains socket with 2P+E, 20 A magneto-thermal and differential protection. The plug, which forms part of the power supply cable, must be accessible.

3. Changing the vacuum pump turning direction (only in three-phase machines)

If an abnormal noise occurs in the vacuum pump motor when starting the machine, it is because it is rotating in reverse. In this case, stop the machine immediately and exchange two phases in the power supply.

Oil filling

In models SU-416, SU-420, SU-520, SU-600, SU-800, the pump already contains oil.

In models SU-310, SU-316, fill the pump with oil through the inlet, until it reaches $\frac{3}{4}$ of the indicator. Detergent-free oil must be used:

-SAE10 Oil (without detergent) for pumps up to 20 m³/h.

-Oil SAE30 (without detergent) for pumps over 20 m³/h.

It is recommended that the oils used are paraffin.

START-UP

Once the main switch has been turned on, several cycles must be run empty prior to the first packaging so that the oil is hot and the correct vacuum is obtained.



ON/OFF BUTTON: Includes two lights:

- Red on standby with the machine connected to the network. The machine is switched off in “OFF”.
- When pressed it changes to blue: machine turned “ON”.

If the machine is not used for a period of time, it will then automatically standby in OFF mode.

OPERATION:



KEY: The following functions are accessed with each press:

- **PBB** Vacuum PROGRAMS 1 to 25: The number of the program accessed with the



keys will flash

- **VAC** VACUUM BY STAGES: For porous products, processed meats, emulsified mixtures with trapped air, etc. Perform these three steps to reach the vacuum setpoint with a fixed waiting time in each stage:

E.g. .: if the setpoint is 99%:

- Stage 1: 91%, t = 10s
- Stage 2: 95%, t = 10s
- Stage 3: 97%, t = 10s
- End: 99%



EXTERIOR VACUUM (VAC. NORM): For special Gastronorm trays for vacuum. In order to use this function, you need to purchase the VAC-NORM kit that includes a hose and connector to the chamber of the vacuum packing machine.



- Before activating the VAC-NORM function, place the connector and hose in the machine suction.
- Place the other end of the hose in the tray.



- When the **OK** key is pressed the pump starts, which operates until the vacuum reaches the setpoint; it will then stop and

activate the decompression to release the



tube. If  is pressed during vacuum, the pump will pause and  will light up

- **DRY OIL**: Oil drying: Allows you to keep the oil in a good condition, reducing the moisture retained and enabling the pump to reach maximum vacuum. The cap lowers and the pump operates continuously for 15 minutes. Every two minutes the air intake valve is activated, without stopping the pump. The central display will indicate the amount of time in minutes remaining until the end of the cycle.



- Pressing  also ends the process in any of the operating modes listed above. Stops the programme phase that is currently running and moves on to the next.

VACUUM PROGRAMMES:



- Press  and press  or



 to select the program number from 1 to 25

- Successively press the cycle keys or press



or  to select the values.



- **VACUUM**: choose the vacuum percentage: 1% to 99%



- **VACUUM +**: 1s - 15s; only works if 99% vacuum is selected



- **GAS**: shows the quantity of gas filled in %.

• E.g. to select 20% gas and 99% vacuum, the display will show the final vacuum pressure 99% in the cycle and after filling 20% gas, the following will show on the display: 99% – 20% = 79%.

- If the setpoint is 0% **NO** gas must be filled.



- **SEALING**: bag sealing time: 0 – 7s



- **SEALING +**: If the machine is equipped with this system (see initial settings),



to activate it just press and hold the  button until the icon is activated. Increase the sealing power for metal bags.





- **PROGRESSIVE ATMOSPHERE**: gentle air entry into the chamber 0 - 9s



- Press  or lower the lid to execute the cycle, which is also memorised.
- Lowering the lid starts the cycle.



- **VACUUM PAUSE**: If the  key is pressed during the vacuum phase, the pump stops, indicated as such by the symbol  on the display, with the vacuum remaining active. Press the key once more to start the pump and continue the vacuum process.

- If the lock  is activated, the packaging program values **CANNOT** be changed.



- To unlock a program press  and



pressing **OK**  flashes. Press  or



 to select **ON/OFF**. To exit, press

PROCESS OF SWITCHING ON AND INITIAL ADJUSTMENTS:

In the first three seconds the model number is displayed on the central display. The  symbol also illuminates and the number of hours of the pump's operation will appear in the 11-character display, for controlling the oil change.

Possible adjustments within the first 3 seconds:



- **Model number**: Press and hold  for 2s. Adjust the model number by pressing



or  until the model number appears:

Model equipped WITH the gas injection system:

- **No. "0"**: Free-standing machines, continuous operation: SU-600, SU-800, SU-6000. The pump starts operating from the moment the main switch is pressed. This configuration is intended for machines installed in cold rooms or refrigerated chambers.

- **No. "1"**: Free-standing machines, intermittent operation: SU-600, SU-800, SU-6000. The pump is in operation during the vacuuming and sealing stage.

- **No. "2"**: Bench top machines, intermittent operation: SU-300, SU-400, SU-500. The pump is only in operation during the vacuuming stage.

Model WITHOUT gas injection systems: The same models are configured with the same pump operation mode as the previous ones, but without gas.

- **No. "3"**:

- **No. "4"**:

- **No. "5"**:

- **SEALING + (optional)**: If the machine is equipped with this system, for each model



number chosen by pressing the  key,



the  symbol will be activated.

- **Language and date**: Press and hold



 for 2 seconds to adjust the language, date, time, and temperature:

1. LANGUAGE



-  "Español" will flash, press



-  or  to select: "English", "Français", "Deutsch", "Italiano", "Português"



press 

2. DATE (only models with bluetooth-printer plate)

- Example date: **dd/mm/yyyy**



- When **dd** flashes press  or 

and  the flashing will stop and it will change to:

· mm press  or  and



· yyyy press  or  and



3. TIME



· xx H  or  and 

· xx MIN  or  and 

• **Pump hours:** Press  in the first three seconds. Resets the pump's operating hours.

• **LCD screen test:** Press  in the first 3 sec. Tests the LCD screen is made to check the segments of the display: ALL symbols light up for 2s.

• **Bluetooth No. (printer option models):**

Press  in the first 3 sec. to activate the  icon and a four digit number in the alphanumeric display: "SU XXXX". This number must match the number shown in the mobile application (APP).

• **Programme version:** Press  in the first 3 sec. to display the version number in the alphanumeric display of the program that the electronic board uses.

At the end of each adjustment press  to switch the machine off, and switch it on again to access other settings or normal operation.

CREATE AND PRINT LABELS:

- In the application developed for mobile/tablet, the user has a list of up to 50 products in which the following can be written:
 - **Establishment name:** "30 characters"
 - **Product:** "40 characters"
 - **Packaging date:** E.g. "10/11/2016" (Automatic according to the date of the machine)
 - **Vacuum:** E.g. "99%" Gas: E.g. "20%" (Automatic according to the vacuum and gas value by the machine)
 - **Temperature conservation:** in °C, °F according to the settings in the application for label printing (APP)
 - **Best before date:** enter the days to expiry and the expiry date calculated from the packaging date will be calculated.

- The product "0" is displayed on the display as "MANUAL LABEL" and only allows label printing with the automatic values "Packaging Date" and "BLANK". The rest are free for manually writing on the label.

SMARTPHONE/TABLET APP DESCRIPTION

Load the application on a mobile phone or tablet:

- Android System: "Play Store"
 - iPhone system: "Apple Store"
1. Open the SAMMIC VACUUM application



KEY: "LABEL PRINTING" (only models equipped with Bluetooth board)

Press the key  to access the label printing menu. Successively press

 to access:

-  PRODUCT LIST, press  or  to show the product name, product number and associated program on the display.
-  PRINTER CONNECTED: automatically turns on when the printer is connected.

•  DAYS TO EXPIRY: press  or



 to select the expiry in number of days. The label will show the resulting expiry date.

•  STORAGE TEMPERATURE: press

 or  to select the temperature required to guarantee product conservation.

•  NUMBER OF LABELS: press 

or  to select the number of labels printed in each cycle.

•  LOCK PROGRAM: press  or

 to select ON/OFF. If activated, the vacuum cycle programming keys are blocked in order to guarantee that the packaging parameters are not changed.

To exit, press  again.

LABEL PRINTING:

- Place the roll of labels following the instructions in the printer manual.
- Connect the printer with the supplied cable.



• Turn on the printer: Press "POWER", the "ON LINE" pilot light will turn red, then green. 

is activated during the packaging cycle at the sealing phase when the label is printed.

• To print more than one label during the cycle:

Press the  key to access the label

printing menu. Successively press



to access:

a.  NUMBER OF LABELS: press



or  to select the number of labels printed in each cycle.

- **Extra label:** When a cycle is finished, press after opening the lid before 10s without making another cycle, a new label will be printed.
- **Shut down the printer:** Press and hold the "POWER" button until the "ON LINE" indicator turns red and then turns off.



LABEL PRINTING: VAC-NORM

After having started the vacuum, with the printer activated, when the setpoint vacuum value has been reached the pump stops and one label is printed, indicating the maximum vacuum reached.

BAG CUTTING

The bars, which include wire for cutting bags, are supplied as kits.

Install it by changing the sealing bar for the bar that contains the cutting wire and changing the connection on one of the cables on the sealing transformer to the voltage indicated in the wiring diagram:

To cut the bag, simply set the correct sealing time on the control board and once sealed drag the bag manually along the line marked by the cutting line.

OPERATION AND MAINTENANCE

- Very important: Never pack products if they are still hot, since the vapour generated by them damages the vacuum pump.
- **NEVER** package products using gas with an oxygen content higher than **20%** without first consulting your supplier or SAMMIC-approved service. **This could cause fatal explosions.**

Packaging liquids:



All "SU" models are fitted with a system for detecting the evaporation of a liquid that is being packaged. When the liquid evaporates, the vacuum pressure stops decreasing and if this happens the electronic control stops the

vacuum process and the  symbol lights up. This is done to help prevent liquid from contaminating the vacuum chamber and pump oil.

The  symbol remains lit until a new cycle begins.

Note: Certain mixtures with liquid appearance but beaten with a mixer contain trapped air in the mixture. In such situations the detector may not work optimally, in which case press



the  key to PAUSE or  to prevent the liquid from damaging the oil.

To package liquids, use the accessory that keeps the bag at an angle to avoid spilling the liquid. If bubbles appear during packaging, the saturation point has been reached. The saturation point is similar to the evaporation or boiling point that occurs at different temperatures depending on the pressure.

The saturation point is reached sooner the higher the temperature of the liquid during the vacuum process. It is recommended to cool the liquid before packaging to obtain an optimum vacuum for the product.

The table indicates the saturation point for water with the relationship between temperature and pressure. This table approximately outlines the MAXIMUM VACUUM that can be obtained for each given product temperature.

Vacuum pressure (mbar)	1000	100	50	31,67	20	10	6,09	5	2
Vacuum pressure (%)	0	90,1	95	96,87	98	99	99,4	99,5	99,8
Temp. Evaporation (°C)	100	45	33	25	18	7	0	-2	-13

Drying the oil:

After working with liquids, it is convenient at the end of each day to run an oil drying cycle, which removes moisture contained in the pump and maintains its ability to make the **maximum vacuum**. To do this, select the **DRY OIL** program as indicated in the "OPERATION" section.

Automatic pump shutdown:

In models with continuous pump operation, if the machine is not used for 10 minutes the pump stops automatically. This prevents the oil from overheating, and reduces the amount of oil deposited in the drainage filters, in addition to

saving energy. When the cover is closed, the pump and the cycle start up simultaneously.

- It is important to clean the inside and edges of the chamber and gasket seal every day.

- The outside of the machine must NEVER be cleaned directly with water from a hose. Use a damp cloth and mild detergent for cleaning. Never clean the cover with alcohol, solvents or cleaning products since it can affect the mechanical properties of the material and cause it to break. If a crack is observed on the cover, do not continue working with the machine and inform the authorised repair service, as there is a risk of breaking the cover.

- Only a SAMMIC authorised technical service can replace the power cable if this is damaged.

- Before undertaking any cleaning, inspection or repair work on the machine, the machine must be unplugged from the mains.

- Machine noise level, while running, at a height of 1.6 m and a distance of 1 m, is 75 dB(A). Background noise: 32 dB (A).

Oil change

The oil level must be checked weekly, which should cover 3/4 of the spy hole. Fill it if necessary.

The oil must be changed after the first 100 hours of operation. Then change the oil:

- Desktop models; Model number 2: 150 hours
- Free-standing models; Intermittent pump operation, Model number 1: 300 hours
- Free-standing models; continuous pump operation, Model number 0: 300 hours

• When the pump has worked the hours indicated, when starting the machine the viewer will indicate the hours and the  symbol will light up to warn that the oil must be changed.

• The oil must also be changed if it is observed that is emulsified. The number of hours accumulated can be checked when switching the machine on. To make the change, release vacuum cover and let the used oil out. For filling, follow the instructions given in the corresponding section.

• In pumps 40m³/h and above, the oil filter must be changed at the same time. This filter is of the type used in the car according to the reference: AWS2, thread 3/4.

- The exhaust filter must be replaced every four oil changes or when oil leaks or oil mist are observed in the exhaust.

COMMENTS

If, when the machine is in the vacuum cycle, the sensor detects that the vacuum pressure does not reach the programmed setpoint, after a waiting time the cycle is stopped and changed to the decompression process.

If, upon initiating the decompression process, the lid does not open, after a time the decompression electro-valve disconnects to prevent damage to the valve or to the electronic board.

Other important information:

- Appliance for commercial use only.
- **WARNING:** Disconnect the electric power before servicing.
- This machine is not designed for use by people (including children) with reduced physical, sensory or mental capabilities or lacking the necessary experience or knowledge, unless they have received supervision or instructions from someone responsible for their safety.
- Children must be supervised to ensure that they do not play with the device.
- Cover cleaning:

Warning !

Never use alcohol, solvents or glass-cleaning products to clean the cover, because they may affect the mechanical properties of the material, eventually resulting in damage to the cover. Instead, wash the cover with water and soap. If you ever observe any crack in the cover, stop operating the machine and call the authorised assistance service to come and repair the cover, as there is a risk for the cover to break.

- Vacuum Pump oil:

Warning

Vacuum pump contains oil, do not tilt the machine.

THE BASICS OF VACUUM-PACKING TECHNOLOGY

Vacuum is a method of natural food preservation that consists in removing air from the pack, eliminating oxygen, the principal food spoilage agent.

Advantages of vacuum-packing

1- Maximum reduction of product wastage.

2- Maximum return from labour hours by making good use of any idle times occurring within the week in order to speed up work and to quicken the process flow in the kitchen.

3- Rational storage of products in cold rooms:

- Odors will not mix up.
- Products can be labelled, which facilitates the turnover of raw materials.
- Improvement of inventory control, since anything to be purchased at a given time can be determined with greater accuracy.

4- Exploitation of the best-to-buy days:

- Shopping can be made when prices are lower.
- Less travels are needed.

5- Less washing-up.

Packing of cured products (sausages, hams, etc.)

These per se durable products can see their shelf-life at least doubled when vacuum-packed. Vacuum-packing also prevents them from drying up or losing weight, which would entail an economic loss. Except for some that are fragile in texture, these products require no gas injection.

Packing of cooked food

This concerns such food as roast meats, stews, cannelloni, etc. Once cooked, these products must be cooled down to the core from +65°C to +10°C in less than two hours, in order to prevent microorganisms from developing.

Vacuum-packing is perhaps the most practical

method of maintaining traditional cooking with these advantages:

- Easy food processing, without risk of product spoilage.
- Longer product life.

Cooking of vacuum-packed food

Put food into a tight and heat-resistant container. Remove any air from the inside, seal the container and heat it to cook the food inside.

Cooking is done at low temperatures (65°C to 100°C), producing a pasteurising effect. This process has many advantages. Indeed, among others:

- it maintains the nutritional values.
- It safeguards hygiene, as there is less handling.
- It reduces weight loss, by preventing evaporation and drying.
- It allows rational work planning. Food processing and cooking outside service hours; preparation of banquets in advance, etc.
- It increases the storage time.

Food must be cooled down immediately after cooking, in order to stop the cooking process and to prevent the growth of microorganisms. Cooling is achieved with a temperature reducer.

Refrigerated foods: Temperature at the core of the product must descend from +65°C to +10°C in less than 2 hours.

Frozen foods: Temperature at the core of the product must descend from +65°C to -18°C in less than 4.5 hours..

Thereafter, food is to be kept at a temperature of 0°C to 3°C as for refrigerated dishes and of -18°C if frozen.

When so-packed food is to be prepared to be savoured, the reconstitution process must start immediately after taking the pack out of the fridge or freezer. Basically, there are three reconstitution techniques: the low-pressure steam oven, a bain-marie, and a microwave

oven. In the first two cases, food can be reconstituted within their packing, while the bag must be perforated or removed for reconstitution in a microwave oven, so that steam can escape without the bag bursting.

Any reconstituted product that is not consumed may not be stored again and must be disposed of.

Refrigerated food should not be stored for more than 6-21 days.

Freezing of vacuum-packed food

Conventional freezing techniques allow keeping the product, but not all of its qualities. Freezing vacuum-packed food has many advantages:

- No external frostbiting
- No surface frosting
- No loss of taste or aroma
- No drying
- No oxidation of fats

Indications pour le marquage CE.

Chaque machine possède les identifiants suivants :

- Nom et adresse du fabricant : SAMMIC, S.L. Basarte, 1, Azkoitia Gipuzkoa (ESPAGNE).
- Marquage « CE ».
- Le modèle de machine, tel qu'indiqué au paragraphe suivant.
- Le numéro de série est indiqué sur la garantie et sur la déclaration de conformité.

MODÈLES

Ce manuel décrit l'installation, le fonctionnement et la maintenance des machines à emballer sous vide contrôlé par senseur :

- modèles à poser : SU-310, SU-316, SU-416, SU-420, SU-520
- modèles sur pied : SU-604, SU-606, SU-806, SU-810.
- Modèles sur pieds à double chambre : SU-6000
- Options pur ces modèles :
 - Gaz : « G » Système d'injection de gaz
 - Imprimante : « P » Plaque électronique avec bluetooth pour la connexion avec un smartphone autorisant la création d'étiquettes adhésives
 - Soudure « + » : Permet à l'utilisateur de disposer de plus de puissance de soudure par un simple appui sur une touche pour les sachets métallisés.

La référence et les caractéristiques du modèle sont indiquées sur la plaque signalétique fixée sur la machine.

Ces machines à emballer sont conçues et fabriquées conformément aux directives européennes 89 / 392 / CEE, 93 / 68 CEE, 73 / 23 / CEE et à la norme NSF relative à l'hygiène et à la santé.

INSTALLATION

Afin d'obtenir des performances optimales et d'assurer une bonne conservation de la machine, il est important de respecter soigneusement les instructions données dans ce manuel.

Emplacement

La machine doit être correctement mise de niveau. Pour éviter tout risque d'endommagement, la machine ne doit jamais être en appui sur l'un de ses côtés.

Les machines à poser sur table doivent être

installées sur une surface plane dans la mesure où les pieds sont fabriqués dans un matériau antidérapant pour pouvoir déplacer la machine sans efforts et nettoyer la surface sur laquelle elle repose.

Branchement Électrique

1. Caractéristiques de la machine

- Les modèles monophasés sont fournis pour une tension de 230 V.
- Les modèles triphasés sont fournis pour une tension de 230 V ou 400 V (branchement réalisé en 400 V).

Avant de brancher la machine à emballer au réseau, vérifiez que la tension d'alimentation de l'appareil correspond bien à celle de votre installation électrique.

Pour le changement de tension (uniquement machines triphasées) :

1. Brancher les transformateurs sur la tension adaptée, en fonction de ce qui est indiqué sur le bloc de connexions.
2. Modifier, si nécessaire, les connexions du moteur, comme indiqué sur sa plaque à bornes.
3. Régler si nécessaire le relais thermique en fonction de ce qui est indiqué sur le schéma électrique.

2. Caractéristiques du cordon

Les machines à emballer SAMMIC sont livrées avec un cordon électrique de 1,5 m de longueur, avec recouvrement thermoplastique.

LA MISE À LA TERRE EST OBLIGATOIRE. Le fil de prise de terre de la machine est convenablement repéré. De plus, la machine est équipée d'une vis externe pour la connexion à un système équipotentiel de terre.



- Modèles triphasés : Prévoir une prise de courant murale équipée d'une protection magnétothermique et de différentiel à 3P+N+T de 20 A et une fiche étanche à raccorder au cordon d'alimentation de la machine à emballer.
- Modèles monophasés : Prévoir une prise de courant murale équipée d'une protection magnétothermique et différentiel de 2P+T de 20 A. La fiche du cordon d'alimentation doit être accessible.

3. Changement de sens de rotation de la pompe à vide (uniquement sur les machines

triphasées)

Si le moteur de la pompe à vide émet un bruit anormal lors du démarrage de la machine, cela signifie qu'il tourne dans le sens inverse. Dans ce cas, arrêter immédiatement la machine et intervenir deux des fils de phase.

Remplissage d'huile

La pompe contient déjà de l'huile sur les modèles SU-416, SU-420, SU-520, SU-600, SU-800.

Sur les modèles SU-310, SU-316 remplir d'huile la pompe à partir de l'orifice, jusqu'à compléter aux $\frac{3}{4}$ la fenêtre de visualisation. L'huile utilisée doit être sans détergent :

- Huile SAE10 (sans) pour les pompes jusqu'à 20 m³/h.
- Huile SAE30 (sans détergent) pour les pompes au-delà de 20 m³/h.

Il est recommandé d'utiliser des huiles paraffiniques.

MISE EN ROUTE

Après avoir allumé l'interrupteur général, il est nécessaire d'effectuer plusieurs cycles de vide avant de procéder au premier conditionnement, afin que l'huile chauffe et fournisse un vide correct.



TOUCHE ON/OFF :  Comporte 2 témoins lumineux :

- Rouge en attente avec la machine connectée au réseau. La machine est éteinte sur « OFF ».
- En appuyant sur la touche, le témoin devient bleu : machine allumée « ON ».

Si la machine n'est pas utilisée pendant un certain temps, elle passe automatiquement sur attente OFF.

FONCTIONNEMENT :



TOUCHE :  Chaque appui permet d'accéder à :

-  PROGRAMMES de vide du 1 au 25 : Le numéro de programme clignote et se modifie



par les touches

-  VIDE PAR ÉTAPES : Pour les produits poreux, les viandes préparées, les mélanges émulsionnés contenant de l'air, etc.

3 étapes permettent d'atteindre le vide de consigne, avec un temps d'attente fixe pour chaque étape :

Ex : si la valeur de consigne est de 99 % :

- Étape 1 : 91 %, t = 10 s
- Étape 2 : 95 %, t = 10 s
- Étape 3 : 97 %, t = 10 s
- Fin : 99 %



VIDE EXTÉRIEUR (VAC. NORM) :



Pour bacs Gastronorm spécial vide. Pour pouvoir utiliser cette fonction, il est nécessaire d'acheter le kit VAC-NORM, qui comporte le tuyau et l'adaptateur sur la cuve de la machine à emballer.

- Avant d'activer la fonction VAC-NORM, placer l'adaptateur et le tuyau sur l'aspiration de la machine.
- Placer l'autre extrémité du tuyau dans le bac.



- En appuyant sur la touche  , la pompe démarre jusqu'à ce que le vide obtenu corresponde au vide de consigne programmé. La pompe s'arrête alors et active la décompression pour libérer le tuyau. En



appuyant sur la touche  pendant la durée du vide, la pompe marque une pause et  s'éclaire

- **DRY OIL**, Déshumidification de l'huile : Permet de conserver l'huile dans de bonnes conditions en réduisant l'humidité contenue et permet d'atteindre le maximum de vide de la pompe. Abaisser le couvercle pour que la pompe fonctionne en continu pendant 15 min. La vanne d'entrée d'air s'active toutes les 2 min, sans arrêter la pompe. L'écran central affiche la durée en minutes du temps restant pour la fin du cycle.



- Un appui sur la touche  termine également le processus, sur n'importe lequel des modes de fonctionnement cités précédemment. La phase du programme en cours d'exécution s'arrête et passe sur la phase suivante.

PROGRAMMES DE VIDE :

- Appuyer sur  puis sur 

ou  pour choisir le numéro de programme de **1 à 25**

- Appuyer ensuite sur les touches de cycle et

appuyer sur  ou  pour choisir les valeurs



- **VIDE** : sélection du pourcentage de vide : de 1 % à 99 %



- **VIDE +** : 1 s – 15 s ne fonctionne qu'après avoir sélectionné le vide sur 99 %



- **GAZ** : affiche la **quantité de gaz introduit en %**.

· Ex : pour la sélection de **20 %** de Gaz et de 99 % de Vide l'écran affichera sur le cycle la pression finale de vide à 99 % puis introduira 20 % de gaz en affichant : 99 % – 20 % = **79%**.

· Si la consigne se trouve sur 0 %, **AUCUN** gaz ne sera introduit.



- **SOUDURE** : durée de scellement du sachet : 0 – 7s



- **SOUDURE +** : Si la machine est équipée de ce système (voir les réglages initiaux), il suffit pour l'activer d'effectuer un appui long sur



la touche  jusqu'à voir apparaître l'icône. Cela augmente la puissance de scellement pour des sachets de type métallisé.





- **ATMOSPHÈRE PROGRESSIVE** : entrée d'air doux dans la chambre de 0 – 9s



- Appuyer sur  ou abaisser le couvercle pour effectuer le cycle qui restera également mémorisé.

- Le cycle démarre en abaissant le couvercle.
- **PAUSE VIDE** : En appuyant sur la touche



 pendant la phase de vide, la pompe s'arrête et l'écran affiche le symbole  , le vide étant maintenu. Un nouvel appui démarre la pompe et poursuit le processus de vide.

- Si le verrouillage  est activé, il **NE** permettra **PAS** de modifier les valeurs du programme de conditionnement.

- Pour débloquer un programme, appuyer sur



et en appuyant sur **OK** la touche

 ou 

clignote et un appui sur  ou  permet de choisir **ON/OFF**. Pour quitter,



appuyer sur

PROCÉDURE DE MISE EN ROUTE et RÉGLAGES INITIAUX :



Le numéro de modèle s'affiche sur l'écran central dans les 3 premières secondes. Le symbole  s'affiche également et l'écran à 11 caractères affiche le nombre d'heures de fonctionnement de la pompe, pour le contrôle du remplacement de l'huile.

Réglages possibles dans les 3 premières secondes :

- **Numéro de modèle** : Effectuer un appui **long**



de **2 s** sur  . Régler le numéro de

modèle en appuyant sur  ou  jusqu'à afficher le numéro de modèle :

Modèles AVEC système d'injection de Gaz :

- N° « 0 » : Machines sur pied, fonctionnement continu : SU-600, SU-800, SU-6000. La pompe est en marche dès lors que l'interrupteur général est enclenché. Cette configuration a été conçue pour les machines qui sont installées dans des endroits froids ou des chambres frigorifiques.
- N° « 1 » : Machines sur pied, fonctionnement intermittent : SU-600, SU-800, SU-6000. La pompe est en marche pendant la phase de

vide et de soudure.

- N° « 2 » : Machines à poser sur table, fonctionnement intermittent : SU-300, SU-400, SU-500. La pompe est en marche uniquement pendant la phase de vide.

Modèles SANS système d'injection de Gaz :

Les mêmes modèles sont configurés selon le même mode de fonctionnement de la pompe que les précédents, mais sans Gaz.

- N° « 3 » :
- N° « 4 » :
- N° « 5 » :

- **SOUDURE + (En option)** : Si la machine est équipée de ce système, un appui sur la touche



active le symbole  pour chaque numéro de modèle choisi.

- **Langue et date** : Effectuer un appui long de 2 s



sur  pour régler la langue, la date, l'heure et la température :

1. LANGUE



- « Español » clignote, appuyer



sur  ou  jusqu'à choisir "English", "Français", "Deutsch", "Italiano",



"Português" appuyer sur



2. DATE (Uniquement les modèles avec plaque bluetooth-imprimante)

- Affichage de la date : **jj/mm/aaaa**



• Lorsque jj clignote, appuyer sur



ou  et , le clignotement s'arrête et passe sur :

- **mm** appuyer sur  ou  et



- **aaaa** appuyer sur  ou  et



3. HEURE

- **xx H**  ou  et 

- **xx MIN**  ou  et 







- **Heures Pompe** : Appuyer sur  dans les 3 premières secondes. Pour effectuer une réinitialisation des heures de fonctionnement de la pompe.



- **Test écran LCD** : Appuyer sur  dans les 3 premières secondes. Pour effectuer un test de l'écran LCD et vérifier les segments de l'écran : TOUS les symboles s'allument pendant **2 s**.

- **N° Bluetooth (modèles avec option**

imprimante) : Appuyer sur  dans les 3 premières secondes et l'icône d'activation  s'affichera. L'écran alphanumérique affichera un nombre à 4 chiffres : « **SU XXXX** ». Ce nombre doit correspondre au numéro affiché sur l'application (APP) du porteur 

- **Versión programme** : Appuyer sur  dans les 3 premières secondes. L'écran alphanumérique affichera le numéro de version du programme que la plaque électronique utilise.

Après avoir terminé chaque réglage, appuyer



sur  pour éteindre la machine puis l'allumer à nouveau pour accéder à d'autres réglages ou au fonctionnement normal.

CRÉATION ET IMPRESSION D'ÉTIQUETTES :

- L'application développée pour les smartphones ou tablettes permet à l'utilisateur d'écrire une liste jusqu'à 50 produits :
- **Nom de l'établissement** : « 30 caractères »

- **Produit** : « 40 caractères »

• **Date de Conditionnement** : Ex. « 10/11/2016 » (Automatique en fonction de la date sur la machine)

• **Vide** : Ex. « 99 % » Gaz : Ex. « 20 % » (Automatique en fonction de la valeur de vide et de gaz effectué par la machine)

• **Température Conservation** : en °C, °F en fonction des réglages dans l'application pour l'impression des étiquettes (APP)

• **À consommer avant** : les jours de péremption sont introduits et la date de péremption calculée à partir de la date de conditionnement s'affiche sur l'étiquette.

- **Le produit « 0 »** s'affiche sur l'écran en tant que « ÉTIQUETTE MANUELLE » et autorise uniquement l'impression de l'étiquette avec les valeurs automatiques de « Date Conditionnement » et « VIDE ». Les autres restent vides pour écrire manuellement sur l'étiquette.

DESCRIPTION APPLI POUR SMARTPHONE - TABLETTE

L'application est téléchargée sur un téléphone portable ou une tablette :

- Système Android : « Play Store »
- Système iPhone : « Apple Store »

1. Ouvrir l'application SAMMIC VACUUM



TOUCHE : « IMPRESSION D'ÉTIQUETTES »

(Uniquement les modèles équipés de plaque Bluetooth)



La touche  permet d'accéder au menu d'impression des étiquettes. Appuyer



ensuite sur  pour accéder à :



- **LISTE DE PRODUITS** appuyer sur



ou  pour afficher sur l'écran le nom de produit, le numéro de produit et le programme associé.



- **IMPRIMANTE CONNECTÉE** : s'allume automatiquement dès que l'imprimante se connecte.

-  **JOURS DE PÉREMPTION** : appuyer

sur  ou , pour sélectionner la péremption en nombre de jours. L'étiquette affichera la date de péremption qui en découle.



-  **TEMPÉRATURE CONSERVATION** :

appuyer sur  ou  pour sélectionner la température nécessaire qui garantit la conservation du produit.

-  **NOMBRE D'ÉTIQUETTES** : appuyer sur

 ou  pour sélectionner le nombre d'étiquettes qui seront imprimées pour chaque cycle.

-  **VERROUILLAGE DU PROGRAMME** :

appuyer sur  ou  pour sélectionner ON/OFF. Quand le verrouillage est activé, les touches de programmation du cycle de vide sont verrouillées, afin de garantir que les paramètres de conditionnement ne seront pas modifiés.

- Pour quitter, appuyer à nouveau sur 

IMPRESSION D'ÉTIQUETTES :

- Mettre en place le rouleau d'étiquettes en suivant les instructions contenues dans le manuel de l'imprimante
- Brancher l'imprimante avec le câble fourni.



- Allumer l'imprimante : Appuyer sur « **POWER** », le témoin lumineux « **ON LINE** » s'allume



en rouge puis passe en vert. Activer  Lors du cycle de conditionnement en arrivant à l'étape de soudure l'étiquette s'imprime.

- Pour imprimer plus d'une étiquette lors du cycle :

La touche  permet d'accéder au menu d'impression des étiquettes. Appuyer

ensuite sur  pour accéder à :

- a.  **NOMBRE D'ÉTIQUETTES** :

appuyer sur  ou  pour sélectionner le nombre d'étiquettes qui seront imprimées pour chaque cycle.

- **Étiquette supplémentaire** : Après avoir

finalisé un cycle, en appuyant sur  une fois le couvercle ouvert dans les 10 secondes sans effectuer de nouveau cycle, une nouvelle étiquette s'imprime.

- Éteindre l'imprimante : Maintenir appuyé le bouton « **POWER** » jusqu'à ce que le témoin lumineux « **ON LINE** » devienne rouge puis s'éteigne.



IMPRESSION D'ÉTIQUETTES : VAC-NORM

Après avoir lancé le vide, à imprimante activée, la pompe s'arrête lorsqu'elle atteint la valeur de vide de consigne et 1 étiquette est imprimée, indiquant le vide maximum atteint.

COUPURE DU SACHET

Les barres munies de fil permettant de couper les sachets sont fournies en kits.

Leur montage s'effectue en remplaçant la barre de soudure par la barre pourvue de fil de coupe et en transférant la connexion de l'un des fils dans le transformateur de soudure sur la tension indiquée sur le schéma électrique :



Pour couper le sachet, il suffit de programmer

le temps de soudure souhaité sur la plaque de commande et une fois soudé, le sac se détache manuellement en tirant le long de la ligne marquée par le fil de coupe.

UTILISATION ET ENTRETIEN

- Très important : Ne pas emballer de produits à chaud, puisque la vapeur qu'ils produisent endommagerait la pompe à vide.
- **NE JAMAIS** conditionner sous vide avec du gaz des produits ayant une teneur en oxygène supérieure à **20 %** sans avoir auparavant consulté votre fournisseur ou un service agréé SAMMIC. **Cela peut provoquer des explosions mortelles.**

Emballage sous vide de liquides :

Tous les modèles « SU » sont équipés d'un système de détection de l'évaporation d'un liquide qui est en cours de conditionnement. Lors de la production de l'évaporation d'un liquide, la pression de vide cesse de diminuer et dans ce cas le contrôle électronique arrête le processus de vide et le symbole  s'allume. Ceci afin d'éviter que le liquide salisse la chambre de vide et l'huile de la pompe. Le symbole  reste allumé jusqu'au début d'un nouveau cycle.

Note : Certaines préparations ressemblant à du liquide mais passées au batteur contiennent de l'air piégé dans le mélange. Dans ce type de situation, il est possible que le détecteur ne fonctionne pas parfaitement. Il est alors

nécessaire d'appuyer sur la touche 

pour mettre en PAUSE ou  pour éviter que le liquide vienne abîmer l'huile.

Pour l'emballage sous vide de liquides, il convient d'utiliser l'accessoire qui maintient le sachet incliné pour éviter la fuite de liquide. Si des bulles apparaissent lors du conditionnement, cela signifie que le point de saturation a été atteint. Le point de saturation est similaire au point d'évaporation-ébullition se produisant à différentes températures en fonction de la pression.

Plus la température du liquide lors du processus de vide est élevée, plus le point de saturation est atteint rapidement. Nous recommandons

avant toute chose de laisser refroidir le liquide avant de le conditionner, afin d'obtenir un vide optimal du produit.

Un tableau du point de saturation de l'eau est présenté, indiquant le rapport entre la température et la pression. Cela indique de manière approximative le VIDE MAXIMAL qui peut être obtenu pour chaque température indiquée du produit.

Vacuum pressure (mbar)	1000	100	50	31,67	20	10	6,09	5	2
Vacuum pressure (%)	0	90,1	95	96,87	98	99	99,4	99,5	99,8
Temp. Evaporation (°C)	100	45	33	25	18	7	0	-2	-13

Déshumidification de l'huile :

Après avoir travaillé avec des liquides, il convient à la fin de chaque journée d'effectuer un cycle de déshumidification de l'huile qui élimine l'humidité contenue dans la pompe et conserve sa capacité à effectuer un vide maximal. Pour cela, sélectionner le programme **DRY OIL** en fonction de ce qui est indiqué au chapitre « FONCTIONNEMENT »

Arrêt automatique de la pompe :

Sur les modèles avec fonctionnement en continu de la pompe, si la machine N'EST PAS utilisée pendant 10 min, la pompe s'arrête automatiquement. Cela évite une surchauffe de l'huile et réduit la quantité d'huile déposée sur les filtres d'expulsion, tout en économisant de l'énergie. En refermant le couvercle, la pompe et le cycle démarrent simultanément.

-Il est important de laver chaque jour l'intérieur et les bords de la chambre ainsi que le joint de fermeture.

-L'extérieur de la machine ne doit pas être nettoyé par jet direct d'eau. Utiliser pour son nettoyage un chiffon humide et n'importe quel détergent habituel. Ne jamais nettoyer le couvercle avec de l'alcool, des solvants ou des produits pour les vitres car ceux-ci pourraient en altérer les propriétés mécaniques et le casser. Si vous remarquez une fissure sur le couvercle, arrêtez d'utiliser la machine et contactez le service technique agréé pour la faire réparer, car il existe un risque de rupture.

-Si le câble d'alimentation est détérioré et il convient d'en installer un neuf, ce remplacement ne pourra être effectué que par

un service technique agréé par SAMMIC.

-Avant toute intervention pour le nettoyage, la révision ou la réparation de la machine, il est obligatoire de débrancher la machine du réseau électrique.

-Le niveau de bruit de la machine, en marche, placée à 1,6 m de hauteur et à 1 m de distance, est de 75 dB(A). Bruit de fond : 32 dB (A).

Changement d'huile

Il est nécessaire de contrôler toutes les semaines le niveau d'huile, qui doit atteindre les 3/4 du niveau visible. Le compléter, si nécessaire.

L'huile doit être changée après les 100 premières heures de fonctionnement. Changer l'huile ultérieurement :

- Modèles à poser ; Numéro de modèle 2 : 150 heures
- Modèles sur pied ; Pompe fonctionnement intermittent, Numéro de modèle 1 : 300 heures
- Modèles sur pied ; Pompe fonctionnement continu, Numéro de modèle 0 : 300 heures
- Lorsque la pompe a travaillé pendant le nombre d'heures indiqué, en allumant la machine l'écran indiquera les heures, et le symbole  s'allumera pour prévenir de la nécessité de changer l'huile.
- L'huile devra également être remplacée quand elle est émulsionnée. Lors de l'allumage de la machine, le nombre d'heures de travail cumulées s'affiche. Pour changer l'huile, enlever le bouchon de vidange et laisser s'écouler l'huile usagée. Pour effectuer le remplissage, suivez les indications données dans le paragraphe correspondant.
- Pour les pompes de 40m³/h et plus, vous devrez changer en même temps le filtre à huile. Ce filtre est semblable à ceux utilisés pour les voitures. La référence est la suivante : AWS2, filetage 3/4.
- Le filtre d'échappement doit être changé toutes les 4 vidanges ou en cas de pertes d'huile ou de brouillard d'huile à l'échappement.

REMARQUES

Lorsque la machine est en cours de cycle de vide, si le capteur détecte que la pression de vide ne parvient pas à la consigne programmée, après un temps d'attente, le cycle s'arrête et passe à la décompression.

Si lorsque la décompression est effectuée, le couvercle ne s'ouvre pas, après un temps l'électrovanne de décompression se déconnecte afin d'éviter son endommagement ou celui de la plaque électronique.

Autres observations importantes :

- Machine destiné pour usage industriel.
- ATTENTION: Debrancher l'alimentation électrique pour maintenance.
- Cet appareil n'est pas destiné à être utilisé par des personnes (enfants inclus) dont les capacités physiques, sensorielles ou mentales sont réduites, ou n'ayant pas les connaissances et l'expérience nécessaires, sauf si elles ont reçu des instructions concernant l'usage de l'appareil et si elles sont sous la supervision d'une personne responsable de leur sécurité.
- Les enfants doivent être surveillés afin de garantir qu'ils ne jouent pas avec l'appareil.
- Nettoyage du couvercle

Attention !

N'utilisez jamais d'alcool, de solvants ni de produits lave-vitres pour nettoyer le couvercle car ces produits pourraient altérer les propriétés mécaniques du matériel et faire se casser le couvercle. Le couvercle doit être uniquement nettoyé à l'eau et au savon. Si jamais vous observez une fissure sur le couvercle, arrêtez la machine et appelez le service technique agréé pour faire réparer le couvercle car il pourrait arriver à se casser.

- Pompe à huile

Attention:

La pompe à vide contient de l'huile. Ne pas incliner la machine

GENERALITES CONCERNANT LE CONDITIONNEMENT SOUS VIDE

Le vide est une technique de conservation naturelle consistant à extraire l'air de l'intérieur de l'emballage en éliminant l'oxygène, principal facteur d'altération des aliments.

Avantages du conditionnement sous vide

- 1- Il réduit au minimum les pertes de poids des produits.
- 2- Il rentabilise au mieux les heures de travail du personnel grâce à l'utilisation des temps morts pouvant se produire pendant la semaine pour avancer le travail et mieux répartir la charge de travail dans les cuisines.
- 3- Il rationalise le stockage des produits dans les chambres froides :
 - Il n'y a pas de mélange des odeurs.
 - Les produits sont étiquetés, ce qui permet une bonne rotation des matières premières.
 - Le contrôle des stocks est facilité car les achats nécessaires à chaque moment peuvent être calculés avec précision.
- 4- Il permet une meilleure gestion des achats :
 - Groupement des achats lorsque les prix sont les plus intéressants.
 - Réduction des déplacements.
- 5- Il réduit le lavage des ustensiles de cuisine.

Conditionnement de produits séchés (charcuterie, jambon, etc.)

Ces produits qui ont déjà naturellement une date limite de consommation élevée, voient leur durée de vie doublée grâce au conditionnement sous vide qui évite également leur dessèchement ou les pertes de poids (et donc les pertes économiques). Ces produits n'ont pas besoin d'être conditionnés sous atmosphère contrôlée, sauf ceux de texture fragile.

Conditionnement de produits cuisinés

C'est le cas des produits comme les rôtis, ragoûts, cannelonis, etc. Une fois cuisinés, ces aliments doivent impérativement passer de + 65°C à + 10°C à coeur en moins de deux heures, afin d'éviter le développement de micro-organismes. C'est le moyen le plus pratique de maintenir une cuisine traditionnelle avec les avantages suivants :

- Plus grande facilité de travail au niveau des préparations, sans risque de perte du produit.

- Augmentation de la durée de vie du produit.

Cuisson de produits conditionnés sous vide

Cette technique consiste à introduire un aliment dans un sac étanche et thermorésistant, à extraire l'air de l'intérieur du sac, puis de le souder et de le soumettre à l'action d'une source de chaleur pour cuire l'aliment. La cuisson est réalisée à basse température (entre 65°C et 100°C), opérant un effet de pasteurisation. Ce système offre de nombreux avantages tels que :

- Préservation des qualités nutritionnelles.
- Optimisation des conditions d'hygiène grâce à la réduction des manipulations.
- Réduction des pertes de poids à la cuisson, en limitant l'évaporation et le dessèchement.
- Rationalisation de la planification du travail. Préparation et cuisson en dehors des heures de service, préparation à l'avance des banquettes, etc.
- Augmentation de la durée de conservation.

Le produit doit être refroidi rapidement au terme de la cuisson, afin de stopper la cuisson et d'empêcher le développement de micro-organismes. Pour cette opération, on utilise un abaisseur de température.

Plats réfrigérés : Passage de la température des aliments de + 65°C à + 10°C à coeur en moins de 2 heures.

Plats surgelés : Passage de la température des aliments de + 65°C à -18°C à coeur en moins de 4h 1/2.

Le stockage ultérieur doit maintenir les plats réfrigérés à une température de 0°C à 3°C et les plats surgelés à -18°C.

Pour la remise en température des aliments au moment de leur consommation, le processus de régénération doit intervenir immédiatement après la sortie du produit du réfrigérateur où il était stocké. Les matériels de remise en température sont essentiellement trois : le four vapeur à basse pression, le bain-marie et le micro-ondes. Dans les deux premiers cas, les produits sont réchauffés dans leurs emballages, tandis que dans le cas du four à micro-ondes, il faut soit percer l'emballage pour que la vapeur puisse sortir sans faire éclater le sac, soit réchauffer le produit hors de son emballage.

Les produits réchauffés n'ayant pas été consommés ne peuvent pas être stockés de nouveau. Ils doivent être impérativement jetés.

Le temps de stockage des plats réfrigérés ne doit pas dépasser 6-21 jours.

Conditionnement sous atmosphère contrôlée

Cette technique consiste à remplacer l'air environnant l'aliment par un mélange de gaz de proportion différente à celui de l'air, dans deux objectifs :

- Prolonger la vie du produit, sans mettre d'additifs ni de conservateurs, en inhibant les phénomènes de dégradation ayant lieu pendant le stockage.
- Eviter l'écrasement de produits tels que viennoiseries, salades, etc.

On utilise essentiellement trois gaz : O₂, CO₂ et N₂, ou un mélange de ceux-ci. D'une manière générale, une plus grande concentration de CO₂ (contrôlée) augmente la durée de vie du produit, tandis qu'une certaine quantité de N₂ évite la rupture des emballages dans le cas des produits à niveau métabolique élevé et qu'une petite proportion d'O₂ assure le maintien du bon état et de l'aspect de certains aliments.

Il est recommandé de consulter les fabricants de gaz pour produits alimentaires qui vous aideront à choisir le mélange de gaz convenant le mieux à chaque produit.

Surgélation des produits conditionnés sous vide

Les techniques traditionnelles de surgélation conservent bien le produit mais non sa qualité. La surgélation des produits conditionnés sous vide présente de nombreux avantages :

- Pas de croûte extérieure
- Pas de cristallisation de la surface
- Pas de perte de goût ni d'arôme
- Pas de dessèchement
- Pas d'oxydation des matières grasses

Indicazioni per il mercato CE.

Ogni macchina ha i seguenti identificatori:

- Nome e indirizzo del costruttore: SAMMIC S.L. - Basarte 1 Azkoitia Gipuzkoa (SPAIN).
- Marca "CE".
- Si indica il modello della macchina nel seguente paragrafo.
- Il numero di serie è riportato sul certificato di garanzia e sulla dichiarazione di conformità.

MODELLI

Il presente manuale descrive l'installazione, il funzionamento e la manutenzione delle confezionatrici sottovuoto controllato a sensor:

- modelli da appoggio: SU-310, SU-316, SU-416, SU-420, SU-520
- modelli a stativo: SU-604, SU-606, SU-806, SU-810.
- Modelli a stativo a doppia camera: SU-6000
- Opzioni per questi modelli:

- Gas: "G" Sistema d'iniezione a gas
- Stampante: "P" Piastra elettronica con bluetooth per la connettività con uno smartphone consentendo la creazione di etichette adesive
- Saldatura "+": Premendolo consente all'utente di ottenere una maggiore potenza di saldatura per i sacchetti metallici

Il riferimento del modello e le caratteristiche sono indicate sulla targhetta d'identificazione apposta sulla macchina.

Queste confezionatrici sono state progettate e fabbricate in conformità alle Direttive Europee 89 / 392 / CEE, 93 / 68 CEE, 73 / 23 / CEE e alla normativa NSF su igiene e sanità.

INSTALLAZIONE

Per ottenere le migliori prestazioni, come pure una buona conservazione della macchina, bisogna seguire attentamente le istruzioni contenute in questo manuale.

Posizionamento

Collocare la macchina in modo tale che rimanga debitamente livellata. Onde evitare danni, non appoggiare mai la macchina su uno dei suoi lati. Le macchine da appoggio si devono installare su una superficie liscia, poiché i piedini sono realizzati in materiale scorrevole per potere spostare la macchina senza sforzo e pulire la superficie su cui appoggia.

Collegamento elettrico

1. Caratteristiche della macchina

- Le macchine monofase si forniscono per una tensione di 230 V.
 - Le macchine trifase si forniscono per tensioni di 230 V o 400 V (collegate a 400 V).
- Prima di collegare la confezionatrice alla rete,

assicurarsi che la macchina sia predisposta per lo stesso voltaggio di rete.

Per il cambio di voltaggio (solo macchine trifase):

1. Collegare i trasformatori alla tensione adatta, come indicato sulla morsettiere.
2. Se necessario cambiare i collegamenti del motore, come indicato sulla morsettiere.
3. Se necessario, adattare il relè termico come indicato nello schema elettrico.

2. Caratteristiche del cavo

Le riempitrici SAMMIC vengono fornite con un cavo elettrico lungo 1,5 m, con rivestimento termoplastico.

IL COLLEGAMENTO A TERRA È OBBLIGATORIO. Il filo di presa di terra della macchina è segnalato. La macchina è dotata anche di una vite esterna per il collegamento a un sistema equipotenziale di terra.



- Macchine trifase: Predisporre una presa di corrente a muro con protezione magnetotermica e differenziale 3P+N+T da 20 A e una spina a tenuta da collegare al cavo di alimentazione della confezionatrice.

- Macchine monofase: Predisporre una presa di corrente a muro con protezione magnetotermica e differenziale 2P+T da 20 A. La spina che fa parte del cavo di alimentazione deve essere accessibile.

3. Modifica del senso di rotazione della pompa a vuoto (solo sulle macchine trifase)

All'avvio della macchina, un eventuale rumore anomalo prodotto dal motore della pompa a vuoto è dovuto alla rotazione inversa di quest'ultima. In tal caso, fermare immediatamente la macchina e scambiare i fili di alimentazione.

Riempimento con olio

Nei modelli SU-416, SU-420, SU-520, SV-600, SU-800 la pompa contiene già l'olio.

Nei modelli SU-310, SU-316 riempire d'olio la pompa dalla bocchetta fino a $\frac{3}{4}$. Utilizzare olio senza detergenti:

- Olio SAE10 (senza detergente) per pompe fino a 20 m³/h.
- Olio SAE30 (senza detergente) per pompe superiori a 20 m³/h.

Si raccomanda che gli oli utilizzati siano paraffinici.

AVVIAMENTO

Una volta azionato l'interruttore generale, ai fini di scaldare l'olio e permettere così un

vuoto corretto, è necessario eseguire vari cicli a vuoto prima di procedere con il primo confezionamento.



TASTO ON/OFF: È dotato di 2 spie:



- Rosso in standby con la macchina collegata all'alimentazione elettrica. La macchina è spenta, in posizione "OFF".
 - Quando si preme il tasto diventa blu: macchina accesa in posizione "ON".
- Se per un periodo la macchina non viene usata, passa automaticamente in standby OFF.

FUNZIONAMENTO:



TASTO: A ogni pressione si accede a:

-  PROGRAMMI di vuoto da 1 a 25: Lampeggia il numero di programma a cui si

accede mediante i tasti  

-  **VUOTO IN VARIE FASI:** Per prodotti porosi, carni lavorate, miscele emulsionate con aria interna del prodotto, ecc. Si eseguono 3 fasi, fino a ottenere il vuoto come da set point con un tempo di attesa fisso per ciascuna fase:

Ad es: se il valore di set point è 99%:

- Fase 1: 91%, t = 10 sec
- Fase 2: 95%, t = 10 sec
- Fase 3: 97%, t = 10 sec
- Fase finale: 99%



VUOTO ESTERNA (VAC. NORM):

Per vaschette Gastronorm apposite per il vuoto. Per poter utilizzare questa funzione è necessario disporre del kit VAC-NORM, contenente il manicotto e l'adattatore alla vaschetta della confezionatrice.

- Prima di attivare la funzione VAC-NORM, posizionare l'adattatore e il manicotto nell'aspirazione della macchina.
- Sistemare l'altra estremità del manicotto nella vaschetta.



- Quando si preme il tasto  parte la pompa, che funziona fino a quando si ottiene il vuoto come da set point, quindi si ferma e si attiva la decompressione per liberare il tubo.



Premendo  durante il vuoto, la pompa fa una pausa e si illumina 

- **DRY OIL**, Asciugatura dell'olio: Consente di mantenere l'olio in buone condizioni riducendo l'umidità contenuta, che permette di raggiungere il massimo vuoto della pompa. Si abbassa il coperchio e la pompa funziona in continuo per 15 min. Ogni 2 min. si attiva la valvola di ingresso dell'aria, senza arrestare la pompa. Sul display centrale compare il tempo in minuti rimanente per concludere il ciclo.



- Premendo  si termina il processo in una qualsiasi tra le modalità di funzionamento summenzionate. Si arresta la fase del programma in esecuzione e si passa alla successiva.

PROGRAMMI DI VUOTO:



- Si preme  e si preme 



o  per selezionare il numero di programma da **1 a 25**

- Quindi si premono i tasti del ciclo e poi si



preme  o  per selezionare i valori



- **VUOTO**: si seleziona la percentuale di vuoto: da 1% a 99%



- **VUOTO +**: 1 sec – 15 sec funziona soltanto se è stato selezionato il vuoto 99%



- **GAS**: mostra la **quantità di gas inserita in %**.

- Ad es: selezionando **20%** di Gas e 99% di Vuoto il display visualizzerà nel ciclo la pressione finale del vuoto al 99% poi inserirà il 20% di gas mostrandolo sul display: 99% – 20% = **79%**.

- Se il set point è 0% **NON** si inserisce gas.



- **SALDATURA**: tempo di sigillatura del sacchetto: 0 – 7 sec



- **SALDATURA +**: Se la macchina è dotata di questo sistema (si vedano le impostazioni iniziali), per attivare sufficientemente tenere premuto il tasto  fino a quando si attiva l'icona. Per i sacchetti di tipo

metallico è necessario umentare la potenza di sigillatura.



- **ATMOSFERA PROGRESSIVA**: entrata di soft air nella camera da 0 a 9 sec





- Si preme  o si abbassa il coperchio per eseguire il ciclo, che resterà memorizzato.

- Abbassando il coperchio si avvia il ciclo.

- **PAUSA VUOTO**: Durante la fase di vuoto,







premando il tasto  la pompa si arresta e sul display compare il simbolo , mantenendo il vuoto. Premendolo di nuovo, la pompa riparte continuando il processo di vuoto.

- Nel caso in cui il blocco  rimanga attivo **NON** sarà possibile modificare i valori del programma di confezionamento.

- Per sbloccare un programma si preme



 e premendo OK lampeggia  e premendo  o  si seleziona ON/OFF. Per uscire bisogna premere

PROCEDURA DI ACCENSIONE e IMPOSTAZIONI INIZIALI:

Durante i primi 3 secondi viene visualizzato il numero di modello sul display centrale. Si accende anche il simbolo  e sul display a 11 caratteri è possibile visualizzare il numero di ore di funzionamento della pompa, per tenere sotto controllo il momento della sostituzione dell'olio. Impostazioni possibili entro i primi 3 secondi:

- **Numero di modello**: Tenendo  premuto per 2 sec. Si imposta il numero di



modello poi si preme  o  fino a quando compare il numero del modello:

Modelli dotati di sistema di iniezione a Gas:

- N. "0": Macchine a stativo e funzionamento continuo: SU-600, SU-800, SU-6000. La pompa è in funzione dal momento in cui viene azionato l'interruttore generale. Questa configurazione è pensata per le macchine installate in luoghi freddi o celle frigorifere.

- N. "1": Macchine a stativo, funzionamento intermittente: SU-600, SU-800, SU-6000. La pompa è in funzione durante la fase di vuoto e sigillatura.

- N. "2": Macchine da appoggio, funzionamento intermittente: SU-300, SU-400, SU-500. La pompa è in funzione soltanto durante la fase di vuoto.

Modelli SENZA sistema con iniezione a Gas:

Con la stessa modalità di funzionamento della pompa rispetto ai modelli precedenti, si configurano i medesimi modelli ma senza sistema di iniezione a gas.

- N. "3":

- N. "4":

- N. "5":

- **SALDATURA + (Opzionale)**: Se la macchina è dotata di questo sistema, per ogni numero di modello selezionato premendo il tasto



si attiva il simbolo



- **Lingua e data**: Tenendo  premuto per 2 sec Si impostano lingua, data, ora e temperatura:

1. LINGUA



- Lampeggia "Español" premere



o  fino a selezionare:

"English", "Francais", "Deutsch", "Italiano",



"Português" premere

2. DATA (Solo modelli con piastra bluetooth-stampante)

- Mostra data: gg/mm/aaaa

- Lampeggia gg premere  o 



e  smette di lampeggiare passando a:



- mm premere  o  e



- aaaa premere  o  e



3. ORA



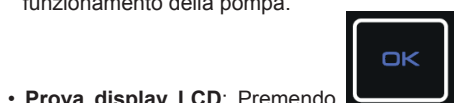

• **Ore Pompa:** Premendo  durante i primi 3 sec. Si resettano le ore di funzionamento della pompa.



• **Prova display LCD:** Premendo  durante i primi 3 sec. Si prova il display LCD per verificarne i segmenti: si accendono TUTTI i simboli per 2 sec.

• **N. Bluetooth (modelli opzione stampante):**

Premendo  durante i primi 3 sec. comparirà l'icona  attivata e sul display alfanumerico un numero di 4 cifre: "SU XXXX". Questo numero deve corrispondere a quello che compare sull'applicazione (APP) del cellulare.

• **Versione programma:** Premendo  durante i primi 3 sec. compare sul display alfanumerico il numero di versione del programma che utilizza la piastra elettronica.

Una volta confermata ogni impostazione si

preme  per spegnere la macchina, poi la si riaccende per accedere alle altre impostazioni o al funzionamento normale.

CREAZIONE E STAMPA DI ETICHETTE:

- Nell'applicazione sviluppata per cellulare-tablet l'utente prepara una lista che può contenere fino a 50 prodotti dove può scrivere:
 - **Nome dello stabilimento:** "30 caratteri"
 - **Prodotto:** "40 caratteri"
 - **Data di confezionamento:** Es. "10/11/2016" (Automatico in funzione della data impostata sulla macchina)
 - **Vuoto:** Es. "99%" Gas: Es. "20%" (Automatico in funzione del valore di vuoto e di gas realizzato dalla macchina)
 - **Temperatura Conservazione:** in °C o °F a seconda delle impostazioni nell'applicazione

per la stampa di etichette (APP)

• **Consumare entro:** si inseriscono i giorni di shelf life e sull'etichetta compare la data di scadenza calcolata a partire dalla data di confezionamento

• Il prodotto "0" viene visualizzato sul display come "ETICHETTA MANUALE" e consente soltanto la stampa dell'etichetta con i valori automatici di "Data di confezionamento" e "VUOTO". I restanti campi rimangono liberi per poter scrivere a mano sull'etichetta.

DESCRIZIONE APP PER SMARTPHONE – TABLET

Si installa l'applicazione su un cellulare o tablet:

- Sistema Android: "Play Store"
- Sistema iPhone: "Apple Store"

1. Aprire l'applicazione SAMMIC VACUUM



TASTO: "STAMPA ETICHETTE" (Solo modelli dotati di piastra bluetooth)



Premendo il tasto  si accede al menù della stampa delle etichette. Premendo poi



si accede a:

•  **ELENCO DEI PRODOTTI** premendo



si visualizza sul display il nome del prodotto, il numero del prodotto e il programma associato.

•  **STAMPANTE CONNESSA:** si accende automaticamente quando si collega la stampante.

•  **GIORNI DI SHELF LIFE:** premendo



si seleziona la shelf life espressa in numero di giorni. Sull'etichetta comparirà la rispettiva data di scadenza.

•  **TEMPERATURADI CONSERVAZIONE:**





premando  si seleziona la temperatura necessaria a garantire la conservazione del prodotto.

•  **NUMERO DI ETICHETTE:** premendo



si seleziona il numero di etichette che si stamperanno in ogni ciclo.

•  **BLOCCO DEL PROGRAMMA:** premendo  si seleziona ON/OFF. Se è attivo si bloccano i tasti di programmazione del ciclo del vuoto per assicurare che non vengano modificati i parametri di confezionamento.



• Per uscire, premere di nuovo

STAMPA DI ETICHETTE:

- Posizionare il rotolo delle etichette seguendo le istruzioni contenute nel manuale della stampante
- Collegare la stampante al cavo fornito in dotazione.



• Accendere la stampante: Premere "POWER", la spia "ON LINE" diventa rossa e poi

verde. Si attiva  Durante il ciclo di confezionamento, in fase di sigillatura, viene stampata l'etichetta.

• Se si desidera stampare più di un'etichetta durante il ciclo:



Premendo il tasto  si accede al menù della stampa delle etichette. Premendo



poi  si accede a:

a.  **NUMERO DI ETICHETTE:** premendo



si seleziona il numero di etichette che si stamperanno in ogni ciclo.

• **Etichetta extra:** Una volta concluso un ciclo,



premando  una volta aperto il coperchio entro 10 sec senza che venga effettuato un altro ciclo, viene stampata una nuova etichetta.

• Spegnimento della stampante: Tenere premuto il tasto "POWER" fino a quando la spia "ON LINE" diventa rossa poi si spegne



STAMPA DI ETICHETTE: VAC-NORM

Dopo aver avviato il vuoto, con la stampante attivata, quando si raggiunge il valore di vuoto del set point la pompa si ferma e si stampa 1 etichetta indicando il vuoto massimo ottenuto.

TAGLIO DEL SACCHETTO

Le barre che contengono il filo per il taglio del sacchetto vengono fornite come kit.

L'installazione si esegue sostituendo la barra di sigillatura con la barra che contiene il filo da taglio e cambiando il collegamento di uno dei cavi nel trasformatore di sigillatura alla tensione indicata sullo schema elettrico:

Per eseguire il taglio del sacchetto, è sufficiente programmare sulla piastra di comando il tempo indicato per la sigillatura e una volta sigillato, si strappa manualmente il sacchetto seguendo la linea delineata dal filo da taglio.

UTILIZZO E MANUTENZIONE

- Molto importante: Non confezionare prodotti a caldo, dato che il vapore che sprigionano danneggia la pompa per vuoto.
- **NON CONFEZIONARE MAI** prodotti usando gas che abbia un contenuto in ossigeno superiore al **20%** senza aver previamente consultato il fornitore o il servizio di assistenza autorizzato da SAMMIC. **Si potrebbero verificare esplosioni fatali.**

Confezionamento di liquidi:

Tutti i modelli "SU" sono dotati di un sistema per il rilevamento dell'evaporazione di liquido che si sta confezionando. Quando si produce l'evaporazione di un liquido, la pressione del vuoto smette di calare. In caso contrario il controllo elettronico arresta il processo di produzione del vuoto e si accende il simbolo . Ciò avviene per evitare che il liquido contamini la camera del vuoto e l'olio della pompa.

Il simbolo  rimane acceso fino all'avvio di un nuovo ciclo.

Nota: Alcune miscele che all'apparenza sembrano liquide ma sono state frullate con un mixer contengono aria trattenuta nel prodotto. In queste situazioni è possibile che il rivelatore non funzioni in maniera ottimale ed è



necessario premere il tasto  per



attivare una PAUSA o  per evitare che il liquido rovini l'olio.

Per confezionare i liquidi è necessario utilizzare l'accessorio che mantiene il sacchetto a una determinata inclinazione per evitare la fuoriuscita del liquido. Nel caso in cui si formino delle bolle durante il confezionamento, significa che è stato raggiunto il grado di saturazione. Il punto di saturazione è simile al punto di evaporazione-ebollizione che si verifica a varie temperature in funzione della pressione.

Il punto di saturazione viene raggiunto tanto prima quanto maggiore è la temperatura del liquido durante l'elaborazione del vuoto. Si raccomanda innanzitutto di lasciar raffreddare il liquido prima di confezionarlo per ottenere il vuoto ottimale del prodotto.

Si indica una tabella relativa al punto di saturazione dell'acqua con il rapporto tra la temperatura e la pressione. In questo modo si indica approssimativamente il MASSIMO VUOTO che è possibile fare per ogni temperatura indicata del prodotto.

Pressione vuoto (mbar)	1000	100	50	31,67	20	10	6,09	5	2
Pressione vuoto (%)	0	90,1	95	96,87	98	99	99,4	99,5	99,8
Temp. Evaporazione (°C)	100	45	33	25	18	7	0	-2	-13

Asciugatura dell'olio:

Dopo aver lavorato con liquidi, a fine giornata è opportuno effettuare un ciclo di asciugatura dell'olio per eliminare l'umidità contenuta nella pompa e mantenerla nelle condizioni ottimali per realizzare il vuoto massimo. A tale fine si deve selezionare il programma  come indicato nel paragrafo "FUNZIONAMENTO"

Arresto automatico della pompa:

Nei modelli con funzionamento continuo della pompa, se la macchina NON viene utilizzata per 10 min la pompa si arresta automaticamente. Ciò impedisce un surriscaldamento dell'olio, riducendo il quantitativo di olio depositato nei filtri di espulsione e risparmiando energia. Chiudendo il coperchio, la pompa e il ciclo partono contemporaneamente.

-È importante pulire tutti i giorni l'interno e i bordi della camera, oltre che la guarnizione della chiusura.

-L'esterno della macchina non deve essere pulito con un getto d'acqua diretto. Utilizzare un panno umido e un detergente tradizionale.

Non pulire mai il coperchio con alcol, solventi, o prodotti per la pulizia dei vetri, perché si possono danneggiare le proprietà meccaniche del materiale provocandone la rottura. Se si nota un'incrinatura nel coperchio, interrompere l'utilizzo della macchina e rivolgersi al servizio tecnico autorizzato per la riparazione, poiché esiste il rischio di rottura del coperchio.

- Se il cavo di alimentazione è deteriorato ed è necessario installarne uno nuovo, la sostituzione potrà essere realizzata esclusivamente dal servizio tecnico autorizzato di SAMMIC.
- Prima di effettuare le operazioni di pulizia, revisione o riparazione della macchina, è obbligatorio scollegarla dalla rete elettrica.
- Il livello di rumorosità della macchina in funzione, installata a 1,6 m di altezza e 1 m di distanza, è inferiore a 75 dB (A). Rumore di fondo: 32 dB (A).

Cambio dell'olio

È necessario controllare ogni settimana il livello dell'olio, che deve coprire 3/4 dell'apertura. Se necessario, rabboccarlo.

Bisogna cambiare l'olio dopo le prime 100 ore di

funzionamento. In seguito cambiare l'olio:

- Modelli da appoggio; numero di modello 2: 150 ore
- Modelli a stativo; pompa funzionamento intermittente, numero di modello 1: 300 ore
- Modelli a stativo; pompa funzionamento continuo, numero di modello 0: 300 ore
- Quando la pompa ha funzionato le ore indicate, accendendo la macchina il display indicherà le ore e il simbolo  si accende per avvisare che è necessario cambiare l'olio.
- Bisogna cambiare l'olio anche qualora si noti che è emulsionato. La quantità di ore di lavoro accumulate può essere visualizzata all'accensione della macchina. Per eseguire il cambio, aprire il tappo di svuotamento e lasciare uscire l'olio usato. Per il riempimento, seguire le istruzioni fornite nel paragrafo corrispondente.
- Nelle pompe da 40m³/h e superiori, bisogna sostituire contemporaneamente anche il filtro dell'olio. Il filtro è del tipo utilizzato sulle automobili con il riferimento: AWS2, filettatura 3/4.
- Bisogna sostituire il filtro di scarico ogni 4

cambi d'olio oppure qualora si notino perdite d'olio o nebbia d'olio nello scarico.

OSSERVAZIONI

Quando la macchina esegue il ciclo del vuoto e il sensore rileva che la pressione del vuoto non arriva al set point programmato, dopo un determinato tempo di attesa il ciclo si arresta e passa alla fase di decompressione.

Se durante la fase di decompressione il coperchio non si apre, trascorso un determinato tempo l'elettrovalvola di decompressione si disconnette per evitare danni alla medesima o alla piastra elettronica.

Altre indicazioni importanti:

- Questo apparecchio non è destinato all'uso da parte di persone (bambini compresi) le cui capacità fisiche, sensoriali o mentali sono ridotte o che non hanno esperienza o competenze, salvo se sono sottoposte alla supervisione o alle istruzioni relative all'uso dell'apparecchio di un responsabile della sicurezza.
- I bambini devono essere controllati per essere sicuri che non giochino con l'apparecchio.
- Pulizia del coperchio

Precauzione!

Non pulire mai il coperchio con alcol, solventi o prodotti per pulire i vetri, giacché possono intaccare le proprietà meccaniche del materiale e provocarne la rottura. Per la loro pulizia utilizzare acqua e sapone. Qualora si riscontrasse una screpolatura sul coperchio, smettere di lavorare con la macchina e avvisare il servizio tecnico autorizzato per la sua riparazione, poiché vi è rischio di rottura dello stesso.

- Olio della pompa

Attenzione!

La pompa a vuoto contiene olio. Non inclinare la macchina

NOZIONI BASILARI PER IL CONFEZIONAMENTO SOTTOVUOTO

Il sottovuoto è un sistema di conservazione naturale che consiste nell'estrazione dell'aria dall'interno del sacchetto eliminando l'ossigeno, cioè il principale fattore che causa la decomposizione dei cibi.

Vantaggi del confezionamento sottovuoto

- 1- Riduce al massimo la perdita di peso dei prodotti.
- 2- Permette di approfittare dei tempi morti che si possono verificare nel corso della settimana per anticipare alcune attività e quindi di alleggerire il flusso di lavoro in cucina.
- 3- Si razionalizza lo stoccaggio dei prodotti nei frigoriferi:
 - Gli odori non si mescolano.
 - I prodotti sono etichettati, il che permette la rotazione delle materie prime.
 - Migliora il controllo dello stock, dato che si possono calcolare con precisione gli acquisti necessari.
- 4- Possibilità di approfittare delle offerte:
 - Permette di fare gli acquisti quando i prezzi sono più convenienti.
 - Riduzione degli spostamenti necessari.
- 5- Riduce la necessità di lavaggio degli utensili.

Confezionamento di prodotti stagionati (salumi, prosciutti, ecc.)

Trattandosi di prodotti che di per sé si conservano a lungo, con il confezionamento sottovuoto si duplica, come minimo, la durata di questi prodotti evitando che si seccino e che perdano peso con il conseguente danno economico. Non è necessario confezionare questi prodotti con il gas, salvo alcuni prodotti dalla struttura fragile.

Confezionamento di cibi cotti

Questo è il caso di prodotti come arrostiti, stufati, cannelloni, ecc. Una volta cotti, è indispensabile raffreddare il nucleo dei cibi da +65° C a +10° C in meno di due ore per impedire lo sviluppo di microrganismi.

Questo è il metodo più pratico per la conservazione dei prodotti della cucina tradizionale con i seguenti vantaggi:

- Facilitare l'elaborazione del prodotto senza correre il rischio che vada a male.
- Allungare la durata del prodotto.

Cottura dei prodotti confezionati

Consiste nel sistemare un alimento in un recipiente a tenuta e resistente al calore. Estrarre l'aria dall'interno, sigillarlo e sottoporlo all'azione di una fonte di calore per cuocerlo.

La cottura si svolge a bassa temperatura (tra 65° C e 100° C) ottenendo un effetto di pastorizzazione. Questo sistema presenta molti vantaggi, ad esempio:

- Conserva le qualità nutritive.
- Conserva le condizioni igieniche riducendo la manipolazione dei cibi.
- Riduce le perdite di peso in cottura, evitando l'evaporazione e l'essiccazione.
- Razionalizza la pianificazione del lavoro: i piatti si possono elaborare e cucinare nei momenti liberi dal servizio, si anticipa il lavoro necessario per l'allestimento di grandi pranzi, ecc.
- Prolunga il periodo di conservazione.

Dopo la cottura, il prodotto deve essere raffreddato rapidamente per arrestare il processo di cottura e per impedire lo sviluppo dei microrganismi. Questo processo si svolge con un apparecchio di raffreddamento rapido.

Piatti refrigerati: occorre abbassare la temperatura del nucleo del prodotto da +65° C a +10° C in meno di 2 ore.

Piatti surgelati: occorre abbassare la temperatura del nucleo del prodotto da +65° C a -18° C in meno di 4,5 ore.

Per lo stoccaggio successivo occorre mantenere una temperatura da 0° C a 3° C per i piatti refrigerati e di -18° C per quelli surgelati.

Per degustare al meglio gli alimenti, il processo di rigenerazione deve essere effettuato subito dopo l'estrazione dal frigorifero. Fondamentalmente, le tecniche di rigenerazione sono tre: il forno a vapore a bassa pressione, il bagnomaria e il forno a microonde. Nei primi due casi, la rigenerazione si svolge con il prodotto nella confezione stessa, mentre nel caso del microonde, è necessario perforare il sacchetto per fare fuoriuscire il vapore, oppure riscaldare il prodotto dopo averlo disimballato.

Se il prodotto rigenerato non viene consumato, non è possibile stoccarlo di nuovo e bisogna buttarlo via.

Il tempo di stoccaggio dei piatti refrigerati non deve superare i 6-21 giorni.

Confezionamento in atmosfera protettiva

Consiste nel sostituire l'aria che circonda il cibo con una miscela di gas con una proporzione diversa da quella dell'aria, con due obiettivi:

- Prolungare la durata del prodotto, senza che sia necessario l'impiego di additivi né di conservanti, inibendo processi di alterazione che si verificano durante lo stoccaggio.
- Evitare di schiacciare prodotti come dolci, insalate, ecc.

Si usano principalmente tre gas: O₂, CO₂ e N₂, o miscele degli stessi. In generale, una maggiore concentrazione di CO₂ (controllata) prolunga la durata del prodotto, mentre una certa quantità di N₂ evita la rottura della confezione dei prodotti con un elevato livello metabolico ed una piccola proporzione di O₂ assicura la conservazione in ottimo stato e il mantenimento dell'aspetto di alcuni alimenti.

Per la combinazione di gas più adatta a ciascun prodotto, si consiglia di consultare le ditte specializzate nei gas destinati all'alimentazione.

Surgelamento dei prodotti sottovuoto

Le tecniche di surgelamento tradizionali conservano il prodotto, ma non la qualità. Il surgelamento dei prodotti sottovuoto presenta molti vantaggi:

- Assenza di bruciature esterne
- Non c'è cristallizzazione superficiale
- Il gusto e l'aroma restano inalterati
- Non c'è essiccazione
- I grassi non si ossidano

Indicações para a marcação CE.

Cada máquina inclui os seguintes identificadores:

- Nome e morada do fabricante: SAMMIC, S.L. Basarte, 1, Azkoitia Gipuzkoa (ESPAÑA).
- Marca "CE".
- O modelo da máquina está indicado no seguinte ponto.
- O número de série está indicado na folha de garantia e na declaração de conformidade.

MODELOS

Este manual descreve a instalação, o funcionamento e a manutenção das embaladoras a vácuo controlado por sensor:

- modelos de bancada: SU-310, SU-316, SU-416, SU-420, SU-520
- modelos de chão: SU-604, SU-606, SU-806, SU-810.
- Modelos de chão de câmara dupla: SU-6000
- Opções para estes modelos:
 - Gás: « G » Sistema de injeção de gás
 - Impressora: « P » Placa eletrónica com bluetooth para a conectividade com o smartphone permitindo a criação de etiquetas adesivas
 - Soldadura « + »: Permite seleccionar o utilizador por meio de uma pulsação ter maior potência de soldadura para os sacos metálicos

A referência do modelo e as respectivas características vêm indicadas na placa de identificação colocada na máquina.

Estas embaladoras foram concebidas e fabricadas de acordo com as diretivas europeias 89 / 392 / CEE, 93 / 68 CEE, 73 / 23 / CEE e a normativa NSF de higiene e saneamento.

INSTALAÇÃO

Para obter as melhores prestações e manter a máquina em bom estado de conservação, deve-se seguir cuidadosamente as instruções contidas neste manual.

Local de instalação

Colocar a máquina de forma a ficar devidamente nivelada. Para evitar danos, nunca apoiar a máquina sobre um dos lados.

As máquinas de bancada devem ser instaladas sobre uma superfície lisa, dado que os pés são fabricados em material deslizante para poder mover a máquina sem esforço e limpar a superfície sobre a qual se apoia.

Ligação elétrica

1. Características da máquina

-As máquinas monofásicas estão previstas

para funcionar com tensão de 230V.

-As máquinas trifásicas estão previstas para tensões de 230V ou 400V (ligadas a 400V).

Antes de ligar a embaladora à rede elétrica, verificar se a máquina está preparada para a mesma voltagem que a da rede elétrica.

Para a mudança de voltagem (somente máquinas trifásicas):

1. Ligar os transformadores à tensão adequada, segundo a indicação no respetivo bloco de ligações.
2. Se necessário, mudar as conexões do motor tal como se indica na respetiva caixa de terminais.
3. Se necessário, ajustar o relé térmico tal como se indica no respetivo esquema elétrico.

2. Características do cabo

As embaladoras SAMMIC são fornecidas com um cabo elétrico de 1,5 m de comprimento, com revestimento termoplástico.

É OBRIGATÓRIA A LIGAÇÃO À TERRA. O fio de tomada de terra da máquina está assinalado.

Além disso, a máquina está equipada com um parafuso externo para a ligação a um sistema equipotencial de terra.



- Máquinas trifásicas: Preparar uma tomada de corrente mural com proteção magneto-térmica e diferencial de 3P+N+T de 20 A, e uma cavilha estanque para a ligar ao cabo de alimentação da embaladora.

- Máquinas monofásicas: Preparar uma tomada de corrente mural com proteção magneto-térmica e diferencial de 2P+T de 20 A. A cavilha que faz parte do cabo de alimentação deve estar acessível.

3. Mudança do sentido de rotação da bomba de vácuo (exclusivamente nas máquinas trifásicas)

Se ao efetuar o arranque da máquina for produzido um ruído anormal no motor da bomba de vácuo, tal deve-se ao facto de estar a rodar no sentido inverso. Nesse caso, parar imediatamente a máquina e trocar dois fios na alimentação.

Enchimento de óleo

Nos modelos SU-416, SU-420, SU-520, SU-600, SU-800, a bomba já contém óleo.

Nos modelos SU-310, SU-316, encher a bomba com óleo através da tomada, até completar $\frac{3}{4}$ do visor. Deve-se usar óleo sem detergentes:

-Óleo SAE10 (sem detergente) para as bombas até 20 m³/h.

-Óleo SAE30 (sem detergente) para as bombas superiores a 20 m³/h.

Recomenda-se que os óleos usados sejam parafínicos.

ENTRADA EM FUNCIONAMENTO

Uma vez acionado o interruptor geral, com o objetivo de aquecer o óleo e permitir um vácuo correto, é necessário realizar vários ciclos em vazio antes de proceder ao primeiro embalamento.



TECLA ON/OFF:  Tem 2 pilotos:

- Vermelho em espera com a máquina ligada à rede. A máquina está desligada em "OFF".

- Quando se prime passa a azul: máquina ligada "ON".

Se, durante algum tempo, não se utilizar a máquina, então passa automaticamente para espera OFF.

FUNCIONAMENTO:



TECLA:  Com cada pulsação, acede-se a:

-  PROGRAMAS de vácuo de 1 a 25: O número de programa ao qual se acede pisca



por meio das teclas

-  VÁCUO POR ETAPAS: Para produtos porosos, carnes processadas, misturas emulsionadas com ar preso, etc. Realiza-se 3 etapas até chegar ao vácuo de referência com um tempo de espera fixo em cada etapa:

Exp.: se o valor de referência for 99%:

Etapa 1: 91%, t = 10s

Etapa 2: 95%, t = 10s

Etapa 3: 97%, t = 10s

Termo: 99%



VÁCUO EXTERIOR (VÁC. NORM):

Para cubetas Gastronorm especiais para vácuo. Para poder utilizar esta função, é necessário adquirir o kit VAC-NORM, que inclui a mangueira e a adaptação à cuba da embaladora.

- Antes de ativar a função VAC-NORM, colocar o adaptador e a mangueira na aspiração da máquina.



- Colocar o outro extremo da mangueira na cubeta.



- Quando se prime a tecla,  arranca

a bomba que funciona até o vácuo alcançar, seja o de referência, depois, para e ativa a descompressão para libertar o tubo. Se se



premir  durante o vácuo, a bomba faz uma pausa e acende-se 

· **DRY OIL**, Secagem de óleo: Permite manter o óleo em boas condições reduzindo a humidade contida que permite alcançar o máximo vácuo da bomba. Baixa-se a tampa e a bomba funciona continuamente durante 15 min. A cada 2 min., ativa-se a válvula de entrada de ar, sem parar a bomba. No display central, aparece o tempo em minutos que falta para o final do ciclo.



· Premindo , também finaliza o processo em qualquer um dos modos de funcionamento indicados anteriormente. A fase do programa que se está a executar para e passa à seguinte.

PROGRAMAS DE VÁCUO:



· Prime-se  e prime-se 



ou  para seleccionar o número de programa de 1 a 25

· Prime-se sucessivamente as teclas do ciclo



e prime-se  ou  para escolher os valores



· **VÁCUO**: selecciona-se a percentagem de vácuo: 1% a 99%



· **VÁCUO +**: 1s – 15s só funciona se se tiver seleccionado o vácuo 99%



· **GÁS**: mostra a quantidade de gás que se introduz em %.

· Exp: ao seleccionar 20% de Gás e 99% de Vácuo, o display mostrará no ciclo a pressão final de vácuo 99% e depois introduz 20% de gás mostrando no display: 99% – 20% = 79%.

· Se a referência for 0%, então NÃO se introduz gás.



· **SOLDADURA**: tempo de selagem do saco: 0 – 7s



· **SOLDADURA +**: Se a máquina tiver este sistema (ver definições iniciais), para a



ativar basta manter a tecla  premida até se ativar o ícone. **Aumenta-se a potência de selagem** para sacos de tipo metálico.



· **ATMOSFERA PROGRESSIVA**: entrada de ar suave na câmara de 0 – 9s





· Prime-se  ou baixa-se a tampa para efetuar o ciclo que também ficará memorizado.

· Ao baixar a tampa, arranca o ciclo.

· **PAUSA VÁCUO**: Durante a fase de vácuo, se



se premir a tecla , a bomba para e aparece no display o símbolo , mantendo o vácuo. Ao premir novamente, arranca a bomba continuando o processo de vácuo.



· Se o bloqueio  ficar ativado, então NÃO se permitirá modificar os valores do programa de embalagem.

· Para desbloquear um programa,





prime-se  e premindo **OK** pisca 



e premindo  ou  selecciona-se ON/OFF. Para sair, prime-se

PROCESSO DE LIGAÇÃO E DEFINIÇÕES INICIAIS:

Nos primeiros 3 segundos, aparece o número de modelo no display central. Também se acende o símbolo , e, no display de 11 caracteres, vê-se o número de horas de funcionamento da bomba, para o controlo da mudança de óleo. Definições possíveis nos primeiros 3 segundos:

· **Número de modelo**: Premindo  mantido durante 2s. Define-se o número de

modelo, depois premir  ou  até mostrar o número de modelo:

Modelos equipados COM sistema de injeção de Gás:

· N.º “0”: Máquinas de chão, funcionamento contínuo: SU-600, SU-800, SU-6000. A bomba está a funcionar desde o momento em que se aciona o interruptor geral. Esta configuração está pensada para as máquinas que estão instaladas em lugares frios ou câmaras frigoríficas.

· N.º “1”: Máquinas de chão, funcionamento intermitente: SU-600, SU-800, SU-6000. A bomba está a funcionar durante a fase de vácuo e soldadura.

· N.º “2”: Máquinas de bancada, funcionamento intermitente: SU-300, SU-400, SU-500. A bomba está a funcionar apenas na fase de vácuo.

Modelos SEM sistema de injeção de Gás: Com o mesmo modo de funcionamento da bomba que os anteriores, configuram-se os mesmos modelos mas sem Gás.

· N.º “3”:

· N.º “4”:

· N.º “5”:

· **SOLDADURA + (Opcional)**: Se a máquina estiver equipada com este sistema, para cada número de modelo escolhido premindo a tecla



ativa-se o símbolo



· **Idioma e data**: Premindo  mantido durante 2s Define-se o idioma, a data, hora e temperatura:

1. IDIOMA



Pisca “Español” premir



ou  até escolher: “English”, “Français”, “Deutsch”, “Italiano”,



“Português” premir

2. DATA (Só modelos com placa bluetooth-impresora)

· Mostra data: dd/mm   e
· Pisca dd premir  ou  e para de piscar e passa para:

· mm premir  ou  

· aaaa premir  ou  

3. HORA



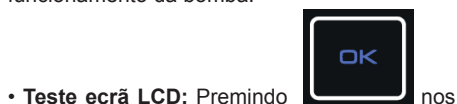

• **Horas Bomba:** Premindo  nos 3 primeiros seg. Faz-se um reset das horas de funcionamento da bomba.



• **Teste ecrã LCD:** Premindo  nos 3 primeiros seg. Faz-se um teste do ecrã LCD para verificar os segmentos do ecrã: acendem-se TODOS os símbolos durante 2s.

• **N.º Bluetooth (modelos opção impressora):**

Premindo  nos 3 primeiros seg., aparecerá o ícone  ativado e no display alfanumérico um número de 4 dígitos: "SU XXXX". Esse número deve coincidir com o número mostrado na aplicação (APP) do telemóvel.

• **Versão programa:** Premindo  nos 3 primeiros seg., aparece no display alfanumérico o número de versão do programa que utiliza a placa eletrónica.

Ao terminar cada definição, prime-se  para desligar a máquina, e liga-se novamente para aceder a outras definições ou ao funcionamento normal.

criação e impressão de etiquetas:

• Na aplicação desenvolvida para telemóvel-tablet, o utilizador escreve uma lista de até 50 produtos onde pode escrever:

- **Nome do estabelecimento:** "30 caracteres"
- **Produto:** "40 caracteres"
- **Data de Embalamento:** Exp. "10/11/2016" (Automático conforme a data da máquina)
- **Vácuo:** Exp. "99%" Gás: Exp. "20%" (Automático conforme o valor de vácuo e gás realizado pela máquina)

• **Temperatura Conservação:** em °C, °F conforme as definições na aplicação para impressão de etiquetas (APP)

• **Consumir antes de:** introduz-se os dias de validade e, na etiqueta, aparece a data de validade calculada a partir da data de embalamento

• O produto "0" visualiza-se no display como "ETIQUETAMANUAL" e só permite a impressão da etiqueta com os valores automáticos de "Data Embalamento" e "VÁCUO", o resto fica livre para escrever manualmente sobre a etiqueta.

DESCRIÇÃO APP PARA SMARTPHONE – TABLET

Carrega-se a aplicação num telemóvel ou tablet:

• Sistema Android: "Play Store"

• Sistema iPhone: "Apple Store"



1. Abrir a aplicação SAMMIC VACUUM 

TECLA: "IMPRESSÃO DE ETIQUETAS" (Só modelos equipados com placa bluetooth)



Ao premir a tecla , acede-se ao menu da impressão de etiquetas. Premindo

sucessivamente , acede-se a:



•  LISTA DE PRODUTOS premindo

 ou , no display, aparece o nome do produto, número de produto e o programa associado.



•  IMPRESSORA LIGADA: liga-se automaticamente quando se liga a impressora.

•  DIAS DE VALIDADE: premindo  ou , seleciona-se a validade em número de dias. Na etiqueta, aparecerá a data de validade resultante.

•  TEMPERATURA CONSERVAÇÃO:

premind  ou  seleciona-se a temperatura necessária para garantir a conservação do produto.

•  NÚMERO DE ETIQUETAS: premindo

 ou  seleciona-se o número de etiquetas que serão impressas em cada ciclo.

•  BLOQUEIO DO PROGRAMA: premindo

 ou  seleciona-se ON/OFF.

Se estiver ativado, bloqueia-se as teclas de programação do ciclo de vácuo, com o objetivo de garantir que não se alteram os parâmetros de embalamento.

• Para sair, premir novamente 

IMPRESSÃO DE ETIQUETAS:

• Colocar o rolo de etiquetas seguindo as instruções contidas no manual da impressora

• Ligar a impressora com o cabo fornecido.



• Ligar a impressora: Premir "POWER", o piloto "ON LINE" acende-se a vermelho, depois verde.



Ativa-se  Durante o ciclo de embalamento quando chega a fase de soldadura, imprime-se a etiqueta.

• Se se quiser imprimir mais de uma etiqueta durante o ciclo:

 Ao premir a tecla , acede-se ao menu da impressão de etiquetas. Premindo

sucessivamente , acede-se a:

a.  NÚMERO DE ETIQUETAS: premindo

 ou  seleciona-se o número de etiquetas que serão impressas em cada ciclo.

• **Etiqueta extra:** Finalizado um ciclo, premindo depois de abrir a tampa antes de 10s sem efetuar outro ciclo, imprime-se uma nova etiqueta.

• **Desligamento da impressora:** Premir e manter o botão "POWER" até o indicador "ON LINE" passar para vermelho e depois apagar-se



IMPRESSÃO DE ETIQUETAS: VAC-NORM

Depois de ter arrancado o vácuo, com a impressora ativada, quando se tiver alcançado o valor de vácuo de referência, para-se a bomba e imprime-se 1 etiqueta indicando o vácuo máximo alcançado.

CORTE DE SACO

As barras que incluem o fio para o corte de saco são fornecidas como kits.

A instalação é efetuada mudando a barra de soldadura pela barra que contém o fio de corte e mudando a ligação de um dos cabos no transformador de soldadura à tensão indicada no esquema elétrico:

Para realizar o corte do saco, basta programar o tempo adequado de soldadura na placa de controlo e, depois de soldar o saco, rasga-se manualmente pela linha marcada pelo fio de corte.

UTILIZAÇÃO E MANUTENÇÃO

- Muito importante: Não embalar produtos a quente, pois o vapor que produzem danifica a bomba de vácuo.
- **NUNCA** embalar produtos usando gás com um conteúdo em oxigénio superior a **20%** sem antes consultar o seu fornecedor ou serviço reconhecido pela SAMMIC. **Isto poderá causar explosões fatais.**

Embalamento de líquidos:

Todos os modelos "SU" estão equipados com um sistema para a deteção da evaporação de um líquido que se está a embalar. Quando ocorre a evaporação de um líquido, a pressão de vácuo deixa de diminuir e, se isto acontecer, o controlo eletrónico para o processo de vácuo e acende-se o símbolo . Isto faz-se para evitar que o líquido contamine a câmara de vácuo e o óleo da bomba.

O símbolo  permanece iluminado até começar um novo ciclo.

Nota: Determinadas misturas com aparência de líquido, mas batidas com uma misturadora, contêm ar preso na mistura. Nessas situações, é possível que o detetor não funcione otimamente e, por isso, é necessário premir a tecla



para fazer PAUSA ou  para evitar que o líquido possa estragar o óleo.



Para o embalamento de líquidos, deve-se usar o acessório que mantém o saco com uma inclinação para evitar a saída do líquido. Se aparecerem bolhas durante o embalamento significa que foi alcançado o ponto de saturação. O ponto de saturação é semelhante ao ponto de evaporação-ebulição que se produz a diferentes temperaturas em função da pressão. O ponto de saturação é alcançado antes quanto mais alta for a temperatura do líquido durante o processo de vácuo. **Recomenda-se arrefecer o líquido primeiramente antes de o embalar para obter o ótimo vácuo do produto.**

Indica-se uma tabela do ponto de saturação da água com a relação entre a temperatura e a pressão. Isto indica aproximadamente **MÁXIMO VÁCUO que se pode fazer para cada temperatura indicada do produto.**

Pressão vácuo (mbar)	1000	100	50	31,67	20	10	6,09	5	2
Pressão vácuo (%)	0	90,1	95	96,87	98	99	99,4	99,5	99,8
Temp. Evaporação (°C)	100	45	33	25	18	7	0	-2	-13

Secagem do óleo:

Depois de trabalhar com líquidos, é conveniente, no final de cada dia, fazer um ciclo de secagem do óleo que elimina a humidade contida na bomba e mantém a sua capacidade para fazer o máximo vácuo. Para isso, seleccionar o programa conforme indicado no ponto "FUNCIONAMENTO"

Paragem automática da bomba:

Nos modelos com funcionamento contínuo da bomba, se a máquina NÃO se utilizar durante 10 min, a bomba para automaticamente. Isto impede um sobreaquecimento do óleo, e reduz a quantidade de óleo depositada nos filtros de expulsão, além de poupar energia. Fechando a tampa, a bomba e o ciclo arrancam simultaneamente.

- É importante limpar diariamente o interior e rebordos da câmara, assim como a junta do fecho.
- O exterior da máquina não deve ser limpo com jacto directo de água. Utilizar um pano húmido e o detergente habitual. Nunca limpar a tampa com álcool, dissolventes ou produtos limpavidros, pois podem afetar as propriedades mecânicas do material e provocar a sua rutura. Caso se detete uma fissura na tampa, não continuar a trabalhar com a máquina e avisar o serviço técnico autorizado para a sua reparação, pois existe o risco de rutura

da tampa.

- Se o cabo de alimentação se deteriorar e for necessário instalar um novo, essa substituição só poderá ser realizada por um serviço técnico reconhecido pela SAMMIC.
- Antes de qualquer intervenção para a limpeza, revisão ou reparação da máquina, é obrigatório desligar a máquina da rede.
- O nível de ruído da máquina, em funcionamento, colocada a 1,6 m de altura e 1 m de distância é 75 dB (A). Ruído de fundo: 32 dB (A).

Mudança de óleo

É necessário controlar semanalmente o nível de óleo que deve cobrir 3/4 do visor de nível. Completar o enchimento, caso necessário.

O óleo deve ser trocado após as primeiras 100 horas de funcionamento. Posteriormente,

mudar o óleo:

- Modelos de bancada; número do modelo 2: 150 horas
- Modelos de fixação ao solo; bomba com funcionamento intermitente, número do modelo 1: 300 horas
- Modelos de fixação ao solo; bomba com funcionamento contínuo, número do modelo 0: 300 horas
- Quando a bomba tiver trabalhado as horas indicadas, ao ligar a máquina, o visor indicará as horas, e o símbolo  acende-se para avisar da mudança necessária do óleo.
- Também se deve mudar o óleo se se observar que está emulsionado. Pode-se visualizar a quantidade de horas de trabalho acumuladas ao ligar a máquina. Para efetuar a mudança, soltar o bujão de esvaziamento e deixar o óleo usado sair. Para encher, seguir as instruções dadas no respetivo ponto.
- Nas bombas de 40 m³/h e superiores, deve-se mudar simultaneamente o filtro de óleo. Este filtro é do tipo usado no automóvel conforme a referência: AWS2, rosca 3/4.
- O filtro de escape deve ser substituído a cada 4 mudanças de óleo ou quando se observar perdas de óleo ou névoa de óleo no escape.

OBSERVAÇÕES

Estando a máquina no ciclo de vácuo se o sensor detetar que a pressão de vácuo não

chega à referência programada, após um tempo de espera, o ciclo para passando à descompressão.

Se, ao fazer a descompressão a tampa não se abrir, depois de um tempo a eletroválvula de descompressão desliga-se para evitar danos na mesma ou na placa eletrónica.

Outras indicações importantes:

- Este aparelho não se destina a ser utilizado por pessoas (incluindo crianças) cujas capacidades físicas, sensoriais ou mentais são diminuídas, ou que têm falta de experiência ou conhecimentos, exceto sob supervisão, ou após receberem instruções sobre a utilização do aparelho, por uma pessoa responsável pela sua segurança.

- As crianças devem ser supervisionadas para garantir que não brincam com o aparelho.

-Limpendo a tampa

Atenção!

Nunca limpar a tampa com álcool, dissolventes ou produtos limpa-vidros porque pode afectar as propriedades mecânicas do material e provocar a sua ruptura. Para proceder à sua limpeza utilizar água e sabão. Se se detectar alguma fissura na tampa, não continuar a trabalhar com a máquina e avisar o serviço técnico autorizado para que proceda à sua reparação visto que existe perigo de ruptura da tampa.

-Óleo da bomba

Atenção:

A bomba de vácuo contém óleo.

Não incline a máquina.

NOÇÕES BÁSICAS SOBRE A EMBALAGEM EM VÁCUO

O vácuo é um sistema de conservação natural que consiste na extracção de ar do interior da bolsa eliminando o oxigénio, principal responsável pelo deterioro dos alimentos.

Vantagens da embalagem em vácuo

- 1-Reduz ao máximo a perda de qualidade dos produtos.
- 2-Rentabiliza as horas do pessoal ao aproveitar eventuais tempos mortos ao longo da semana, para adiantar o trabalho e aligeirar o fluxo de trabalho das cozinhas.
- 3-Racionaliza o armazenamento dos produtos nas câmaras:
 - Não há mistura de cheiros.
 - Os produtos são apresentados etiquetados o que permite a rotação de matérias- primas.
 - Melhora o controle dos stocks já que se pode calcular com precisão as compras necessárias para cada momento.
- 4-Aproveitamento dos melhores dias para a compra:
 - Permite comprar quando os preços são melhores.
 - Reduz-se a número de deslocações.
- 5-Reduz a lavagem de utensílios.

Embalagem de produtos curados (enchidos, presuntos, etc)

Tratado-se por si só de produtos com uma vida prolongada, a embalagem em vácuo duplica, no mínimo, a vida destes produtos evitando que se ressequem e que percam peso com o prejuízo económico que tal implica. Estes produtos não necessitam ser embalados com gás, excepto alguns produtos de textura frágil.

Embalagem de produtos cozinhados

Refere-se a produtos como os assados, estofados, canelones, etc. Uma vez cozinhados é indispensável arrefecer esses alimentos de +65°C a +10°C em menos de duas horas no centro do produto para impedir o desenvolvimento de microorganismos. Este é o método más prático para manter a cozinha tradicional com as seguintes vantagens:

- Facilitar o trabalho nas preparações sem necessidade de correr riscos de perda de qualidade do produto.
- Alongar a vida do produto.

Cozedura de produtos embalados

Consiste em colocar um alimento dentro de uma embalagem estanque e termoresistente. Extrair o ar do seu interior, selar e submeter à acção de uma fonte de calor para cozinhar o alimento. A cozedura realiza-se a baixa temperatura (entre 65°C e 100°C) conseguindo um efeito de pasteurização. Este sistema tem muitas vantagens:

- Preserva as qualidades nutricionais.
- Preserva as condições higiénicas ao diminuir a manipulação.
- Reduz as perdas de peso na cozedura ao evitar a evaporação e a dessecação.
- Racionaliza a planificação do trabalho: preparação e cozedura fora do período de serviço, antecipação da preparação de banquetes, etc.
- Prolonga o tempo de conservação.

Após a cozedura do produto, este deve ser arrefecido rapidamente para deter o processo de cozedura e impedir o desenvolvimento de microorganismos. Este processo é levado a cabo mediante um redutor de temperatura.

Pratos refrigerados: Deve-se reduzir a temperatura de +65°C a +10°C em menos de 2 horas no interior do produto.

Pratos congelados: Deve-se reduzir a temperatura de +65°C a -18°C em menos de 4,5 horas no interior do produto.

O posterior armazenamento deve manter-se a uma temperatura entre 0°C a 3°C para os pratos refrigerados e -18°C para os pratos congelados.

Para pôr os alimentos em condições de serem degustados, o processo de recuperação do produto deve processar-se de forma imediata depois de retirado do refrigerador no qual foi armazenado. Basicamente são três as técnicas de regeneração: o forno a vapor a baixa pressão, banho- maria e o forno microondas. Nos dois primeiros casos, a regeneração do produto faz-se com o material dentro da própria embalagem enquanto que no caso do microondas é necessário perfurar a bolsa para que o vapor possa escapar sem que a embalagem rebente ou então retirar totalmente o produto da embalagem.

Se um produto regenerado não chegar a ser consumido, não pode voltar a ser embalado devendo desfazer-se dele.

O tempo de armazenamento dos pratos refrigerados não deve exceder os 6-21 dias.

Congelação de produtos embalados em vácuo

As técnicas de congelação tradicionais conservam o produto mas não a qualidade. A congelação de produtos embalados em vácuo tem muitas vantagens:

- Não se queimam exteriormente
- Não há cristalização superficial
- Não há perda de sabor nem de cheiro
- Não há dessecação
- Não há oxidação de gorduras

SU-300

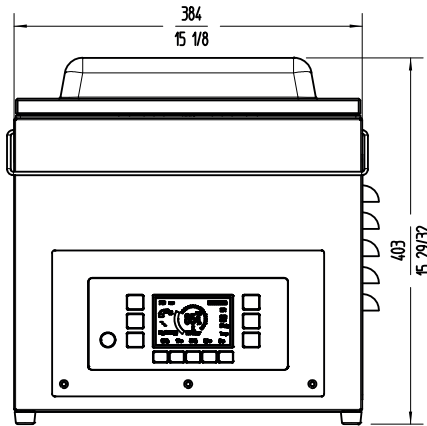
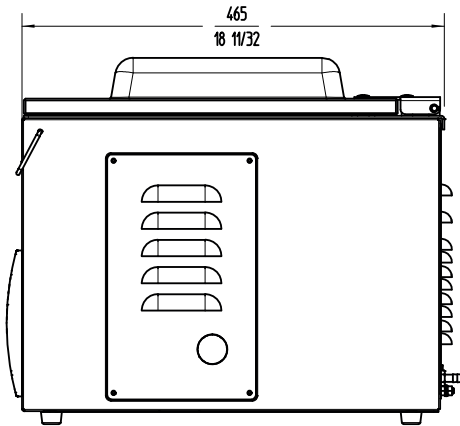

SU-420

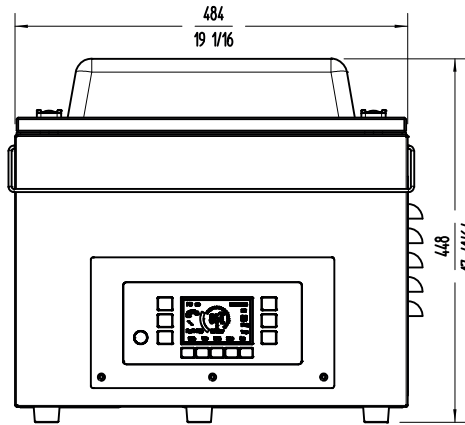
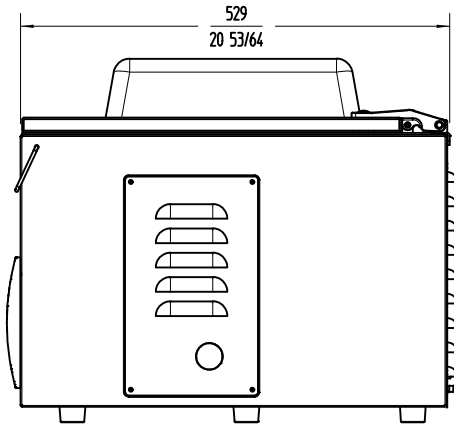

SU-520

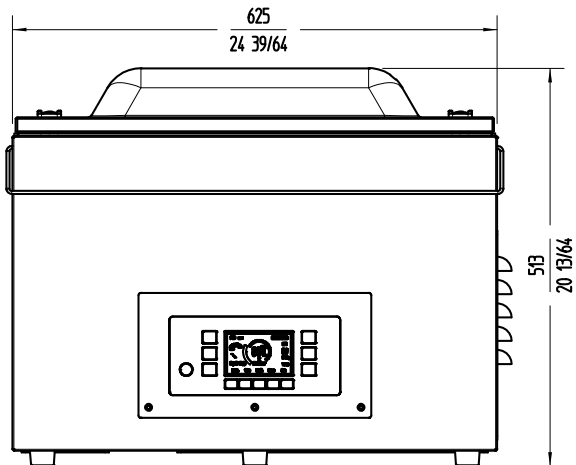
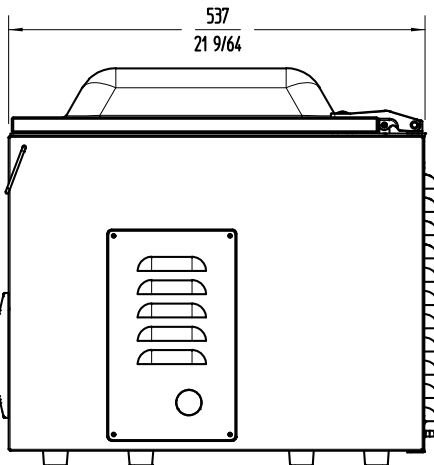

SU-600

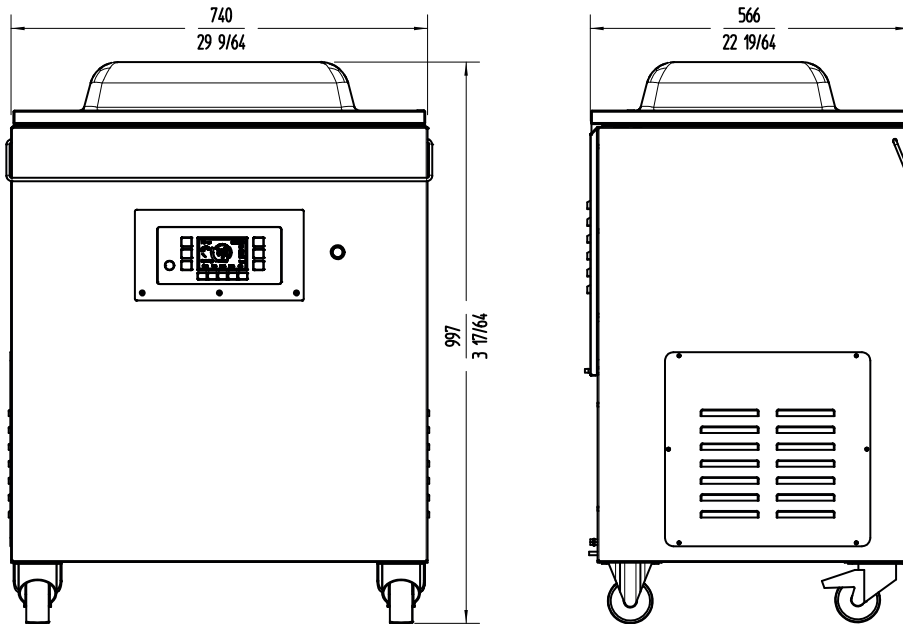

SU-800

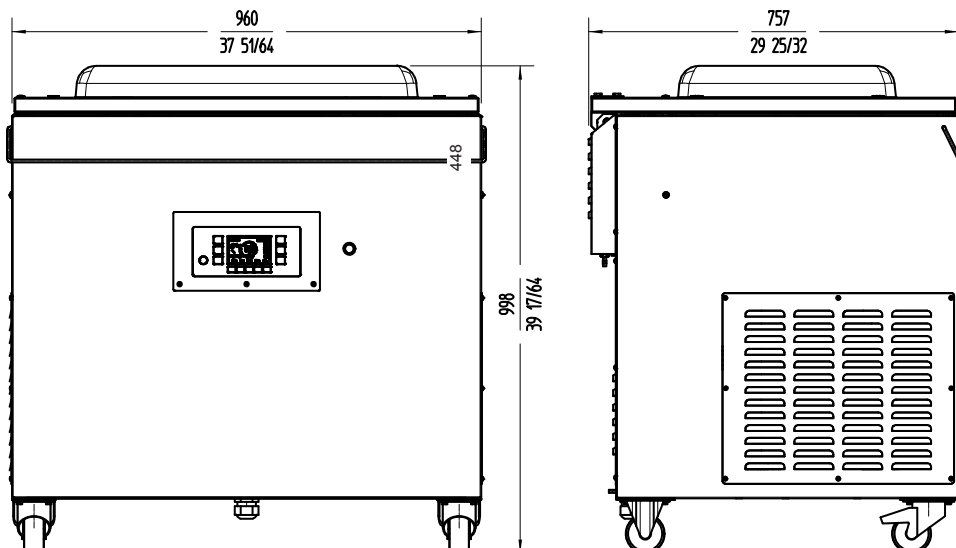

SU-6000

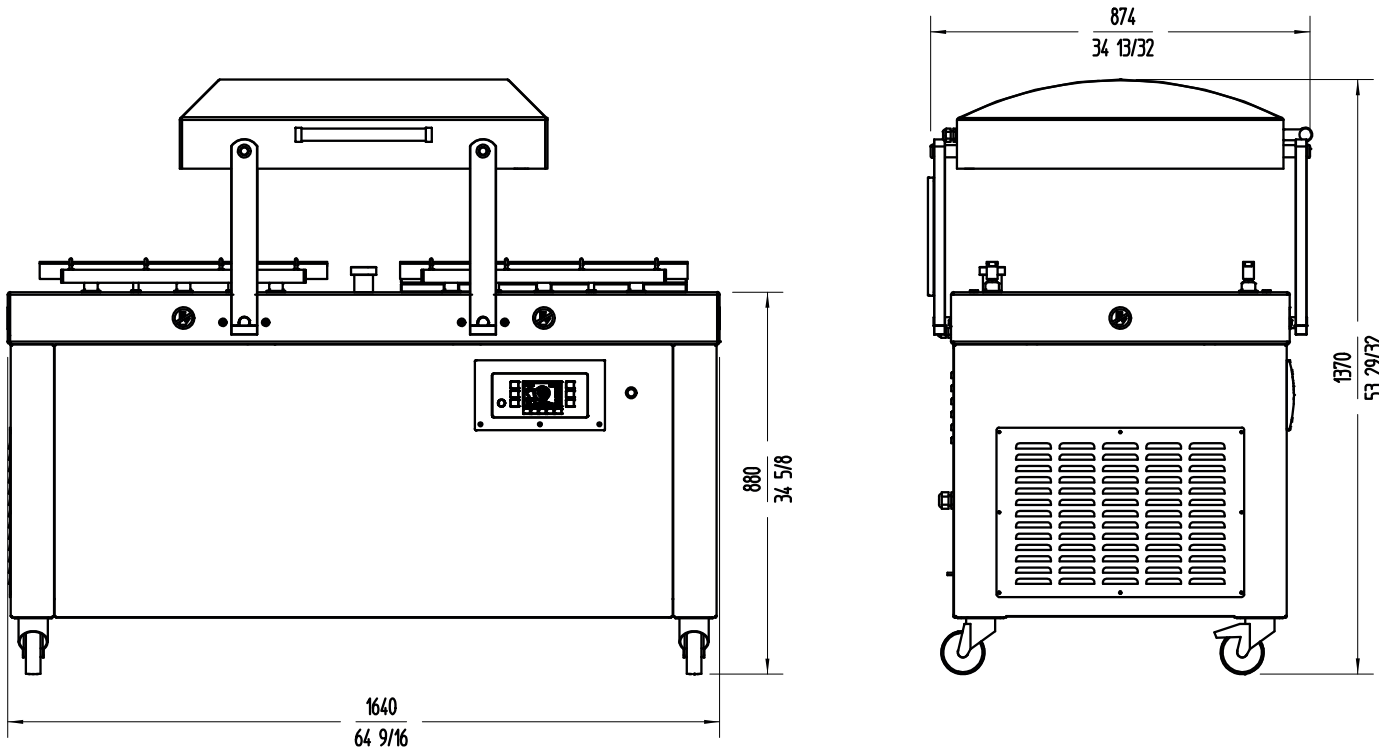

GAMA SENSOR ULTRA: SOBREMESA					
SENSOR ULTRA "SU"	SU-310	SU-316	SU-416	SU-420	SU-520
Capacidad Bomba (m3/h) (1)	10	16	16	20	20
Tipo de Soldadura	2 x 2,5 mm	2 x 2,5 mm	2 x 4,3 mm	2 x 4,3 mm	2 x 4,3 mm
Longitud barra soldadura (mm)	320	320	420	420	420 + 420
Alimentación eléctrica	230V/50-60Hz/1				
Potencia Bomba (kW)	0,37	0,55	0,55	0,75	0,75
Presión Vacío Máxima	2 hPa (mbar)	2 hPa (mbar)	2 hPa (mbar)	2 hPa (mbar)	2 hPa (mbar)
DIMENSIONES DE LA CÁMARA					
Ancho (mm)	330	330	430	430	560
Fondo (mm)	360	360	415	415	430
Alto (mm)	155	155	180	180	183
DIMENSIONES EXTERIORES					
Ancho (mm)	384	384	484	484	625
Fondo (mm)	465	465	529	529	537
Alto (mm)	403	403	448	448	513
PESO NETO (kg)	34	35	65	70	80

(1) BOMBAS BUSCH

GAMA SENSOR ULTRA: SUELO							
SENSOR ULTRA "SU"	SU-604 / 606	SU-604 CC / 606 CC	SU-806 / 810	SU-806 CC / 810 CC	SU-806 LL / 810 LL	SU-6000	SU-6160
Capacidad Bomba (m3/h) (1)	40 / 63	40 / 63	63 / 100	63 / 100	63 / 100	100	160
Tipo de Soldadura	2 x 4,3 mm	2 x 4,3 mm	2 x 4,3 mm	2 x 4,3 mm	2 x 4,3 mm	2 x 4,3 mm	2 x 4,3 mm
Longitud barra soldadura (mm)	413+656	465+465	530+848	581+581	848+848	660+660	660+660
Alimentación eléctrica	230-400V/50Hz/3N						
Potencia Bomba (kW)	1,1 / 1,5	1,1 / 1,5	1,5 / 2,2	1,5 / 2,2	1,5 / 2,2	2,2	4
Presión Vacío Máxima	0,5 hPa (mbar)	0,5 hPa (mbar)	0,5 hPa (mbar)	0,5 hPa (mbar)	0,5 hPa (mbar)	0,5 hPa (mbar)	0,5 hPa (mbar)
DIMENSIONES DE LA CÁMARA							
Ancho (mm)	672	672	864	864	864	662	662
Fondo (mm)	481	481	603	603	603	656	656
Alto (mm)	200	200	215	215	215	205	205
DIMENSIONES EXTERIORES							
Ancho (mm)	740	740	960	960	960	1640	1640
Fondo (mm)	566	566	757	757	757	874	874
Alto (mm)	997	997	998	998	998	1370	1370
PESO NETO (kg)	145 / 159	145 / 159	232 / 250	232 / 250	232 / 250	360	360

(1) BOMBAS BUSCH

SENSOR ULTRA MODELS: TABLETOP					
SENSOR ULTRA "SU"	SU-310	SU-316	SU-416	SU-420	SU-520
Vacuum pump (m3/h) (1)	10	16	16	20	20
Sealing type	2 x 2,5 mm	2 x 2,5 mm	2 x 4,3 mm	2 x 4,3 mm	2 x 4,3 mm
Sealing strip usable length (mm)	320	320	420	420	420 + 420
Electrical supply	230V/50-60Hz/1				
Pump loading (kW)	0,37	0,55	0,55	0,75	0,75
Vacuum pressure (maximum)	2 hPa (mbar)	2 hPa (mbar)	2 hPa (mbar)	2 hPa (mbar)	2 hPa (mbar)
CHAMBER DIMENSIONS					
- Width (mm)	330	330	430	430	560
- Depth (mm)	360	360	415	415	430
- Height (mm)	155	155	180	180	183
EXTERNAL DIMENSIONS					
- Width (mm)	384	384	484	484	625
- Depth (mm)	465	465	529	529	537
- Height (mm)	403	403	448	448	513
Net weight (kg)	34	35	65	70	80

(1) BUSCH PUMPS

SENSOR ULTRA MODELS: FREE-STANDING							
SENSOR ULTRA "SU"	SU-604 / 606	SU-604 CC / 606 CC	SU-806 / 810	SU-806 CC / 810 CC	SU-806 LL / 810 LL	SU-6000	SU-6160
Vacuum pump (m3/h) (1)	40 / 63	40 / 63	63 / 100	63 / 100	63 / 100	100	160
Sealing type	2 x 4,3 mm	2 x 4,3 mm	2 x 4,3 mm	2 x 4,3 mm	2 x 4,3 mm	2 x 4,3 mm	2 x 4,3 mm
Sealing strip usable length (mm)	413+656	465+465	530+848	581+581	848+848	660+660	660+660
Electrical supply	230-400V/50Hz/3N						
Pump loading (kW)	1,1 / 1,5	1,1 / 1,5	1,5 / 2,2	1,5 / 2,2	1,5 / 2,2	2,2	4
Vacuum pressure (maximum)	0,5 hPa (mbar)	0,5 hPa (mbar)	0,5 hPa (mbar)	0,5 hPa (mbar)	0,5 hPa (mbar)	0,5 hPa (mbar)	0,5 hPa (mbar)
CHAMBER DIMENSIONS							
- Width (mm)	672	672	864	864	864	662	662
- Depth (mm)	481	481	603	603	603	656	656
- Height (mm)	200	200	215	215	215	205	205
EXTERNAL DIMENSIONS							
- Width (mm)	740	740	960	960	960	1640	1640
- Depth (mm)	566	566	757	757	757	874	874
- Height (mm)	997	997	998	998	998	1370	1370
Net weight (kg)	145 / 159	145 / 159	232 / 250	232 / 250	232 / 250	360	360

(1) BUSCH PUMPS

MODÈLES SENSOR ULTRA: SUR TABLE					
SENSOR ULTRA "SU"	SU-310	SU-316	SU-416	SU-420	SU-520
Capacité pompe (m3/h) (1)	10	16	16	20	20
Soudure	2 x 2,5 mm	2 x 2,5 mm	2 x 4,3 mm	2 x 4,3 mm	2 x 4,3 mm
Longueur de soudure utile (mm)	320	320	420	420	420 + 420
Alimentation électrique	230V/50-60Hz/1				
Pompe puissance	0,37	0,55	0,55	0,75	0,75
Pression vide (max.)	2 hPa (mbar)	2 hPa (mbar)	2 hPa (mbar)	2 hPa (mbar)	2 hPa (mbar)
DIMENSIONS DE LA CHAMBRE					
- Largeur (mm)	330	330	430	430	560
- Profondeur (mm)	360	360	415	415	430
- Hauteur (mm)	155	155	180	180	183
DIMENSIONS EXTÉRIEURES					
- Largeur (mm)	384	384	484	484	625
- Profondeur (mm)	465	465	529	529	537
- Hauteur (mm)	403	403	448	448	513
Poids net (kg)	34	35	65	70	80

(1) POMPES BUSCH

MODÈLES SENSOR ULTRA: SUR PIED							
SENSOR ULTRA "SU"	SU-604 / 606	SU-604 CC / 606 CC	SU-806 / 810	SU-806 CC / 810 CC	SU-806 LL / 810 LL	SU-6000	SU-6160
Capacité pompe (m3/h) (1)	40 / 63	40 / 63	63 / 100	63 / 100	63 / 100	100	160
Soudure	2 x 4,3 mm	2 x 4,3 mm	2 x 4,3 mm	2 x 4,3 mm	2 x 4,3 mm	2 x 4,3 mm	2 x 4,3 mm
Longueur de soudure utile (mm)	413+656	465+465	530+848	581+581	848+848	660+660	660+660
Alimentation électrique	230-400V/50Hz/3N						
Pompe puissance	1,1 / 1,5	1,1 / 1,5	1,5 / 2,2	1,5 / 2,2	1,5 / 2,2	2,2	4
Pression vide (max.)	0,5 hPa (mbar)	0,5 hPa (mbar)	0,5 hPa (mbar)	0,5 hPa (mbar)	0,5 hPa (mbar)	0,5 hPa (mbar)	0,5 hPa (mbar)
DIMENSIONS DE LA CHAMBRE							
- Largeur (mm)	672	672	864	864	864	662	662
- Profondeur (mm)	481	481	603	603	603	656	656
- Hauteur (mm)	200	200	215	215	215	205	205
DIMENSIONS EXTÉRIEURES							
- Largeur (mm)	740	740	960	960	960	1640	1640
- Profondeur (mm)	566	566	757	757	757	874	874
- Hauteur (mm)	997	997	998	998	998	1370	1370
Poids net (kg)	145 / 159	145 / 159	232 / 250	232 / 250	232 / 250	360	360

(1) POMPES BUSCH

GAMMA SENSOR ULTRA: TABOLO					
SENSOR ULTRA "SU"	SU-310	SU-316	SU-416	SU-420	SU-520
Capacità Pompa (m3/h) (1)	10	16	16	20	20
Tipo di saldatura	2 x 2,5 mm	2 x 2,5 mm	2 x 4,3 mm	2 x 4,3 mm	2 x 4,3 mm
Lunghezza utile barra di saldatura (mm)	320	320	420	420	420 + 420
Alimentazione elettrica	230V/50-60Hz/1				
Potenza Pompa (kW)	0,37	0,55	0,55	0,75	0,75
Pressione vuoto Máxima	2 hPa (mbar)	2 hPa (mbar)	2 hPa (mbar)	2 hPa (mbar)	2 hPa (mbar)
DIMENSIONI CAMERA					
Larghezza (mm)	330	330	430	430	560
Profondità (mm)	360	360	415	415	430
Altezza (mm)	155	155	180	180	183
DIMENSIONI ESTERNE					
Larghezza (mm)	384	384	484	484	625
Profondità (mm)	465	465	529	529	537
Altezza (mm)	403	403	448	448	513
PESO NETTO (kg)	34	35	65	70	80

(1) BOMBAS BUSCH

GAMMA SENSOR ULTRA: SUOLO							
SENSOR ULTRA "SU"	SU-604 / 606	SU-604 CC / 606 CC	SU-806 / 810	SU-806 CC / 810 CC	SU-806 LL / 810 LL	SU-6000	SU-6160
Capacità Pompa (m3/h) (1)	40 / 63	40 / 63	63 / 100	63 / 100	63 / 100	100	160
Tipo di saldatura	2 x 4,3 mm	2 x 4,3 mm	2 x 4,3 mm	2 x 4,3 mm	2 x 4,3 mm	2 x 4,3 mm	2 x 4,3 mm
Lunghezza utile barra di saldatura (mm)	413+656	465+465	530+848	581+581	848+848	660+660	660+660
Alimentazione elettrica	230-400V/50Hz/3N						
Potenza Pompa (kW)	1,1 / 1,5	1,1 / 1,5	1,5 / 2,2	1,5 / 2,2	1,5 / 2,2	2,2	4
Pressione vuoto Máxima	0,5 hPa (mbar)	0,5 hPa (mbar)	0,5 hPa (mbar)	0,5 hPa (mbar)	0,5 hPa (mbar)	0,5 hPa (mbar)	0,5 hPa (mbar)
DIMENSIONI CAMERA							
Larghezza (mm)	672	672	864	864	864	662	662
Profondità (mm)	481	481	603	603	603	656	656
Altezza (mm)	200	200	215	215	215	205	205
DIMENSIONI ESTERNE							
Larghezza (mm)	740	740	960	960	960	1640	1640
Profondità (mm)	566	566	757	757	757	874	874
Altezza (mm)	997	997	998	998	998	1370	1370
PESO NETTO (kg)	145 / 159	145 / 159	232 / 250	232 / 250	232 / 250	360	360

(1) BOMBAS BUSCH



UNE-EN ISO 9001