

























Machine	Explode	Code	Description
Waring Xtreme Hi-Power Blender	Not shown	AC900	Stackable polycarbonate container with lid - 48oz
Waring Xtreme Hi-Power Blender	1	DM876	Jar lid cover
Waring Xtreme Hi-Power Blender	2		Jar lid
Waring Xtreme Hi-Power Blender	3		Jar only / 64 oz. Stackable Jar with blending assy. / 64 oz. Stackable
Waring Xtreme Hi-Power Blender	4	AE166	Blade assy.
Waring Xtreme Hi-Power Blender	5		Bearing holder o ring
Waring Xtreme Hi-Power Blender	6		Nut gasket
Waring Xtreme Hi-Power Blender	7		Bearing holder nut
Waring Xtreme Hi-Power Blender	8	AC930	Drive clutch
Waring Xtreme Hi-Power Blender	9		Jar pad
Waring Xtreme Hi-Power Blender	10		Jar pad/ sound enclosure
Waring Xtreme Hi-Power Blender	11	AC931	Motor
Waring Xtreme Hi-Power Blender	12	AC932	Dampening plate gasket
Waring Xtreme Hi-Power Blender	13		Top housing with ferrite core & cord (from 2013) Top housing / black (pre-2013)
Waring Xtreme Hi-Power Blender	14		Motor foam (2 req.'d)
Waring Xtreme Hi-Power Blender	15		Dampening plate bushing (4 req.'d)
Waring Xtreme Hi-Power Blender	16		Dampening plate sleeve (4 req.'d)
Waring Xtreme Hi-Power Blender	17		Washer (2 req.'d)
Waring Xtreme Hi-Power Blender	18		Screw (4 req.'d)
Waring Xtreme Hi-Power Blender	19	AC933	Control panel
Waring Xtreme Hi-Power Blender	20		Housing foam baffle / rear
Waring Xtreme Hi-Power Blender	21		Housing foam baffle / front
Waring Xtreme Hi-Power Blender	22		Motor housing
Waring Xtreme Hi-Power Blender	23		Washer (3 req.'d)
Waring Xtreme Hi-Power Blender	24		Bottom housing foam baffle
Waring Xtreme Hi-Power Blender	25		Foam baffle
Waring Xtreme Hi-Power Blender	26		Cable tie (3 req.'d)
Waring Xtreme Hi-Power Blender	27	AC934	Cord set (for older models pre-2013) For newer models, this is a component of part no. 13
Waring Xtreme Hi-Power Blender	28		Strain relief
Waring Xtreme Hi-Power Blender	29		Bottom housing / black
Waring Xtreme Hi-Power Blender	30	AC938	Screw (4 req.'d)
Waring Xtreme Hi-Power Blender	31		Corner post (4 req.'d)
Waring Xtreme Hi-Power Blender	32		Screw (4 req.'d)
Waring Xtreme Hi-Power Blender	032761		Spanner wrench (optional)
Waring Xtreme Hi-Power Blender	503351		Mx coupling wrench (optional)
Waring Xtreme Hi-Power Blender	030889	AE166	Blending assembly kit
Waring Xtreme Hi-Power Blender	033484	AE859	Brush/ spring (2 req.'d)
Waring Xtreme Hi-Power Blender	Not shown	AC929	Polycarbonate Jar with Blending Assembly - 48oz

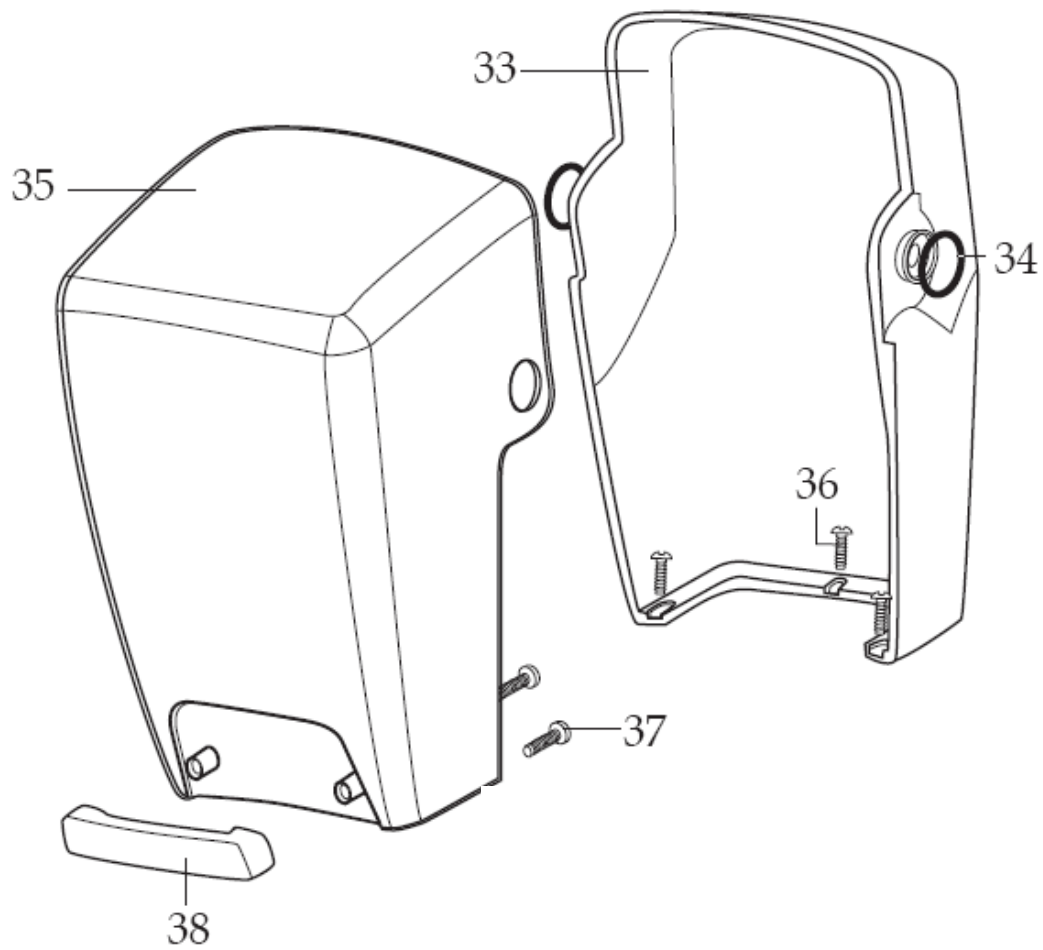

Waring Xtreme Hi-Power Blender	33		Inner sound enclosure / se1000
Waring Xtreme Hi-Power Blender	34		"O" ring 2 req.'d
Waring Xtreme Hi-Power Blender	35		Outer sound enclosure / se1000
Waring Xtreme Hi-Power Blender	36	AC937	Screw 3 req.'d
Waring Xtreme Hi-Power Blender	37	AC938	Screw 2 req.'d
Waring Xtreme Hi-Power Blender	38	AC939	Sound enclosure handle