

SHARP



Model

R-1900M

COMMERCIAL MICROWAVE OVEN OPERATION MANUAL

OPERATION MANUAL

This operation manual contains important information which you should read carefully before using your microwave oven.

IMPORTANT: There may be a serious risk to health if this operation manual is not followed or if the oven is modified so that it operates with the door open.

INTELLIGENT THINKING



C ONTENTS

Contents.....	1	Program & Customize.....	11
Important Safety Instructions.....	2	Custom Setting.....	11
Installation.....	2	Saving Memories.....	17
Troubleshooting.....	4	Other Convenient Features.....	21
Oven & Control Panel.....	6	Demonstration Mode.....	21
Before Operation.....	7	Monitor.....	21
How to Operate the Oven.....	7	Cleaning & Maintenance.....	22
Memory Operation.....	7	Cooking Advice.....	24
Memory Cooking.....	7	Suitable Cookware.....	24
Cooking double/triple quantity with		Food Handling & Preparation.....	26
memory.....	8	Advice for Defrosting.....	27
Express Defrost with Memory.....	9	Advice for Reheating.....	28
Manual Operation.....	9	Defrosting Chart.....	29
Time Cooking.....	9	Cooking Chart.....	31
Single Stage Cooking.....	9	Reheating Chart.....	34
Multi Stage Cooking.....	9	Caution.....	38
Repeat Cooking.....	10	To Replace the Mains Plug.....	39
Express Defrost.....	10	Calling for Service.....	39
		Specifications.....	40





I MPORTANT SAFETY INSTRUCTIONS

IMPORTANT: PLEASE READ CAREFULLY AND KEEP FOR FUTURE REFERENCE.

- The oven is for food preparation only.
Never operate when empty.
- Do not leave or store anything inside the oven when not in use.
- Never attempt to use the oven with the door open.
It is important not to tamper with the door safety latches.
This may result in exposure to microwave energy.
- Never operate the oven with any object caught in the door sealing surfaces, this again may cause microwave leakage.
- Do not insert fingers or objects in the holes of the door latches or air vent openings as this may damage the oven and cause an electric shock.
- If water or food drops inside the air vent openings switch off the oven immediately, unplug it and call a Service Technician appointed by SHARP.
- Never attempt to move the oven while it is operating.
- Do not use the oven near a steamer or a fryer.
- Always wipe up spills on the ceramic floor and splashes on the walls after cooking. If you leave grease on the ceramic floor and walls it may overheat, smoke or even catch fire when next using your oven.
- After each use wipe the splash cover on the ceiling of the oven with a soft damp cloth to remove any splashes.
If you leave grease on the splash cover it may overheat, smoke or even catch fire when next using your oven.

⚠ WARNING:

Children should be supervised to ensure that they do not play with the appliance.

Pacemaker: If you have a heart pacemaker, consult your doctor or the pacemaker manufacturer prior to oven use.

Fire: When heating food in plastic or paper containers, keep an eye on the oven due to the possibility of ignition.

If food overheats, starts to smoke or burn: Keep the oven door closed; turn the oven off; switch off the power at the socket and disconnect the plug from the socket. Failure to follow this procedure may result in fire and oven damage.

Liquids: Take care when microwaving liquids and beverages. To prevent delayed eruptive boiling of liquid and possible scalding: Stir liquid prior to and during heating/reheating, let liquid stand in the oven at the end of cooking.

Liquids and other foods must not be heated in sealed containers since they are liable to explode.

Eggs in their shell and whole hard-boiled eggs should not be heated in microwave ovens since they may explode even after microwave heating has ended. Refer to Cooking Advice.

Check the temperature of food and drink and stir (before serving). Take special care when serving food to babies, children or the elderly. The contents of feeding bottles and baby food jars should be stirred or shaken and the temperature checked before consumption to avoid burns.

For microwaving, use only those utensils suitable for microwave cookery refer to Suitable Cookware.

The oven should be cleaned regularly and any food deposits removed. Refer to Cleaning & Maintenance.

⚠ WARNING:

Only allow children to use the oven without supervision when adequate instruction has been given so that the child is able to use the oven in a safe way and understands the hazards of improper use.

This appliance is not intended for use by persons (including children) with reduced physical, sensory or mental capabilities or lack of experience and knowledge unless they have been given supervision or instruction concerning use of the appliance by a person responsible for their safety.

I NSTALLATION

⚠ WARNING:

**Inspect the Oven:
Check the oven carefully for damage before and regularly after installation.**

- Make sure the door closes properly, that it is not misaligned or warped.
- Check the hinges and door safety latches are not broken or loose.
- Ensure the door seal and sealing surfaces are not damaged.
- Inspect the oven interior and door for dents.

⚠ WARNING:

**Caution Sheet:
Always keep the caution sheet (Special Instructions and Warnings) close to the oven for your reference.**

**Important:
If any damage is apparent, do not operate the oven in any way. Contact your dealer or an authorised Service Technician appointed by SHARP.**

I NSTALLATION

1. Remove all packing materials. Remove the protective film (blue film) from the outer case cabinet (if covered). Do not remove the plastic film from the inside of the oven window as this protects it from dirt.
2. Place oven on a secure, level surface, strong enough to take the oven weight, plus the heaviest item likely to be cooked in the oven.
3. Ensure there is a minimum free space above the oven of 25 cm.
4. Do not place the oven where heat, moisture or high humidity are generated, (for example, near or above a conventional oven) or near combustible materials (for example, curtains). Do not block or obstruct air vent openings, as obstructions may ignite due to the emission of hot air.
5. Make sure the power supply cord is undamaged (See Installation next page) and that it does not run under the oven or over any hot or sharp surfaces.
6. The socket must be readily accessible so that it can be easily unplugged in an emergency.
7. Do not use the oven outdoors.
8. Two ovens can be installed together by placing one on top of another. Follow these instructions.
 - A. Place oven A in the desired location. Position Oven B on top of Oven A as shown in the figure.
 - B. Remove Screws (a) and Mounting plate A and B from the right side of the back of Oven A and B.
 - C. Replace Screws (a) removed at step B and tighten them.
 - D. Remove Screws (b), (c), (d), and (e) and then install Mounting Plate A and B which were removed at step B to the each lower edge of Oven B as shown in the figure.
 - E. Replace Screws (b), (c), (d), and (e) which were removed at step D and tighten them.

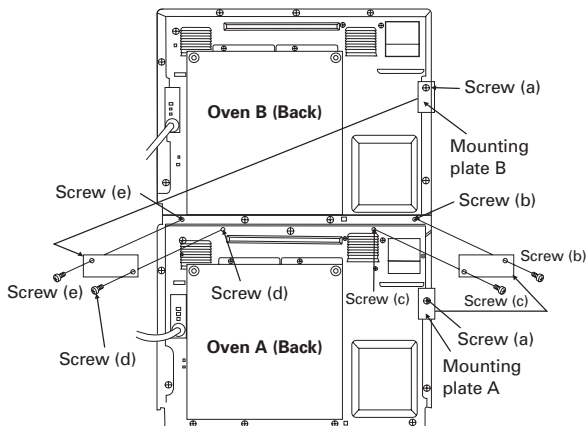

! WARNING:

In situations where two ovens are installed together by placing one on top of another,

- 1) Use the two mounting plates for fixing the two ovens.
- 2) Make sure that the power supply cord is not caught between the two ovens.
- 3) Do not install more than one oven on top of another.
- 4) Do not lose the removed screws.

! WARNING:

It is hazardous for anyone other than a Service Technician, approved by SHARP to carry out any service or repair operation which involves the removal of a cover which gives protection against exposure to microwave energy.

IMPORTANT! ELECTRICAL CONNECTION

- Do not allow water to come into contact with the power supply cord or plug.
- Insert the plug properly into the socket as the plug may otherwise overheat and catch fire.
- Do not connect other appliances to the same socket using an adaptor plug as it may cause the wiring to overheat and catch fire.
- If the plug or socket is loose or the power supply cord is damaged, do not operate the oven, it must be replaced by the special power cord. Contact your dealer or a Service Technician appointed by SHARP.
A defective plug, power supply cord or socket may overheat and catch fire during operation or cause an electrical shock.
- When removing the plug from the socket always grip the plug, never the mains lead as this may damage the power supply cord and the connections inside the plug.
- The product is fitted with a non-rewireable (moulded) plug. Should it not be suitable for the socket outlet in your kitchen, remove the plug and fit an appropriate type, observing the wiring code given in "To replace the mains plug" on page 39.

The fuse from a cut-off plug should be removed and the plug disposed of in safe manner. Under no circumstances should the cut-off plug be inserted into a socket outlet as serious electrical shock may occur. The plug must not be used without the fuse cover fitted.

When replacing the plug please ensure that you use a BSI or ASTA approved plug to BS1363, this should be fitted with a brown coloured 13 amp fuse approved by BSI or ASTA to BS1362. If you have any doubt about electrical connection seek the help of a qualified electrician.

! WARNING:

THIS APPLIANCE MUST BE EARTHED.

To wire an appropriate plug, follow the wiring code given in "To replace the mains plug" on page 39.

Radio or TV Interference

Should there be any interference caused by the microwave oven to your radio or TV, check that the microwave oven is on a different electrical circuit, relocate the radio or TV as far away from the oven as feasible or check position and signal of receiving antenna.

TROUBLESHOOTING

If you think the oven is not working properly there are some simple checks which you can carry out yourself before you call for an engineer. This will help prevent unnecessary service calls if the fault is something simple.

Simply answer "YES" or "NO" to the following questions:

1. Plug the power cord into a three-pronged electric-outlet. (See page 5)

2. Open the door

A. Does the oven light come on? Yes _____ No

3. Place one cup of water (approx. 250ml) in a microwave-safe glass measuring cup in the oven and close the door securely. Oven lamp should go off if door is closed properly.

Set the oven for 30 seconds on 100% (HIGH). At this moment:

Press these pads:

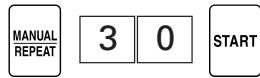

A. Does the oven light come on? Yes _____ No

B. Does the "ON" indicator come on? Yes _____ No

C. At the end of 30 seconds, is the water hot? Yes _____ No

IF SERVICE IS NEEDED, PLEASE CONTACT YOUR NEAREST AUTHORIZED SHARP SERVICER.

ERROR MODE

Should any of the error indicators appear in the display, follow the instructions:

EE Mode	Reason	Action Required
EE 1, EE 2	Failure of single magnetron	Call for service.★
EE 3	Both magnetrons failed	Call for service.
EE 4	Voltage too high	Call for service.
EE 5	Voltage too low	Call for service.
EE 7	Oven cavity or component temperature too high	Check that nothing is blocking air intake openings on oven back or that oven exterior is very hot. Correct. Wait a few minutes and try again. If problem persists, call for service.
EE 8	Circuit failure	Call for service.
EE 9	Maximum cooking time is exceeded.	Check NOTE for Cooking Double/Triple Quantity with Memory on page 8, NOTES 2 for Single Stage Cooking or NOTES 2 for Multi Stage Cooking on page 9 in the Operation Manual. Press the STOP/CLEAR pad, and re-input by reducing Total Cooking Time or power levels.
EE 0	Cooling fan motor or other motor failure. Splash cover is not installed properly.	Cooling fan motor and other motors: Call for service. Splash cover: Check that Splash cover is properly installed. If problem persists, call for service. (See page 22 - 23)

★ EE 1 and EE 2 : In case of single magnetron failure, oven can be used until servicing by changing Custom Setting, settings to allow operation under single magnetron only (see page 15). However, check food carefully as additional cooking time will be needed when operating with a single magnetron.

Press the STOP/CLEAR pad to clear the error indicator. Any time an error code appears, check the reason and be sure to call for service except EE7 and EE9. As for EE7, follow Action Required and if EE7 is still displayed, be sure to call for service.

If you answer "NO" to any question first check that the oven is plugged in properly and the fuse has not blown, if there is no fault with either, check against the troubleshooting chart below.

WARNING:

• **Never adjust, repair or modify the oven yourself, or allow anyone other than a Service Technician, appointed by SHARP to carry out the service.**

• The door seal stops microwave leakage during oven operation, but does not form an airtight seal. It is normal to see drops of water, light or feel warm air around the oven door. Food with a high moisture content will release steam and cause condensation inside the door which may drip from the oven.

• Repairs & Modifications: Do not attempt to operate the oven if it is not working properly.

• Outer Cabinet & Lamp Access: Never remove the outer cabinet. This would be very dangerous due to high voltage parts inside which must **never** be touched, as this could be fatal. As your oven has a removable cover over oven light bulb, it is possible for you to replace the light bulb yourself with care. The light bulb can be purchased from Sharp Electronics (U.K.) Ltd. See page 39. Unplug the oven before replacing the light bulb.



MAINTENANCE MODE

Should any of maintenance indicators appear in the display, follow the instruction:

CC Mode	Reason	Action required
CC1 CC2	Operation time of magnetrons exceeds 1,250 hours.	Call for service to replace the parts promptly. Failure to replace parts that have exceeded recommended operation time may cause failure of the microwave oven.
CC4	Operation time of the control unit, relays, switches exceeds 200,000 times.	
CC3	Operation time of exhaust motor exceeds 3,000 hours.	Even though CC3 is displayed, your oven can still be operated for short periods of time. Call for service to replace parts promptly.

NOTES:

1. The CC and " * " indicator will appear in the display when recommended parts life is exceeded. The CC and " * " indicator can be cleared by pressing the STOP/CLEAR pad. Call for service to replace the parts promptly. Failure to replace parts that have exceeded recommended operation time may cause failure of the microwave oven.
2. If one maintenance mode or more than one maintenance mode occurs at the same time, the display will show CC and the numbers of the modes separated by a period. For example, if CC1 occurs, the display will show CC and 1 reciprocally or if CC2 and CC4 occur at the same time, the display will show CC and 2.4. reciprocally.



OVEN & CONTROL PANEL

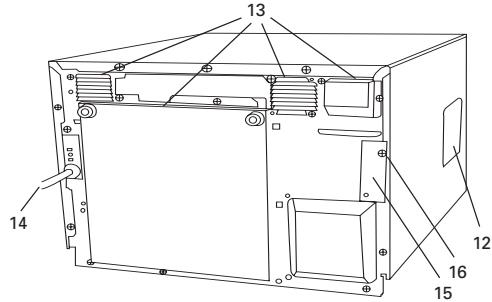
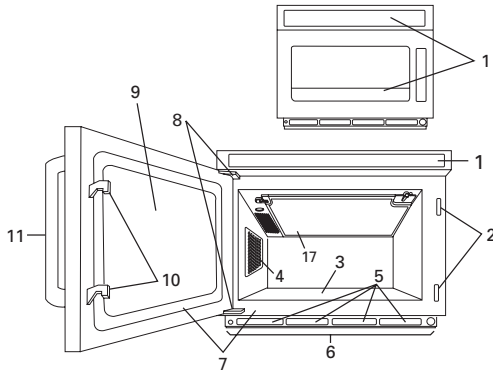

- | | |
|---|---|
| <ol style="list-style-type: none"> 1. Touch control panels 2. Door latch openings 3. Ceramic shelf 4. Oven light 5. Air intake openings 6. Air intake filter 7. Door seals and sealing surfaces 8. Door hinges 9. Oven door with see-through window 10. Door latches 11. Door handle | <ol style="list-style-type: none"> 12. Service window for replacing the oven light bulb 13. Ventilation openings 14. Power supply cord 15. Mounting plate 16. Screw for mounting plate 17. Splash cover |
|---|---|

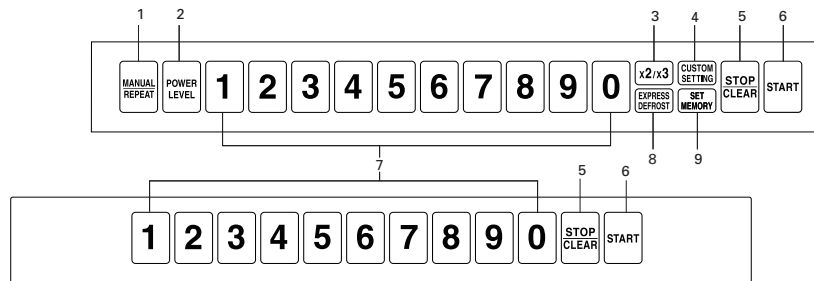

- | | |
|---|---|
| <ol style="list-style-type: none"> 1. MANUAL/REPEAT pad 2. POWER LEVEL pad 3. DOUBLE/TRIPLE QUANTITY pad 4. CUSTOM SETTING pad 5. STOP/CLEAR pad | <ol style="list-style-type: none"> 6. START pad 7. Ten number pads 8. EXPRESS DEFROST pad 9. SET MEMORY pad |
|---|---|

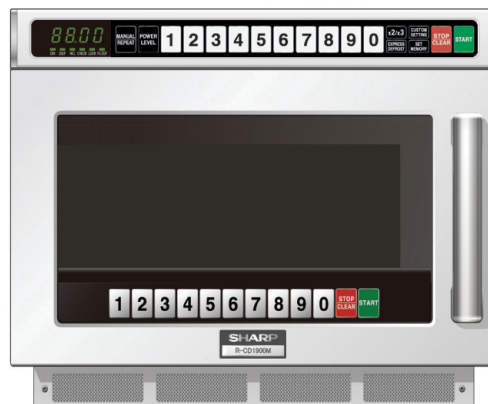
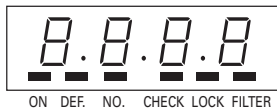

B EFORE OPERATION

- * Before operating your new oven, make sure you read and understand this operation manual completely.
- 1) Plug in the oven.
 - * The digital display will show “. “
- 2) Control panels can only be operated when the door is closed.
- 3) Oven light will go on for 1 minute whenever the door is opened or after cooking.

Cancellation:

1. Cooking data is canceled when keys are not pressed for more than three minutes when setting programming.
2. Cooking stops when the STOP/CLEAR pad is pressed and cooking data remains. However if subsequent keys are not pressed within three minutes, cooking data will be canceled. To resume cooking press the START pad.

3. Cooking stops when the door is opened and cooking data remains. However once the door is closed, cooking data will be canceled if subsequent keys are not pressed within 3 minutes. To resume cooking press the START pad.
4. Cooking is immediately canceled by pressing the STOP/CLEAR pad twice.

Checking food:

Press the STOP/CLEAR pad then open the door, check food, close the door and press the START pad to continue cooking.

Cooking Completion:

When food is not taken out after cooking completion, End will be shown in the display until the food is taken out.

HELPFUL TIPS for the Memory Input Method

The Memory Input Method determines how to input memory numbers for Memory Cooking and Custom Setting and Saving memories, therefore follow the method below. Refer to HELPFUL TIPS below as well as in Memory cooking.

1. **Dual Digit Input:** Must input two numbers to select a memory, even though the first number is 0. Memory programming is limited to 0 - 99.
2. **Single Digit Input:** Can only input one number to select a memory. Memory programming is limited to 0 - 9.
3. **Repeat Digit Input:** Input one, two, or three numbers to select a memory. Memory programming is limited to 0 - 29.
4. For Repeat Digit Input/Auto Start ON only, push number pads within one second of the previous number.
5. Regardless of Input Method selected, Counter Check/Clear (Custom Setting 7) and Multiplication Factor for Double/ Triple Quantity (Custom Setting 10) only use the Dual Digit Input Method. As for Custom Setting 10, enter memory number after pressing the DOUBLE/TRIPLE QUANTITY pad.

The Memory Input Method

Memory No.	0	2	12	22
Memory Examples				
Input Method				
Dual Digit Input	0, 0	0, 2	1, 2	2, 2
Single Digit Input	0	2		
Repeat Digit Input	0	2	2, 2	2, 2, 2

H OW TO OPERATE THE OVEN

MEMORY OPERATION

Memory Cooking

- * Your oven has 100 memory banks from 0 to 99. Memory contents from memory number 0 to 29 are same in Dual, Single and Repeat Digit Input methods.
- * Memory 0 - 9 are programmed as factory settings. See the table of Programmed Memories on the right side. Memory 10 - 99 must be programmed before using Memory Cooking. When a memory number which has not been programmed is entered, End will be shown in the display. See Saving Memories page 17 - 21 to program a new memory.

Programmed Memories

Memory No.	Cook time (sec.)	Output power
1	5	100%
2	10	100%
3	20	100%
4	30	100%
5	40	100%
6	50	100%
7	1 min.	100%
8	1 min. 15 sec.	100%
9	1 min. 30 sec.	100%
0	2 min.	100%



*** Memory Cooking can be set in 6 operating ways.**

There are multiple methods of selecting memories depending on the input method selected and whether or not Auto Start is turned on or off. To avoid mistakenly selecting the incorrect memory, please confirm your settings by checking Custom Setting (see Custom Setting 1 and 2 on page 11).

<6 operating ways>

1. Dual Digit Input/Auto Start OFF (memory 00 - 99)
2. Dual Digit Input/Auto Start ON (memory 00 - 99)
3. Repeat Digit Input/Auto Start OFF (memory 0 - 29)
4. Repeat Digit Input/Auto Start ON (memory 0 - 29)
5. Single Digit Input/Auto Start OFF (memory 0 - 9)
6. Single Digit Input/Auto Start ON (memory 0 - 9)

HELPFUL TIPS for the Display of Memory Input Status and the START pad

When Auto Start ON has been selected,

1. "0" should be displayed before entering memory number.
When "0" is not displayed, open the door and close to reset.
2. The START pad does not need to be pressed.
Cooking will automatically start when the memory number is input.

1. Dual Digit Input/Auto Start OFF (with the Start pad)

* Suppose you want to cook with memory 2, which was programmed for 10 seconds at 100%.

Procedure	
1 Place food in oven. Enter memory number.	<input style="width: 30px; height: 20px;" type="text" value="0"/> <input style="width: 30px; height: 20px;" type="text" value="2"/>
2 Press the START pad.	<input style="width: 30px; height: 30px; border: 1px solid black;" type="button" value="START"/>

2. Dual Digit Input/Auto Start ON (without the Start pad)

* Suppose you want to cook with memory 12, which was programmed for 10 seconds at 100%.

Procedure	
1 Place food in the oven. Enter memory number.	<input style="width: 30px; height: 20px;" type="text" value="1"/> <input style="width: 30px; height: 20px;" type="text" value="2"/>

3. Repeat Digit Input/Auto Start OFF (with the Start pad)

* Suppose you want to cook with memory 2, which was programmed for 10 seconds at 100%.

Procedure	
1 Place food in oven. Enter memory number.	<input style="width: 30px; height: 20px;" type="text" value="2"/>
2 Press the START pad.	<input style="width: 30px; height: 30px; border: 1px solid black;" type="button" value="START"/>

4. Repeat Digit Input/Auto Start ON (without the Start pad)

* Suppose you want to cook with memory 12, which was programmed for 10 seconds at 100%.

Procedure	
1 Place food in oven. Enter memory number.	<input style="width: 30px; height: 20px;" type="text" value="2"/> x 2

5. Single Digit Input/Auto Start OFF (with the Start pad)

* Suppose you want to cook with memory 2, which was programmed for 10 seconds at 100%.

Procedure	
1 Place food in oven. Enter memory number.	<input style="width: 30px; height: 20px;" type="text" value="2"/>
2 Press the START pad.	<input style="width: 30px; height: 30px; border: 1px solid black;" type="button" value="START"/>

6. Single Digit Input/Auto Start ON (without the Start pad)

* Suppose you want to cook with memory 2, which was programmed for 10 seconds at 100%.

Procedure	
1 Place food in oven. Enter memory number.	<input style="width: 30px; height: 20px;" type="text" value="2"/>

Cooking Double/Triple Quantity with Memory

Double/Triple Quantity is a feature where the oven will automatically calculate how to cook two or three servings of a programmed food. It does not simply double or triple the time. Factory setting is multiplication factor 1.8 for double quantity and 2.6 for triple quantity. Press the DOUBLE/TRIPLE QUANTITY pad once for Double Quantity (2 servings), and twice for Triple Quantity (3 servings).

* Suppose you want to cook 3 servings with memory number 2 programmed Single Digit Input/Auto Start ON.

Procedure	
1 Place food in oven. Press the DOUBLE/TRIPLE QUANTITY pad twice.	<input style="width: 30px; height: 20px;" type="text" value="x2/x3"/> x 2
2 Enter memory number.	<input style="width: 30px; height: 20px;" type="text" value="2"/>

NOTE : If your total cooking time is over the maximum time allowed, error message EE9 will be displayed. Press the STOP/CLEAR pad to clear the error message and reduce the quantity or cook without using Double/Triple Quantity. For details see Custom Setting 10 on page 15 and Maximum Cooking Time on page 21.

Express Defrost with Memory

* Suppose you want to cook with memory 0, which was programmed for 10 minutes Express Defrost sequence, Single Digit Input/Auto Start ON.

Procedure	
1 Place food in oven. Enter memory number.	0
Midway through the defrosting cycle, the CHECK indicator will light in the display and an audible signal will be heard unless signal volume has been set to Mute. You may open the door, turn food over and shield any warm portions. Close the door.	

Procedure	
2 Press the START pad to continue defrosting.	START

NOTES:

1. Even though CHECK lights up in the display, your oven continues defrosting and does not stop to check.
2. Press the START pad at step 2 to continue defrosting as once the door is closed, cooking data will be canceled if the START pad is not pressed within 3 minutes.
3. See HELPFUL TIP for Express Defrost on page 10.

MANUAL OPERATION

Time Cooking

Your oven can be programmed for up to 4 cooking sequences and has 11 preset microwave power levels.

Maximum Cooking Time



Microwave 100% - 60% Maximum of 60 minutes
 Microwave 50% - 10% Maximum of 120 minutes
 (Please see Maximum Cooking Time on page 21)

Microwave Power Level

Press the POWER LEVEL PAD once then press	APPROXIMATE PERCENTAGE OF POWER	Display
POWER LEVEL	100%	P-HI
9	90%	P-90
8	80%	P-80
7	70%	P-70
6	60%	P-60
5	50%	P-50
4	40%	P-40
3	30%	P-30
2	20%	P-20
1	10%	P-10
0	0%	P-0

Single Stage Cooking

* Suppose you want to cook for 2 minutes and 30 seconds at 50%.

Procedure	
1 Place food in oven and press the MANUAL/REPEAT pad. Enter cooking time.	 2 3 0
2 Press the POWER LEVEL pad and enter power level.	 5



Procedure	
3 Press the START pad.	START

NOTES:

1. It is not necessary to press the POWER LEVEL pad for 100% in Single Stage Cooking.
2. If cooking time input is over the maximum allowed time, error message EE9 will be displayed. Press the STOP/CLEAR pad to clear the error message and reduce cooking time or power level. For details, see Maximum Cooking Time on page 21.

Multi Stage Cooking

* Suppose you want to cook for 1 minute at 70% power for 1st stage and then continue to cook for 2 minutes at 50% power for 2nd stage and to cook for 3 minutes at 100% power for 3rd stage.

Procedure	
1 Place food in oven and press the MANUAL/REPEAT pad. Enter cooking time for 1st stage.	 1 0 0
2 Press the POWER LEVEL pad. Enter power level for 1st stage.	 7
3 Press the MANUAL/REPEAT pad. Enter cooking time for 2nd stage.	 2 0 0



Procedure	
4 Press the POWER LEVEL pad. Enter power level for 2nd stage.	POWER LEVEL 5
5 Press the MANUAL/REPEAT pad. Enter cooking time for 3rd stage.	MANUAL REPEAT 3 0 0
6 Press the START pad.	START

NOTES:

1. It is not necessary to press the POWER LEVEL pad for 100% at the last stage in Multi Stage Cooking.
2. If the Total Cooking Time is over the maximum time allowed, error message, EE9 will be displayed. Press the STOP/CLEAR pad to clear the error message pad and reduce Total Cooking Time, power levels or stages. For details, see Maximum Cooking Time on page 21.

Repeat Cooking

Use REPEAT COOKING to re-cook in the previous manual cooking setting. The previous manual cooking setting is memorized unless the oven is unplugged.

- * Suppose you want to re-cook in the previous manual cooking setting, 1 minute at 70% power for 1st stage and then continue to cook for 2 minutes at 50% power for 2nd stage and to cook for 3 minutes at 100% power for 3rd stage.

Procedure	
1 Place food in oven. Press the MANUAL/REPEAT pad.	MANUAL REPEAT
2 Press the START pad.	START

Express Defrost

Use EXPRESS DEFROST to defrost meat and poultry. Calculate total defrost time using chart below. Express Defrost can be programmed for a maximum of 90 minutes.

- * Suppose you want to defrost one pound of lamb chops for 3 minutes and 30 seconds.

Procedure	
1 Place food in oven. Press the EXPRESS DEFROST pad.	EXPRESS DEFROST
2 Enter defrosting time. (Refer to chart below.)	3 3 0
3 Press the START pad.	START
Midway through the defrosting cycle, the CHECK indicator will light in the display and an audible signal will be heard unless signal volume has been set to Mute. You may open the door, turn food over and shield any warm portions. Close the door.	
4 Press the START pad to continue defrosting.	START

NOTES:

1. Even though CHECK lights up the display, your oven continues defrosting and does not stop to check.
2. Press the START pad at step 4 to continue defrosting. Once the door is closed, cooking data will be canceled if subsequent keys are not pressed within 3 minutes.

HELPFUL TIP for Express Defrost

Allow foods to stand a few minutes after defrosting to equalize the temperature for better cooking results. Check food after standing. If additional time is needed, continue to defrost with manual cooking. Foods that are the same thickness throughout defrost better. If foods have varied thickness, it may be necessary to shield the thin edges with small flat pieces of aluminum foil to prevent overdefrosting.

PROGRAM & CUSTOMIZE

Custom Setting

You can check your oven settings and customize your oven by changing Custom Setting settings.

The CUSTOM SETTING pad has 11 operations.

1. Selecting Memory Input Method
2. Selecting Auto Start Operation
3. Program Lock Setting
4. Audible Signal Sound Volume Setting
5. Cooking Completion Signal Setting
6. Memory Check
7. Counter Check/Clear
8. Air Intake Filter Counter
9. Selecting Operation in case of Magnetron Failure
10. Multiplication Factors for Double/Triple Quantity
11. Express Defrost Setting

To use Custom Setting Function, press the CUSTOM SETTING pad twice within 2 seconds, and desired option pads. See detailed instructions below.

NOTE : You will hear an audible signal the second time the CUSTOM SETTING pad is pressed to indicate that you have entered Custom Setting.

1. Selecting Memory Input Method

Your oven has 3 ways to select memory numbers.

- CH11 : Dual Digit Input (100 memory banks)
= Factory Setting
- CH12 : Single Digit Input (10 memory banks)
- CH13 : Repeat Digit Input (30 memory banks)





To set Input Method

Press the CUSTOM SETTING pad twice within 2 seconds then enter the numbers

- 1,1 for Dual Digit Input
- 1,2 for Single Digit Input
- 1,3 for Repeat Digit Input

Press the START pad to save settings and the STOP/CLEAR pad to exit from the Custom Setting Function.

* Suppose you want to set Repeat Digit Input.

Procedure	
 x 2	1 Press the CUSTOM SETTING pad twice within 2 seconds.
	2 Enter 1,3 for Repeat Digit Input.
	3 Press the START pad to save the setting.
	4 Press the STOP/CLEAR pad to exit from the Custom Setting Function.

2. Selecting Auto Start Operation

Your oven has 2 ways to start memory cooking.

- CH21 : Auto Start OFF = Factory Setting
- CH22 : Auto Start ON

The factory setting is Auto Start OFF. Under Auto Start OFF, cooking will not begin until the START pad is pressed. Under Auto Start ON, cooking will automatically start after the memory number is input.





To set AUTO START

Press the CUSTOM SETTING pad twice within 2 seconds then enter the numbers

- 2, 1 for Auto Start OFF
- 2, 2 for Auto Start ON

Press the START pad to save settings and the STOP/CLEAR pad to exit from the Custom Setting Function.

* Suppose you want to set Auto Start ON.

Procedure	
 x 2	1 Press the CUSTOM SETTING pad twice within 2 seconds.
	2 Enter 2, 2 for Auto Start ON.
	3 Press the START pad to save the setting.
	4 Press the STOP/CLEAR pad to exit from the Custom Setting Function.

3. Program Lock Setting

You can select Program Lock ON or OFF

- CH31 : Program Lock OFF = Factory Setting
- CH32 : Program Lock ON

Program Lock OFF is the Factory setting. Program Lock prevents accidental changes to settings. When the CUSTOM SETTING pad is pressed twice within 2 seconds in program Lock ON, the LOCK indicator will light up. Turn Program Lock OFF when you want to change the settings.





To turn Program Lock ON/OFF

Press the CUSTOM SETTING pad twice within 2 seconds then enter the numbers

- 3, 1 for Program Lock OFF
- 3, 2 for Program Lock ON

Press the START pad to save settings and the STOP/CLEAR pad to exit from the Custom Setting Function.

* Suppose you want to set Program Lock ON.

Procedure	
 x 2	1 Press the Custom Setting pad twice within 2 seconds.
 	2 Enter 3, 2 for Program Lock ON.
	3 Press the START pad to save the setting.
	4 Press the STOP/CLEAR pad to exit from the Custom Setting Function.

NOTE : If you select Program Lock OFF, the LOCK indicator in the display will disappear when you press the START pad.

Operation when Program Lock ON is set

KEY Operation	Custom Setting Title	When Program Lock ON is set
1	Selecting Memory Input Method	no operation
2	Selecting Auto Start Operation	no operation
3	Program Lock Setting	operation
4	Audible Signal Sound Volume Setting	no operation
5	Cooking Completion Signal Setting	no operation
6	Memory Check	operation
7	Counter Check/Clear	check : operation clear : no operation
8	Air Intake Filter Counter	check, clear : operation set : no operation
9	Selecting Operation in case of Magnetron Failure	no operation
x2/x3	Multiplication Factors for Double/Triple Quantity	check : operation set : no operation
EXPRESS DEFROST	Express Defrost Setting	check : operation set : no operation

4. Audible Signal Sound Volume Setting

The volume of the audible signal can be adjusted to High, Medium, or Mute.

- CH41 : High = Factory Setting
- CH42 : Medium
- CH43 : Mute

To set cooking completion signal volume

Press the CUSTOM SETTING pad twice within 2 seconds then enter the numbers

- 4, 1 for High
- 4, 2 for Medium
- 4, 3 for Mute

Press the START pad to save setting and the STOP/CLEAR pad to exit from the Custom Setting Function.

NOTE : Even when errors occur, your oven will not beep in mute setting.

5. Cooking Completion Signal Setting

There is a choice of 4 different signals on your oven.

- CH51 : 1 long beep = Factory setting
- CH52 : Repeating long beeps
- CH53 : 4 short beeps
- CH54 : Repeating short beeps

To set the signal type

Press the CUSTOM SETTING pad twice within 2 seconds then enter the numbers



- 5, 1 for 1 long beep
- 5, 2 for repeating long beeps
- 5, 3 for 4 short beeps
- 5, 4 for repeating short beeps

Press the START pad to save settings and the STOP/CLEAR pad to exit from the Custom Setting Function.

6. Memory Check

Use this setting to check the programming for a certain memory.

* Suppose you want to know the information programmed into memory 1, programmed for 4 minutes at 60% for the 1st stage and 2 minutes at 30% at the 2nd stage programmed Dual Digit Input.

Procedure	Display
 x 2 	
1 Press the CUSTOM SETTING pad twice within 2 seconds and enter 6.	



Procedure	Display
0	
1	
2 Enter memory number.	After about 1 sec.
(After entering the memory number, the memory setting of each content is shown for 1.5 seconds at 0.3 second intervals until the STOP/CLEAR pad is pressed.)	
3 Press the STOP/CLEAR pad to exit from the Custom Setting Function.	

NOTES:

- If is displayed at step 2 the memory has not been programmed.
- Multiple memories can be checked until the STOP/CLEAR pad is pressed to exit from the Custom Setting Function.
- The way to enter memory numbers depends on the programmed Memory Input Method.
- When Express Defrost is set for 30 minutes in the memory, and are displayed repeatedly at step 2.

7. Counter Check/Clear

Confirm counters are set to "0" before using oven for the first time.

Counter Check

Counter check can be used to check the total number of times the oven has been used, or the number of times each pre-programmed memory pad, manual cooking, or Express Defrost has been used.

Total usage Press the CUSTOM SETTING pad twice within 2 seconds, then enter 7. Total usage will be displayed.

To check more than one counter

Press each pad as indicated below, after the previous usage is displayed.

- Total each memory usage** Input memory number.
- Total manual cooking usage** Press the MANUAL/REPEAT pad.
- Total Express Defrost usage** Press the EXPRESS DEFROST pad.

* Suppose you want to know total usage and each memory usage. In this case the oven was used 8268 times and memory 1 in any Memory Input Method was used 513 times.

Procedure	Display
x 2 7	After about 1 sec.
1 Press the CUSTOM SETTING pad twice within 2 seconds, then enter 7. Total usage will be displayed.	
0	
1	
2 Enter memory number 1, to check the total memory usage of memory 1.	After about 1 sec.





NOTES:

- To exit from Counter Check, press the STOP/CLEAR pad.
- Each counter will count up to 9999, and then will automatically reset to 0 and begin counting again.
- As shown in the above example, multiple counters can be checked before pressing the STOP/CLEAR pad to exit.
- Only Dual Digit Input Method can be used when inputting memory numbers in Counter Check/Clear.

To Reset the Counter to "0"

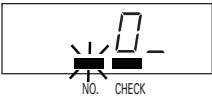
Each counter can be manually reset to "0" by pressing the START pad after the count is displayed.

- * Suppose you want to reset the count for memory number 1 in any Memory Input Method

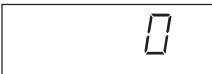
Procedure	
<p>CUSTOM SETTING x 2 7</p> <p>1 Press the CUSTOM SETTING pad twice within 2 seconds, then enter 7. Total usage will be displayed.</p>	<p>After about 1 sec.</p> 
<p>2 Enter memory number 1 to check the total memory usage of memory 1.</p> <p>0</p>  <p>1</p>  <p>After about 1 sec.</p> 	
<p>START</p> <p>3 Press the START pad.</p>	
<p>STOP CLEAR</p> <p>4 Press the STOP/CLEAR pad to exit from the Custom Setting Function.</p>	

NOTES:

1. Only Dual Digit Input method can be used when inputting memory numbers in Counter Check/Clear.
2. To clear total manual cooking usage, press the MANUAL/REPEAT pad in Step 2 instead of the number pad.
3. To clear total Express Defrost usage, press the EXPRESS DEFROST pad in Step 2 instead of the number pad.
4. To clear total usage, skip Step 2.



8. Air Intake Filter Counter

Use Custom Setting Function for Air Intake Filter Counter to check total usage hours since the Air Intake Filter was last reset to "0".

- CH81 : The total used air intake filter time appears.
- CH82 : The limit time for using a filter can be changed.

Use Custom Setting Function for Air Intake Filter Counter to change the Air Intake Filter cycle from 001-999. The factory setting is 100 hours. When 100 hours is exceeded, the FILTER indicator in the display will start to flash on and off as a reminder to clean the air filter, even if in the middle of cooking. Furthermore "FILT" flashes on and off in stead of displaying ". ." during standby and at the same time FILTER indicator flashes on and off. Clean Air Intake Filter (See page 22 - 23), when the FILTER indicator appears in the display, and then clear the total usage to reset it to "0" .





- * Suppose you want to know the total usage hours which has been 99 hours since the last reset.

Procedure	Display
<p>CUSTOM SETTING x 2 8 1</p> <p>1 Press the CUSTOM SETTING pad twice within 2 seconds and enter 8, 1.</p>	<p>After about 1 sec.</p>  
<p>STOP CLEAR</p> <p>2 Press the STOP/CLEAR pad to exit from the Custom Setting Function.</p>	

To Reset the Air Intake Filter Counter

Reset the Air Intake Filter Counter after cleaning the air intake filter.















- * Suppose you want to reset the air filter counter which has been 101 hours since the last reset and the Air Intake Filter cycle is preset to 100.

Procedure	Display
<p>CUSTOM SETTING x 2 8 1</p> <p>1 Press the CUSTOM SETTING pad twice within 2 seconds and enter 8,1.</p>	<p>After about 1 sec.</p>  
<p>START</p> <p>2 Press the START pad to reset the counter to "0".</p>	
<p>STOP CLEAR</p> <p>3 Press the STOP/CLEAR pad to exit from the Custom Setting Function.</p>	

Air Filter Cycle

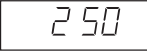
Air Filter Cycle can be changed from the factory setting of 100 hours to 001-999 hours

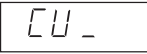
* Suppose you want to set the cycle to 250 hours.

Procedure	Display
 x 2  	 After about 1 sec. 
1 Press the CUSTOM SETTING pad twice within 2 seconds and enter 8, 2.	
	
2 Press the MANUAL/REPEAT pad.	
  	
3 Enter desired time. (Ex : Enter 2, 5, 0 for 250 hours).	
	
4 Press the START pad to save settings.	
	
5 Press the STOP/CLEAR pad to exit from the Custom Setting Function.	

9. Selecting Operation in case of Magnetron Failure

Your oven has 2 magnetrons. In case of single magnetron failure, the oven can be used until servicing by changing settings to allow operation under single magnetron only. However, check food carefully as additional cooking time will be needed when operating with a single magnetron.

- CH91 : Your oven does not work when one magnetron fails = Factory setting
- CH92 : Your oven works even if one magnetron fails.

To set magnetron failure options

Press the CUSTOM SETTING pad twice within 2 seconds then enter the numbers













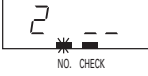



- 9, 1 to stop operation when one magnetron fails
- 9, 2 to allow operation of one magnetron only

Press the START pad to save settings and the STOP/CLEAR pad to exit from the Custom Setting Function.

10. Multiplication Factor for Double/Triple Quantity

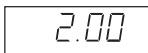
The multiplication factors of the double and triple quantities for memory cooking are preset to 1.80 and 2.60. You can check or change the multiplication factors.

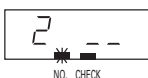
* Suppose you want to know the multiplication factor for double quantity with memory 1, and change it to 2.00 in any Memory Input Method.

Procedure	Display
 x 2 	
1 Press the CUSTOM SETTING pad twice within 2 seconds and press the DOUBLE/TRIPLE QUANTITY pad.	
	
	
2 Enter memory number.	After about 1 sec. 
	
3 Press the MANUAL/REPEAT pad.	
  	
4 Enter desired multiplication. (Ex : Enter 2, 0, 0 for 2.00.)	
	
5 Press the START pad to save settings.	
	
6 Press the STOP/CLEAR pad to exit from the Custom Setting Function.	

NOTES:

1. Only Dual Digit Input method can be used when inputting memory numbers in Multiplication Factor for Double/Triple Quantity.
2. The multiplication factors can be set from 0.01 to 9.99 for double quantity and triple quantity.
3. When you want to know the multiplication factor for triple quantity, press the DOUBLE/TRIPLE QUANTITY twice at step 1 after pressing the CUSTOM SETTING pad twice.
4. Multiplication Factors for Double/Triple Quantity can be checked or changed before pressing the STOP/CLEAR pad to exit for Custom Setting Function.

11. Express Defrost Setting

Express Defrosting uses 3 stages to defrost foods quickly. The defrosting sequence is preset as follows, but you can change the setting.

	Defrosting Time	Power Level
STAGE 1	T x A1: (0.20*) + B1: (20*) sec.	PL1 (40*) %
STAGE 2	T x A2: (0.13*) + B2: (30*) sec.	PL2 (30*) %
STAGE 3	T - STAGE1 - STAGE2	PL3 (20*) %
Pause Timing	See the table for The Pause Timing below (50*)	

T : INPUT TIME (TOTAL COOKING TIME)

* : The numbers in the parentheses are factory settings and can be adjusted.

Express Defrost is preset to pause during the sequence when 50% of total defrosting time has passed to check food. Pause timings can also be adjusted.

Pause Timing

KEY	Display	Pause Timing
0	0	No pause.
1	1	After 10% of total cooking time.
2	2	After 20% of total cooking time.
3	3	After 30% of total cooking time.
4	4	After 40% of total cooking time.
5	5	After 50% of total cooking time.
6	6	After 60% of total cooking time.
7	7	After 70% of total cooking time.
8	8	After 80% of total cooking time.
9	9	After 90% of total cooking time.
START	A	After ending of each stage

* Suppose you want to change the Express Defrost set factory settings to the following:

	Defrosting Time	Power Level
STAGE 1	T x 0.30 + 10 sec.	50%
STAGE 2	T x 0.15 + 20 sec.	20%
STAGE 3	T - STAGE1 - STAGE2	10%
Pause Timing	When 70% of total defrosting time has passed.	

Procedure	Display
-----------	---------

CUSTOM SETTING x 2 **EXPRESS DEFROST**













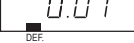





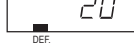



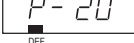

1 Press the CUSTOM SETTING pad twice within 2 seconds and press the EXPRESS DEFROST pad. (The Express Defrost setting of each phase is shown for 1.5 seconds per 0.3 seconds until the MANUAL/REPEAT pad is pressed.)

2 Press the MANUAL/REPEAT pad and enter desired multiplication for A1 at Stage 1. (Ex: Enter 3,0 for 0.30.)

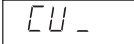

3 Press the MANUAL/REPEAT pad and enter desired time for B1 at Stage 1. (Ex: Enter 1 for 10 seconds.)

4 Press the POWER LEVEL pad and enter desired power level for PL1 at Stage 1. (Ex: Enter 5 for 50%)



Procedure	Display
5 Press the MANUAL/ REPEAT pad and enter desired multiplication for A2 at Stage 2. (Ex: Enter 1, 5 for 0.15.)	     
6 Press the MANUAL/ REPEAT pad and enter desired time for B2 at Stage 2. (Ex: Press 2 for 20 seconds.)	   
7 Press the POWER LEVEL pad and enter desired power level for PL2 at Stage 2. (Ex: Enter 2 for 20%)	   
8 Press the MANUAL/ REPEAT pad and enter the pause timing. (Ex: Enter 7 for when 70% of total defrosting time has passed.)	   
9 Press the POWER LEVEL pad and enter desired power level for PL3 at Stage 3. (Ex: Enter 1 for 10%)	   
	
10 Press the START pad.	
	
11 Press the STOP/CLEAR pad to exit from the Custom Setting Function.	

NOTES:

- See the table for Microwave Power Level on page 9 and The Pause Timing on page 16.
- You can enter minus numbers for B1 and B2 at steps 3 and 6. In that case, press the MANUAL/REPEAT pad twice at step 3 or 6 ( is displayed.) and enter desired time for or B1 and B2 at Stage 1 and 2. Press the MANUAL/REPEAT pad again to enter positive numbers. ( is displayed.)

Saving Memories











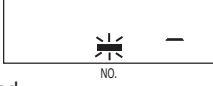

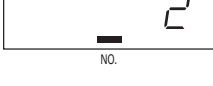

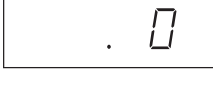

- * Memory 0 - 9 are programmed as factory settings. See the table of Programmed Memories on page 7.
- * Memories must be programmed before memory cooking can be used.

Memory banks
 Dual Digit: Memory 0-99
 Single Digit: Memory 0-9
 Repeat Digit Input: Memory 0-29
 Max. cooking stages: 4 stages

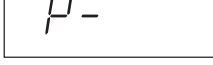
Setting time and power level for Single Stage

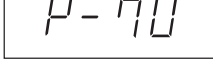
<Single Digit Input>

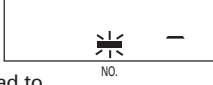
- * Suppose you want to set 1 minute at 70% with memory 2.











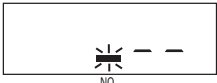



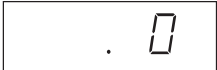

Procedure	Display
 X 2	
1 Press the SET MEMORY pad twice within 2 seconds.	
	
2 Enter memory number.	
	
3 Press the MANUAL/REPEAT pad.	
  	
4 Enter cooking time.	
	
5 Press the POWER LEVEL pad.	
	
6 Enter power level.	
	
7 Press the SET MEMORY pad to save memory.	
	
8 Press the STOP/CLEAR pad to exit.	

NOTES:

1. Press the SET MEMORY pad twice within 2 seconds.
2. If the cooking time is over the maximum time, the display will show error code EE9. To clear the error code, press the STOP/CLEAR pad and re-program. See Maximum Cooking Time on page 21.
3. It is not necessary to press the POWER LEVEL pad for 100% in Single Stage.

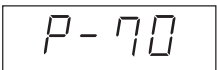
<Repeat Digit Input>

- * Suppose you want to set 1 minute at 70% with memory 12.











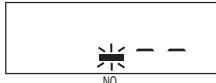







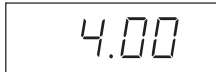



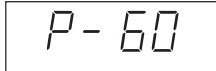

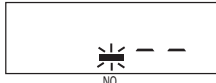
Procedure	Display
 X 2 1 Press the SET MEMORY pad twice within 2 sec.	
  2 Enter memory number.	
 3 Press the MANUAL/REPEAT pad.	
   4 Enter cooking time.	
 5 Press the POWER LEVEL pad.	
 6 Enter power level.	
 7 Press the SET MEMORY pad.	
 8 Press the STOP/CLEAR pad to exit.	

NOTES:

1. Press the SET MEMORY pad twice within 2 seconds.
2. If the programmed cooking time is over the maximum time, the display will show error code EE9. To clear the error code, press the STOP/CLEAR pad and re-program. See Maximum Cooking Time on page 21.
3. It is not necessary to press the POWER LEVEL pad for 100% in Single Stage.

<Dual Digit Input>

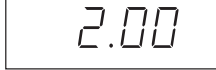
- * Suppose you want to set 4 minutes at 60% with memory 1 and 2 minutes at 30% with memory 2.

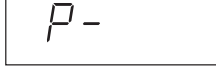
Procedure	Display
 X 2 1 Press the SET MEMORY pad twice within 2 seconds.	
  2 Enter memory number.	
 3 Press the MANUAL/REPEAT pad.	
   4 Enter cooking time for memory 1.	
 5 Press the POWER LEVEL pad.	
 6 Enter power level for memory 1.	
 7 Press the SET MEMORY pad to save memory 1.	
  8 Enter memory number.	
 9 Press the MANUAL/REPEAT pad.	
   10 Enter cooking time for memory 2.	
 11 Press the POWER LEVEL pad.	



Procedure	Display
3	P- 30
12 Enter power level for memory 2.	
SET MEMORY	NO. --
13 Press the SET MEMORY pad to save memory 2.	
STOP CLEAR	0
14 Press the STOP/CLEAR pad to exit.	

NOTES:

1. Press the SET MEMORY pad twice within 2 seconds.
2. If the programmed cooking time is over the maximum time, the display will show error code EE9. To clear the error code, press the STOP/CLEAR pad and re-program. See Maximum Cooking Time on page 21.
3. It is not necessary to press the POWER LEVEL pad for 100% in Single Stage.

Programming Multi Stage Cooking

* Suppose you want to set 4 minutes at 60% for the 1st stage and 2 minutes at 30% for the 2nd stage with memory 2 using of Dual Digit Input.

Procedure	Display
SET MEMORY X 2	NO. --
1 Press the SET MEMORY pad twice within 2 seconds.	
0 2	NO. 02
2 Enter the memory number.	
MANUAL REPEAT	. 0
3 Press the MANUAL/REPEAT pad.	
4 0 0	4.00
4 Enter cooking time for 1st stage.	
POWER LEVEL	P-
5 Press the POWER LEVEL pad.	







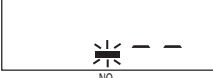

Procedure	Display
6	P- 60
6 Enter power level for 1st stage.	
MANUAL REPEAT	. 0
7 Press the MANUAL/REPEAT pad.	
2 0 0	2.00
8 Enter cooking time for 2nd stage.	
POWER LEVEL	P-
9 Press the POWER LEVEL pad.	
3	P- 30
10 Enter power level for 2nd stage.	
SET MEMORY	NO. --
11 Press the SET MEMORY pad to save memory.	
STOP CLEAR	0
12 Press the STOP/CLEAR pad to exit.	

NOTES:

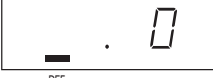
1. Press the SET MEMORY pad twice within 2 seconds.
2. If the programmed cooking time is over the maximum time, the display will show error code EE9. To clear the error code, press the STOP/CLEAR pad and re-program. See Maximum Cooking Time on page 21.
3. It is not necessary to press the POWER LEVEL pad for 100% in the last stage in Multi Stage Cooking.

Setting Total Cooking Time of Express Defrost

* Suppose you want to set the total cooking time of Express Defrost to 30 minutes with memory 2 using Dual Digit Input.

Procedure	Display
 X 2 1 Press the SET MEMORY pad twice within 2 seconds.	
0 2 2 Enter memory number.	
 3 Press the EXPRESS DEFROST pad.	
3 0 0 0 4 Enter cooking time.	
 5 Press the SET MEMORY pad.	
 6 Press the STOP/CLEAR pad.	

NOTES:

1. Press the SET MEMORY pad twice within 2 seconds.
2. If the programmed cooking time is over the maximum time, the display will show error code EE9. To clear the error code, press the STOP/CLEAR pad and re-program. See Maximum Cooking Time on page 21.
3. Refer to NOTES for Advice for Defrosting on page 27.

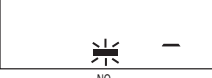
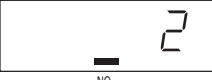

* Suppose you want to set the Total Cooking Time of Express Defrost to 30 minutes with memory 2 using Single Digit Input.

Procedure	Display
 X 2 1 Press the SET MEMORY pad twice within 2 seconds.	
2 2 Enter memory number.	

NOTES:

1. Follow steps 3-6 on the left side of page 20 to complete.
2. Press the SET MEMORY pad twice within 2 seconds.
3. If the programmed cooking time is over the maximum time, the display will show error code EE9. To clear the error code, press the STOP/CLEAR pad and re-program. See Maximum Cooking Time on page 21.
4. Refer to Defrosting 2 and 3 on page xx.

* Suppose you want to set the Total Cooking Time of Express Defrost to 30 minutes with memory 12 using Repeat Digit Input.

Procedure	Display
 X 2 1 Press the SET MEMORY pad twice within 2 seconds.	
2 2 2 Enter memory number.	

NOTES:

1. Follow steps 3-6 on the left side of page 20 to complete.
2. Press the SET MEMORY pad twice within 2 seconds.
3. If the programmed cooking time is over the maximum time, the display will show error code EE9. To clear the error code, press the STOP/CLEAR pad and re-program. See Maximum Cooking Time on page 21.
4. Refer to NOTES for Advice for Defrosting on page 27.



Maximum Cooking Time

1. 100%~60% power level : The Total Cooking Time of all cooking stages is maximum 60 minutes.
2. 50%~10% power level : The Total Cooking Time of all cooking stages is maximum 120 minutes.
3. Multi Stage Cooking : The Maximum Cooking Time is limited by the following calculation. Each stage has 100~60% power level or 50~10% power level.

Maximum Cooking Time Calculation

$$\text{Total Cooking Time of 100~60\% Power Level} + \frac{\text{Total Cooking Time of 50~10\% Power Level}}{2} \leq 60 \text{ minutes}$$

* Suppose you want to cook 5 minutes at 100% for 1st stage, 15 minutes at 80% for 2nd stage, 40 minutes at 30% for 3rd stage and 20 minutes at 10% for 4th stage. In this case actual Cooking Time is 80 minutes, and the calculated time is 50 minutes, see the calculation below.

$$[5\text{min} + 15\text{min}] + [(40\text{min} + 20\text{min})/2] \leq 60 \text{ min.}$$

4. 0% power level : Maximum 99 minutes and 99 seconds can be input at one stage (Max. 4 stages).
5. Express Defrost : The Maximum Defrosting Time is 90 minutes. See Maximum Cooking Time Calculation above.

OTHER CONVENIENT FEATURES

Demonstration Mode

To demonstrate, press the MANUAL/REPEAT pad, 0 and then press the START pad and hold for 3 seconds. Cooking operations can now be demonstrated with no power in the oven. The timer will count down rapidly.

To cancel, press the MANUAL/REPEAT pad, then 0 and the STOP/CLEAR pad or unplug your oven.

To set cooking during the Demonstration Mode, press the MANUAL/REPEAT pad and enter time and press the START pad. After cooking, press the STOP/CLEAR pad to show Demonstration again.

Monitor

Monitor function is used to check the power level during cooking.

To check the power level, press the POWER LEVEL pad and the power level will be displayed. As long as the POWER LEVEL pad is pressed, the power level is displayed. When the POWER LEVEL pad is released, the display will return to the previous display.

CLEANING & MAINTENANCE

⚠ WARNING:

- Do not allow grease or dirt to build up on the door seals and adjacent parts as this may prevent the door from closing correctly and may cause a leakage of microwaves. To clean use a mild detergent solution on a soft damp cloth.
- DO NOT OPERATE the oven without the splash cover in place.
- DO NOT REMOVE the splash cover UNLESS THE POWER CORD IS REMOVED FROM THE OUTLET because the rotary antenna, which is located on the ceiling, operates for 1 minute after the door is opened and injury could occur.
- * DO NOT REMOVE the antenna cover. It is not designed to be removable.
- * DO NOT OPERATE the oven without the air intake filter in place.
- * DO NOT REMOVE the ceramic floor from the oven. It is not designed to be removable.

- Keep the ceramic floor clean at all times. If you leave grease or fat in the cavity, it may overheat, smoke or even catch fire when next using the oven.
- Never use spray cleaners, oven keys or abrasive scourers as these damage the surface of the oven.
- Do not remove the ceramic floor from the oven.
- Do not use commercial oven cleaners, abrasive or harsh cleaners or scouring pads on any part of your microwave oven.
- The oven should be cleaned regularly and any food deposits removed.
- Do not sprinkle water with such as a water jet onto the oven directly. It may cause electric shock, leakage of electricity or damage of the oven.
- Failure to maintain the oven in a clean condition could lead to deterioration of the surface that could adversely affect the life of the appliance and possibly result in a hazardous situation.

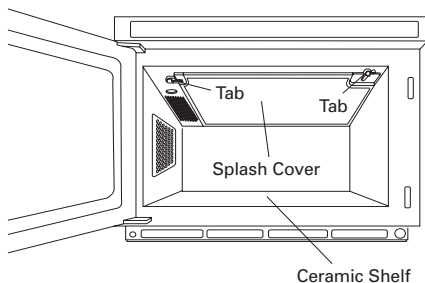

Fig.1

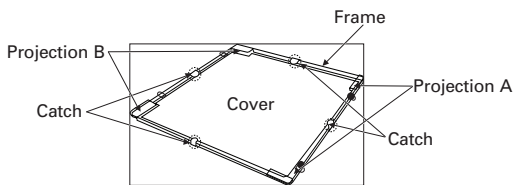

Fig.3 Splash Cover

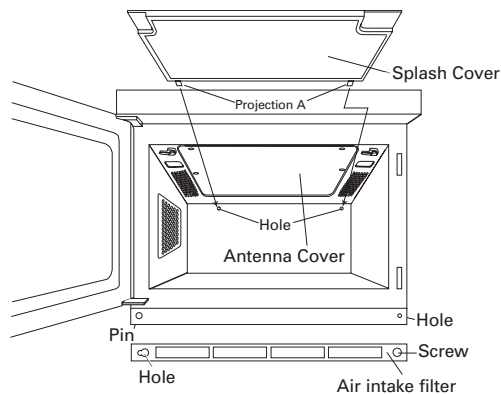

Fig.2



SPLASH COVER (Frame + Cover)

At least once a week, remove the splash cover and wash both sides of it in a mild detergent solution. A build up of grease may overheat and begin to smoke and may burn the splash cover. The splash cover is located in the top of the oven and may easily be removed. Remember to unplug the power cord.

SPLASH COVER (Frame + Cover)

Remove the splash cover as shown in Fig. 2 and separate the frame from the cover.

How to remove the splash cover

Remember to unplug the power cord. Turn the 2 tabs holding the oven cavity ceiling as shown in Fig. 2, then gently pull the cover downwards to separate from the oven cavity ceiling. Then separate the cover from the frame. It is held in place by 4 catches.

COVER:

Wipe any grease, spills or spatters on the oven ceiling cover with a soft cloth dampened with a mild detergent solution.

Don't soak the splash cover in detergent or wash it.

FRAME:

Wipe any grease, spills or spatters on the frame with a soft cloth dampened with a mild detergent solution. Scrape hardened spills or spatters with a plastic spatula. **Don't use metallic brushes or sharp-edged tools**, as scratches on the frame may cause the frame to warp or break during heating. To remove hardened spills or spatters, soak the frame in a mild detergent solution for a short period of time. **Don't use detergent with orange oil**, as the frame may melt.

How to install the splash cover

Remember to unplug the power cord. Replace the cover in the frame. Insert projection A (2) into the 2 holes in the rear cavity wall and then insert projection B (2) into the 2 holes in the oven cavity ceiling as shown in Fig. 2. Then slide the tabs in place.

ANTENNA COVER

If antenna cover has grease, spills or spatters, wipe antenna cover with a soft cloth dampened with a mild detergent solution. **Don't use metallic brushes or sharp-edged tools**, as scratches on the antenna cover may cause the cover to warp or break during heating.

OVEN INTERIOR

Clean the microwave oven cavity, at the end of each day with a damp soft cloth for hygienic reasons. For heavier soil, use mild soap applied with a soft damp cloth wipe clean ensuring all mild soap is removed. Make sure that mild soap or water does not penetrate through the small vents in the walls which may cause damage to the oven.

Take care not to let soapy water drip through the small holes in the oven walls. Excess water spillage through these holes will cause damage to the oven interior. It is important that the door seals and sealing surfaces are kept clean at all times, wipe regularly with a damp cloth.

The ceramic floor should be kept clean at all times. Minor spills may be wiped with a damp cloth. Do not use abrasive or harsh cleaners, scouring pads, metallic brushes or sharp-edged tools. Take care when cleaning to not damage the silicone seal.

Operating the unit with excessive buildup may result in cracking or breakage of the ceramic shelf. Do not operate the unit with a cracked or broken ceramic shelf.

Wipe the door and window on both sides frequently with a soft damp cloth or sponge to remove any spills or spatters. Always keep the door seals and seal surfaces clean so that any grease, spills or spatters are not allowed to build up. Build-up could result in leakage of microwave energy from the oven.

OUTER CABINET

Wipe the outside cabinet with a mild detergent solution on a soft cloth. The control panel must be wiped clean whilst the door is open, therefore inactivating the oven.

Keep the air intake filter clean. Clean the air intake filter once every two weeks (equivalent to 100 hours usage) or more often for heavy use. See Custom Setting 8 Air Intake Filter Counter on page 14. Loosen the screw holding the air intake filter to the oven and move the air intake filter to the left a little bit to remove the air intake filter from the pin. Wash the air intake filter in mild soapy water, rinse and dry with a soft cloth. After cleaning and drying completely, re-install the air intake filter.

Do not operate the oven without the air intake filter in place.

NOTES:

1. The screw can be loosened and tightened either by hand or by using a coin.
2. Install the splash cover properly. Operating the oven with an incorrectly installed splash cover may damage the components in the oven cavity and shorten the expected life span of your oven.



C OOKING ADVICE

! WARNING:

Always attend the oven when in use.





Carefully follow the SHARP Operation Manual at all times. If you exceed recommended cooking times and/or use power levels that are too high, food may overheat, burn, and in extreme circumstances, catch fire and damage the oven.

- The microwave power level will default to 100% unless you press the **POWER LEVEL** button for the desired setting. Take care when heating foods with high sugar or fat content, e.g. Christmas pudding, mince pies and fruit cakes. Before use, check that utensils are suitable for use in microwave ovens.
- **Lids:** Always remove lids from food jars and containers before using them in the oven. If you do not, steam and pressure will build up inside and the container may explode. Take care when heating contents in babies bottles, see page 25.
- Do not cook eggs in their shell as they will explode. **Do not** heat canned potatoes in the microwave oven as they may burst.





For microwaving, use only those utensils suitable for microwave cookery as indicated below.

A variety of cookware can be used for microwaving. Round/oval dishes rather than square/oblong ones are recommended, as food in the corners tends to overcook.

SUITABLE COOKWARE

COOKWARE	SUITABLE FOR MICROWAVING
<p>Heat resistant glass, (e.g. Pyrex®, Fire King®, Corning Ware ®).</p> 	<p>YES</p>
<p>Microwave-safe plastic cookware.</p> 	<p>YES</p>
<p>Microwave cling film , microwave roasting bags.</p> 	<p>YES Microwave cling film and bags must be vented for steam to escape, pierce in 4-5 places. Do not use plastic or metal ties as they may melt or catch fire due to 'arcing'.</p>
<p>Heat resistant china and ceramics.</p> 	<p>YES Except for dishes with metallic decoration.</p>
<p>Disposable containers: Thin plastic, paper, straw and wooden containers.</p> 	<p>YES Always attend the oven closely. Look at the oven from time to time when cooking or reheating food in disposable containers of plastic, paper or other combustible material. Only use for warming food. Pay special attention as over-heating may cause a fire in your oven.</p>



COOKWARE	SUITABLE FOR MICROWAVING
<p>Kitchen paper.</p> 	<p>YES Always attend the oven closely. Only use to absorb fat and moisture when warming food. Pay special attention as overheating may cause a fire in your oven.</p>
<p>Browning dishes & self-heating packages.</p> 	<p>YES Always place on an up-turned plate on the turntable to prevent heat stress. Follow manufacturer's instructions. Be careful as these become very hot. Popcorn: Only use microwave popcorn within recommended packaging (follow popcorn manufacturer's instructions). Never use oil unless the manufacturer recommends and never cook for longer than instructed.</p>
<p>Metal cookware.</p> 	<p>NO</p>
<p>Aluminium foil & foil containers, made from "Microfoil®".</p> 	<p>YES Use small pieces of aluminium foil to shield food from overheating. Keep foil at least 2cm from the oven walls. Foil containers are not recommended unless specified by the manufacturer, e.g. MicroFoil®, follow instructions carefully.</p>

 **Face & Hands:** Always use oven gloves to remove food or cookware from the oven. Stand back when opening the oven door to allow heat or steam to disperse. When removing covers (such as cling-film), opening roasting bags or popcorn packaging, direct steam away from face and hands.

 **WARNING:**

Check the temperature of food and drink and stir (before serving). Take special care when serving food to babies, children or the elderly. The contents of feeding bottles and baby food jars should be stirred or shaken and the temperature checked before consumption to avoid burns.



FOOD HANDLING & PREPARATION

Stir, turn & stand



For even cooking stir, turn or rearrange food during cooking. Where recommended, leave food to stand after cooking or defrosting.

Initial temperature



The initial temperature of food affects the amount of cooking time needed, for example, chilled food requires more cooking than food at room temperature. The temperature of the container is not a true indication of the temperature of the food or drink. Cut into foods with fillings, for example, jam doughnuts, to release heat or steam.

Piercing



Food with skin (e.g. potatoes, apples, fish, sausages, chicken), or with membrane (e.g. egg whites/yolks), must be pierced in several places before cooking or reheating. If not, steam will build up and may cause food to explode.

Arrangement



Place thickest parts of food on the outside of the dish, e.g. place the meaty ends of chicken drumsticks on the outside of the dish.

Covering

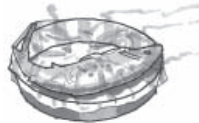

Fish, vegetables and certain other foods benefit from being covered during microwave cookery, follow recommendations where given and use vented microwave cling film or a suitable lid.

Size & shape



Food size and shape affect the amount of cooking time needed. When cooking more than one portion of the same food ensure they are of a similar size and shape.

Density & quantity



Food density and quantity affect the amount of cooking time needed, for example, potatoes require more cooking than peas; four potatoes will take longer to cook than two.

Composition & quality



Food high in fat or sugar (Christmas pudding, mince pies) requires less heating time and should be watched, over-heating can lead to fire. Use good quality ingredients for microwaving. Economical cuts of meat can be used for casseroles.

Hygiene



Food hygiene standards (storage, handling and preparation) apply to microwaving. Always store convenience foods as recommended by the food manufacturer and keep no longer than the "Use By" date.



ADVICE FOR DEFROSTING

Meat joints



Place in a flan dish, turn over at least 4-5 times during defrosting, shield any warm areas with small, flat pieces of foil. After defrosting, wrap in foil and allow meat to stand for 1-2 hours, until thoroughly defrosted.

Poultry



Place in a flan dish, turn over at least 3-4 times during defrosting, shield any warm areas with small, pieces of foil. After defrosting, wrap in foil and allow poultry to stand for 1-2 hours, until thoroughly defrosted.

NOTE: Do not defrost poultry with giblets.

Steak, Chops & Chicken Portions



Place in a flan dish, separate during defrosting and turn over at least 2-3 times. Shield if necessary.

Cubed & Minced Meat



Place in a bowl, remove defrosted parts and turn over at least 3-4 times during defrosting.

Whole fish & Fillets



Place in a flan dish, separate and turn over at least twice during defrosting. Shield if necessary.

Prepacked Frozen Foods



Remove packaging, including any foil and place in a suitable dish.

NOTES:

- To defrost food, use either MED LOW (20%) or DEFROST (10%) microwave power.
- Shield warm areas with small pieces of foil if necessary.
- It is important to turn food over, separate (where appropriate) and rearrange to ensure even defrosting.
- Standing time is necessary after defrosting to ensure thorough defrosting.





ADVICE FOR REHEATING

⚠ Oil & Fat: Never heat oil or fat for deep frying as this may lead to overheating and fire. Stand back when opening the oven door to allow heat or steam to disperse. When removing covers (such as cling-film), opening roasting bags or popcorn packaging, direct steam away from face and hands.

⚠ WARNING:

Never heat liquids in narrow-necked containers, as this could result in the contents erupting from the container and may cause burns.

- Remove food from foil or metal containers before reheating.
- Reheating times will be affected by the shape, depth, quantity and temperature of food together with the size, shape and material of the container.
- To avoid overheating and fire, special care must be taken when reheating foods with a high sugar or fat content, for example, mince pies, Christmas pudding.
- Canned potatoes should not be heated in the microwave oven, follow the manufacturers' instructions on the can.

Plated meals



Remove any poultry or meat portions, reheat these separately, see below. Place smaller items of food to the centre of the plate, larger and thicker foods to the edge. Cover with vented microwave cling film and reheat on MEDIUM (50%), stir/rearrange halfway through reheating. Ensure thoroughly reheated before serving.

Casseroles



Cover with vented microwave cling film or a suitable lid, reheat on MEDIUM (50%). Stir frequently to ensure even reheating.

Poultry portions



Place thickest parts of the portions on the outside of the dish, cover with microwave cling film and reheat on MEDIUM (50%). Turn over halfway through reheating.

NOTE: Ensure poultry is thoroughly reheated, before serving.

Sliced meat



Cover with vented microwave cling film and reheat on MEDIUM (50%). Rearrange at least once to ensure even reheating.

NOTE: Ensure meat is thoroughly reheated before serving.

Pies



Place pies on plate or in a flan dish. Reheat meat pies and fruit pies on MEDIUM (50%).

Vegetables



Cover with vented microwave cling film or suitable lid and reheat on MEDIUM (50%). Stir at least once during reheating.



DEFROSTING CHART

MANUAL DEFROSTING

FOOD	DEFROSTING TIME	MICROWAVE POWER LEVEL	METHOD
Beef, Lamb & Pork Joints (uncooked)	8 mins /450g (1lb)	LOW (10%)	<ol style="list-style-type: none"> 1. Place on a large plate. 2. Turn over 4-5 times during defrosting. <p>NOTE: If necessary, small pieces of aluminium foil can be used to shield small areas of meat which may become warm during defrosting.</p> <ol style="list-style-type: none"> 3. After defrosting, wrap in foil and leave to stand for 1-2 hours or until thoroughly defrosted.
Whole Poultry (uncooked)	6-7 mins /450g (1lb)	LOW (10%)	As above.
Minced Beef (uncooked)	2-4 mins /450g (1lb)	MEDIUM LOW (30%)	<ol style="list-style-type: none"> 1. Place on a plate or in a flan dish. 2. Turn over 2-3 times during defrosting, removing defrosted mince each time. 3. After defrosting, cover any frozen mince remaining with aluminium foil for 15-20 minutes or until thoroughly defrosted.
Sausages (uncooked)		LOW (10%)	<ol style="list-style-type: none"> 1. Place on a large plate, in a single layer if possible. 2. Turn over 2-3 times during defrosting and separate if necessary. 3. After defrosting, cover with aluminium foil and leave to stand for 15-20 minutes or until thoroughly defrosted.
	Thick 5-6 mins Thin 3-4 mins /450g (1lb)		
Bacon (uncooked)	5-6 mins /450g (1lb)	LOW (10%)	<ol style="list-style-type: none"> 1. Place on a plate. 2. Separate and re-arrange 3-4 times during defrosting. 3. After defrosting, cover with aluminium foil and leave to stand for 5-10 minutes or until thoroughly defrosted.
Sausage Rolls Large (cooked)	1-2 mins for 8 rolls, 375g (13oz) Total weight	LOW (10%)	<ol style="list-style-type: none"> 1. Place on a large plate. 2. Turn over and re-arrange halfway through defrosting. 3. After defrosting, cover with foil and leave to stand for 15-30 minutes or until thoroughly defrosted.
Quiche (cooked)	5-6 mins /450g (1lb)	LOW (10%)	<ol style="list-style-type: none"> 1. Place on a large plate. 2. After defrosting, cover with foil and leave to stand for 15-30 minutes or until thoroughly defrosted.
Meat Pie (cooked)	4 mins /450g (1lb)	LOW (10%)	As above.
Fruit Pie/ Crumble (cooked)	3-4 mins /450g (1lb)	LOW (10%)	As above.
Sponge Pudding (cooked)	2-3 mins /450g (1lb)	LOW (10%)	As above.
Bread Sliced	2-3 mins /800g (1 ³ / ₄ lb) loaf	MEDIUM LOW (30%)	<ol style="list-style-type: none"> 1. Arrange and separate slices on the turntable. 2. Turn over, separate and re-arrange twice during defrosting. Remove defrosted slices each time. 3. After defrosting, cover with foil for 5-10 minutes or until thoroughly defrosted.

DEFROSTING CHART

FOOD	DEFROSTING TIME	MICROWAVE POWER LEVEL	METHOD
Bread Buns	1-2 mins for 6 buns	LOW (10%)	<ol style="list-style-type: none"> 1. Place on turntable. 2. Turn over & re-arrange halfway through defrosting. 3. After defrosting, cover with foil and leave to stand for 10-15 minutes or until thoroughly defrosted.
Rice (cooked)	3½ mins /450g (1lb)	MEDIUM LOW (30%)	<ol style="list-style-type: none"> 1. Place in a large bowl. 2. Break up during defrosting, removing defrosted rice each time. 3. After defrosting, cover any frozen rice remaining with foil and leave to stand for 10-15 minutes or until thoroughly defrosted.

NOTES:

- Prior to defrosting, food is frozen approx. -18°C.
- If it is necessary to shield small areas of food, use small pieces of foil.
- Only use food which is thoroughly defrosted, use a professional food thermometer to ensure acceptable temperatures have been achieved throughout.

EXPRESS DEFROST

This is specially designed for smaller cuts of food. The following items are to be used on the express defrost programme.

1. Beef Steak
2. Lamb Chops
3. Pork Chops
4. Chicken Legs
5. Fish Fillets

The oven is pre-programmed with a time and power level cycle so that the food listed above is defrosted better and faster.

BASIC IDEAS FOR EXPRESS DEFROST

1. Always allow food to stand for approx. 30-45 minutes after defrosting to equalise the temperature and to produce better defrosting results.
2. Check food after standing. If the item is not thoroughly defrosted, continue to defrost on 20% power for additional time.
3. Choose foods that are the same thickness throughout. This will produce better defrosting results. Foods which vary in thickness may require shielding with small flat pieces of tin foil to prevent over-defrosting.
4. For foods not listed in the chart refer to the manual defrosting chart.
5. When freezing chicken legs, steak, chops and fish, freeze separately in single flat layers and if necessary interleave with freezer plastic to separate layers. This will ensure even defrosting.

FOOD	METHOD	TIME
Steak Pork, lamb chops Chicken Legs	<ol style="list-style-type: none"> 1. Position the food with thinner parts in centre in a single layer, if pieces are stuck together separate as soon as possible. 2. Turn over, rearrange after the audible sound. <p>After defrosting stand for 15-45 minutes.</p>	2½ mins /450g (1lb)
Fish Fillets	<ol style="list-style-type: none"> 1. Position the food in a single layer. 2. Shield any thinner parts with foil if necessary. 3. If pieces are stuck together separate as soon as possible. 4. Turn over, rearrange after the audible sound. 5. After defrosting allow to stand for 15-45 mins. 	2½ mins /450g (1lb)

COOKING CHART

FOOD	COOKING TIME	MICROWAVE POWER LEVEL	METHOD
Beef: Medium (Topside, Silverside) Chilled (5°C)	7-8 mins /450g (1lb)	MEDIUM HIGH (70%)	<ol style="list-style-type: none"> 1. Place fat side down in a flan dish. 2. Turn over halfway through cooking and remove juice. 3. After cooking, wrap in foil and leave to stand for 8 minutes before serving.
Lamb, medium (fillet, shoulder, leg) Chilled (5°C)	7-8 mins /450g (1lb)	MEDIUM HIGH (70%)	As above.
Pork (loin, leg) Chilled (5°C)	7-8 mins /450g (1lb)	MEDIUM HIGH (70%)	As above.
Poultry (whole) (max.3.5kg (8lb) Chilled (5°C)	5-6 mins /450g (1lb)	MEDIUM HIGH (70%)	<ol style="list-style-type: none"> 1. Place breast side down in a flan dish. 2. Turn over halfway through cooking and remove juice. 3. After cooking, wrap in foil and leave to stand for 10 minutes before serving.
Chicken Portions Legs Breast Chilled (5°C)	4-5 mins 6-7 mins /450g (1lb)	MEDIUM HIGH (70%)	<ol style="list-style-type: none"> 1. Place best side down in a single layer in a flan dish. 2. Turn over halfway through cooking & remove juice. 3. After cooking, wrap in foil and leave to stand for 5 minutes before serving.
Minced Beef Chilled (5°C)	4 mins /450g (1lb)	MEDIUM HIGH (70%)	<ol style="list-style-type: none"> 1. Place in a large bowl. 2. Stir 2-3 times during cooking. 3. After cooking cover bowl with foil and leave to stand for 2-3 minutes before serving.
Bacon Chilled (5°C)	2 mins for 8 rashers	HIGH (100%)	<ol style="list-style-type: none"> 1. Place in a single layer on a large plate. 2. Turn over halfway through cooking. 3. Leave to stand for 1 minute before serving.
Burgers (Thick) Chilled (5°C)	2 mins for 4 burgers/450g(1lb)	HIGH (100%)	As above
Sausages (thick) Chilled (50°C) (thin) Chilled (50°C)	2 mins for 8 sausages 2 mins for 12 sausages	HIGH (100%)	As above
Sliced Gammon Chilled (5°C)	4 mins for 1 slice/250g(9oz)	MEDIUM HIGH (70%)	As above
Fish Fillet/ Steaks Chilled (5°C)	3 mins /450g (1lb)	HIGH (100%)	<ol style="list-style-type: none"> 1. Place in a single layer in a large flan dish, cover with microwave cling film and pierce in 4-5 places. 2. Leave to stand for 2-3 minutes before serving.
Trout (whole) Chilled (5°C)	3 mins /450g (1lb)	MEDIUM HIGH (70%)	As above

C OOKING CHART

FOOD	COOKING TIME	MICROWAVE POWER LEVEL	METHOD
Rice/Pasta <i>Room</i> (20°C)	6-7 mins for 200g (70oz)	MEDIUM HIGH (70%)	<ol style="list-style-type: none"> 1. Place Rice/Pasta in a 2.5 litre casserole dish. 2. Add three times the volume of boiling water to quantity of rice. Do not cover. 3. Stir 3 times during cooking. 4. Stand for 2-3 minutes before rinsing in boiling water and serving.
Jacket Potatoes <i>Room</i> (20°C)	4-5 mins for 2 potatoes	HIGH (100%)	<ol style="list-style-type: none"> 1. Pierce each potato in several places. 2. Stand for 3-4 minutes before serving.
Corn on the Cob <i>Fresh</i> (20°C) <i>Frozen</i> (-18°C)	2-3 mins for 2 cobs 4-5 mins for 2 cobs	HIGH (100%)	<ol style="list-style-type: none"> 1. Place in a dish, add 60ml (4tbsp) water. 2. Cover with microwave cling film pierce in 4-5 places. 3. Turn over halfway through cooking. 4. Stand for 1-2 minutes before serving.
Beans (green) <i>Fresh</i> (20°C) <i>Frozen</i> (-18°C)	2 mins for 225g (8oz) 2-3 mins for 225g (8oz)	HIGH (100%)	<ol style="list-style-type: none"> 1. Place in a dish, add 30ml (2tbsp) water. 2. Cover with microwave cling film and pierce in 4-5 places. 3. Stir halfway through cooking. 4. Stand for 1-2 minutes before serving.
Broccoli <i>Fresh</i> (20°C) <i>Frozen</i> (-18°C)	2 mins for 225g (8oz) 3 mins for 225g (8oz)	HIGH (100%)	As above
Carrots (sliced) <i>Fresh</i> (20°C) <i>Frozen</i> (-18°C)	2 mins for 225g (8oz) 3 mins for 225g (8oz)	HIGH (100%)	As above
Carrots (baby, whole) <i>Fresh</i> (20°C) <i>Frozen</i> (-18°C)	2 mins for 225g (8oz) 3 mins for 225g (8oz)	HIGH (100%)	As above
Cauliflower <i>Fresh</i> (20°C) <i>Frozen</i> (-18°C)	2 mins for 225g (8oz) 3 mins for 225g (8oz)	HIGH (100%)	As above
Peas <i>Fresh</i> (20°C) <i>Frozen</i> (-18°C)	1-2 mins for 225g (8oz) 2-3 mins for 225g (8oz)	HIGH (100%)	<ol style="list-style-type: none"> 1. Place in a dish, add 30ml (2tbsp) water. 2. Cover with microwave cling film and pierce in 4-5 places. 3. Stir halfway through cooking. 4. Leave to stand for 1-2 minutes before serving.
New potatoes <i>Room</i> (20°C)	4 mins for 450g (1lb)	HIGH (100%)	<ol style="list-style-type: none"> 1. Place in a large dish, add 60ml (4tbsp) water. 2. Cover dish with microwave cling film and pierce in 4-5 places. 3. Stir halfway through cooking. 4. Leave to stand for 1-2 minutes before serving.
Mushrooms (fresh) <i>Room</i> (20°C)	1 min for 225g (8oz)	MEDIUM HIGH (70%)	<ol style="list-style-type: none"> 1. Chop or leave whole as desired. 2. Place in dish, cover with microwave cling film and pierce in 4-5 places. 3. Stir halfway through cooking.



C **OOKING CHART**

FOOD	COOKING TIME	MICROWAVE POWER LEVEL	METHOD
Tomatoes (fresh) Room (20°C)	1 min for 225g (8oz)	MEDIUM HIGH (70%)	<ol style="list-style-type: none"> 1. Slice or quarter as desired. NOTE: If you wish to leave whole, pierce in several places. 2. Place in a dish or on a plate, cover with microwave cling film and pierce in 4-5 places. 3. Leave to stand for 1-2 minutes before serving.
Scrambled Egg Chilled (5°C)	2 mins	HIGH (100%)	<ol style="list-style-type: none"> 1. Place 6 eggs (size 3), 150ml (1/4 pint) milk, 15g (1/2 oz) butter, salt and pepper in a bowl and beat thoroughly until smooth. 2. Beat 3 times during cooking until desirably set. 3. Leave to stand for 30 seconds before serving.

NOTES:

- Only serve food which is thoroughly cooked, use a professional food thermometer to ensure acceptable temperatures have been reached throughout.
- Hygiene - see Food Handling & Preparation, Page 26
- When cooking joints of meat small pieces of aluminium foil can be used to shield small areas of meat if they start to overcook.
- During standing time food should be covered. If covered during cooking, leave covered. If cooked uncovered, cover with foil.
- The cooking times given above are provided as a guide only. Cooking times will vary according to food weight, quality and initial temperature. Please ensure that food is thoroughly cooked before serving.

REHEATING CHART

FOOD	TEMP	QUANTITY	METHOD	REHEATING TIME ON HIGH (100%)
BREAKFAST				
Porridge	Chilled	125g (5oz)	Place in a bowl, uncovered	35 sec
Scrambled Egg	Chilled	125g (5oz)	Place on a plate, uncovered	30 sec
Scrambled Egg with bacon or sausage	Chilled	175g (6oz)	As above	50 sec
Bacon	Chilled	4 rashers	As above	25 sec
Sausages - thick	Chilled	4	As above	35 sec
Sausages-thin	Chilled	8	As above	35 sec
Smoked Haddock	Chilled	175g (6oz)	As above	45 sec
Mushrooms	Chilled	100g (4oz)	Place in a bowl, uncovered	15 sec
Fresh Tomatoes	Chilled	100g (4oz)	As above	15 sec
HOT SANDWICHES				
Chickenburger	Chilled	135g (5oz)	Place on a plate, uncovered	35 sec
Hamburger	Chilled	125g (5oz)	Place on a plate, uncovered	35 sec
Cheeseburger	Chilled	175g (6oz)	As above	35 sec
Hot Dog	Chilled	175g (6oz)	As above	35 sec
Bacon	Chilled	175g (6oz)	As above	35 sec
Sausage	Chilled	225g (8oz)	As above	50 sec
Beef	Chilled	175g (6oz)	As above	35 sec
PREPARED DISHES				
Lasagne	Chilled	300g (11oz)	1. Place on a plate, cover with cling film 2. Stand covered for 2-3 minutes	2 mins 15 sec
Chilli con Carne & Rice	Chilled	325g (12oz)	As above	2 mins
Curry & Rice	Chilled	300g (11oz)	As above	2 mins
Shepherds Pie	Chilled	300g (11oz)	As above	1 min 15 sec
Stew & Dumplings	Chilled	400g (14oz)	As above	2 mins 30 sec
Bangers & Mash	Chilled	325g (12oz)	Place on a plate, cover with cling film	1 min 15 sec

REHEATING CHART

FOOD	TEMP	QUANTITY	METHOD	REHEATING TIME ON HIGH (100%)
PREPARED DISHES				
Duck à l'orange	Chilled	540g (1lb 4oz)	As above	3 mins 15 sec
Spaghetti Bolognese	Chilled	300g (11oz)	As above	1 min 15 sec
Chicken in a sauce	Chilled	300g (11oz)	As above	2 mins 30 sec
Beef Stroganoff & Rice	Chilled	375g (13oz)	As above	2 mins 30 sec
BBQ Ribs	Chilled	375g (13oz)	As above	2 mins
Rice/Pasta	Chilled	225g (8oz)	As above	45 sec
SAVOURY BREAD AND PASTRY				
Dinner Roll(s)	Chilled	1	Place on the turntable, uncovered	5 sec
		2	As above	10 sec
Croissant(s)	Chilled	1	As above	4 sec
		2	As above	6 sec
Garlic Bread	Chilled	250g (9oz)	As above	20 sec
Pizza Slice	Chilled	125g (5oz)	Place on a plate, uncovered	25 sec
	Frozen	100g (4oz)	As above	50 sec
Pizza - small	Chilled	75g (3oz)	As above	15 sec
	Frozen	100g (4oz)	As above	20 sec
Pizza - large	Chilled	400g (14oz)	As above	1 min
	Frozen	400g (14oz)	As above	2 mins
Meat Pie - small	Chilled	125g (5oz)	1. Place on a plate, uncovered 2. Stand for 2-3 minutes	30 sec
Meat Pie - large	Chilled	450g (1lb)	1. Place on a plate, uncovered 2. Stand for 3-4 minutes	1 min 10 sec
Quiche - slice	Chilled	125g (5oz)	1. Place on a plate, uncovered 2. Stand for 2-3 minutes	30 sec
Quiche - whole	Chilled	540g (1lb 4oz)	1. Place on a plate, uncovered 2. Stand for 3-4 minutes	1 min 30 sec
Cornish Pastie(s) (175g) (6oz) each	Chilled	1	Place on a plate, uncovered	35 sec
		2	As above	1 min 10 sec
Sausage Roll(s) 75g (3oz) each	Chilled	1	Place on a plate, uncovered	15 sec
		2	As above	25 sec

REHEATING CHART

FOOD	TEMP	QUANTITY	METHOD	REHEATING TIME ON HIGH (100%)
CANNED FOODS				
Baked Beans	Room	450g (1lb)	Place in a bowl, cover with cling film, stir halfway through cooking	1 min 30 sec
Sausage & Beans	Room	450g (1lb)	As above	2 mins 10 sec
Soup - thick/thin	Room	425g (15oz)	As above	1 min 50 sec
Hot Dogs	Room	425g (15oz)	Place in a bowl, cover with cling film	1 min 45 sec
Peas	Room	550g (1lb 4oz)	Place in a bowl, cover with cling film, stir halfway through cooking	2 mins 10 sec
Sweetcorn	Room	325g (12oz)	As above	1 min 30 sec
Carrots - whole, sliced	Room	540g (1lb 4oz)	As above	2 mins 30 sec
Tomatoes	Room	400g (14oz)	As above	2 mins 30 sec
Asparagus	Room	350g (12oz)	As above	1 min 50 sec
Green Beans	Room	300g (11oz)	Place in a bowl, cover with cling film, stir halfway through cooking	2 mins 30 sec
FRESH VEGETABLES				
Green Beans	Chilled	125g (5oz)	Place on a plate, uncovered	30 sec
Broccoli	Chilled	125g (5oz)	Place on a plate, uncovered	30 sec
Carrots - sliced	Chilled	125g (5oz)	Place on a plate, uncovered	30 sec
Cauliflower	Chilled	125g (5oz)	Place on a plate, uncovered	30 sec
Corn on the Cob	Chilled	200g (7oz)	Place on a plate, uncovered	1 min 10 sec
Peas	Chilled	100g (4oz)	Place on a plate, uncovered	30 sec
Jacket Potatoes	Chilled	250g (9oz)	Place on the turntable, uncovered	1 min
New Potatoes	Chilled	225g (8oz)	Place on a plate, uncovered	1 min
Brussels Sprouts	Chilled	225g (8oz)	Place on a plate, uncovered	30 sec

REHEATING CHART

FOOD	TEMP	QUANTITY	METHOD	REHEATING TIME ON HIGH (100%)
MEAT PORTIONS				
Chicken Portions	Chilled	1 (300g) (11oz)	Place on a plate, cover with cling film	1 min
Leg Breast	Chilled	1 (400g) (14oz)	Place on a plate, cover with cling film	1 min 30 sec
Lamb Chops	Chilled	3 (225g) (8oz)	Place on a plate, cover with cling film	1 min 30 sec
Pork Chop	Chilled	1 (125g) (5oz)	Place on a plate, cover with cling film	50 sec
Sliced Meat with Gravy	Chilled	1 (225g) (8oz)	Place on a plate, cover with cling film	1 min 30 sec
Gammon-sliced	Chilled	1 (250g) (9oz)	Place on a plate, cover with cling film	55 sec
Trout	Chilled	1 (200g) (7oz)	Place on a plate, cover with cling film	1 min
Salmon Steak	Chilled	1 (200g) (7oz)	Place on a plate, cover with cling film	1 min
SWEET PORTIONS				
Fruit Crumble	Chilled	175g (6oz)	Place in a bowl, uncovered	35 sec
Fruit Crumble with custard	Chilled	275g (10oz)	Place in a bowl, uncovered	1 min
Fruit Pie	Chilled	175g (6oz)	Place in a bowl, uncovered	35 sec
Fruit Pie with Custard	Chilled	275g (10oz)	Place in a bowl, uncovered	50 sec
Sponge Pudding	Chilled	125g (5oz)	Place in a bowl, uncovered	20 sec
Sponge Pudding with Custard	Chilled	225g (8oz)	Place in a bowl, uncovered	45 sec
Suet Pudding	Chilled	175g (6oz)	Place in a bowl, uncovered	20 sec
Suet Pudding with Custard	Chilled	275g (10oz)	Place in a bowl, uncovered	45 sec
Chocolate Fudge Cake	Chilled	125g (5oz)	Place on a plate, uncovered	15 sec

NOTES:

- Only serve food which is thoroughly reheated, use a professional food thermometer to ensure acceptable temperatures have been reached throughout.
- Temperatures referred to in this chart are: *Room*, approx. 20°C, *Chilled*, approx. 5°C, and *Frozen*, approx. -18°C
- Hygiene - see Food Handling & Preparation, Page 26
- During standing time (where recommended) food should be covered. If covered during reheating, leave covered. If reheated uncovered, cover with foil.
- The reheating times given above are provided as a guide only. Reheating times will vary according to food weight, quality and initial temperature. Please ensure that food is thoroughly reheated before serving.



CAUTION

1. Do not operate the oven empty. Either food or water should always be in the oven during operation to absorb microwave energy.
2. Limit use of metal to those specific examples given in this booklet. Generally, metal should not be used in the microwave oven during operation.
3. Do not heat eggs in the shell. Pressure will build up inside the shell and it will explode. Do not reheat cooked eggs unless they are scrambled or chopped. Puncture the yolk before heating eggs.
4. Do not heat oil or fat for deep fat frying.
5. Pierce the "skin" of potatoes, whole squash, apples or any fruit, vegetable or meat with a skin covering before heating.
6. Use only popcorn packaged in special microwavable packages. Pop using 100% power. Listen carefully when popping corn. When popping slows to one or two seconds between pops, remove from oven. Should you ever smell scorching, remove bag from oven immediately. If any unpopped kernels remain, do not try to re-pop; it may cause a fire.
7. Do not use paper towels, plates or other utensils made from recycled paper for microwave heating. Recycled paper products may contain certain impurities which could cause the paper to ignite during microwave heating.
8. Stir liquids briskly before heating and allow to stand at least for 20 seconds after heating before stirring or drinking to avoid eruption.



TO REPLACE THE MAINS PLUG

The wires in the mains cable are colour coded as shown opposite:

As the colours of the cores in the mains lead of your oven may not correspond with the coloured marking identifying the terminals in your plug, connect the wires as shown: Make sure the terminal screws are tight and the cable is held securely by the cable grip where it enters the plug. Like most appliances in your home, your oven must be connected to a single phase 230-240 Volt, 50Hz alternating current supply. If you do not make the proper electrical connections you might damage the oven or injure yourself. Neither SHARP nor the supplier will be liable if this happens.

green and yellow stripes = EARTH
blue = NEUTRAL
brown = LIVE

- The green and yellow wire to the plug terminal marked E or \perp or coloured green or coloured green and yellow.
- The blue wire to the plug terminal marked N or coloured black or coloured blue.
- The brown wire to the plug terminal marked L or coloured red or coloured brown.

! WARNING:

**THIS APPLIANCE MUST BE EARTHED.
IF YOU HAVE ANY DOUBTS ABOUT YOUR ELECTRICAL
SUPPLY ASK A QUALIFIED ELECTRICIAN.**

CALLING FOR SERVICE

- If you are unable to resolve a problem using the checks covered on the last few pages, **do not attempt to service this microwave oven yourself.**
- Contact the dealer or supplier from whom the oven was purchased in order to obtain service. Where this is not possible, please contact the SHARP Customer Information Centre, telephone: 08705 274277 (office hours).

- For general information & assistance with oven queries, please contact our **Customer Information Centre:**
U.K.: 08705 274277 (office hours)
Ireland: 01 676 0648 (office hours)
Website: <http://www.sharp.co.uk/support>
- Replacement accessories may be obtained from our main parts distributor Willow Vale Electronics Ltd.
Telephone: 0121 766 5414



SPECIFICATIONS

AC Line voltage	Single phase 230-240V, 50Hz
AC Power required	2.8kW
Output power	1900W (IEC 60705)
Microwave frequency	2450MHz* (Group 2 / Class B)
Outside dimensions	445(W) x 346(H) x 573(D) mm (Single) 445(W) x 692(H) x 573(D) mm (Two ovens stacked)
Cavity dimensions	356(W) x 177(H) x 326(D) mm
Oven capacity	0.7 cu.ft (20 litres)
Cooking uniformity	Rotary antenna system
Weight	Approx. 33.5kg

* This Product fulfils the requirement of the European standard EN55011. In conformity with this standard, this product is classified as group 2 class B equipment. Group 2 means that the equipment intentionally generates radio-frequency energy in the form of electromagnetic radiation for heating treatment of food. Class B equipment means that the equipment suitable to be used in domestic establishments.
(This product is not limited to be used in domestic establishment, but it is suitable to be used at commercial location too.)



- As part of a policy of continuous improvement, we reserve the right to alter design and specification without notice.
- No part of this publication may be reproduced, stored in a retrieval system or transmitted in any form, electronic, mechanical, photocopied, recorded, translated or other means without prior permission from SHARP Electronics (U.K.) Ltd.
- The illustrations, technical information and data contained in this publication to our best knowledge, were correct at the time of going to print. The right to change specifications, at any time, without notice, is reserved as part of our policy of continuous development and improvement.



Attention:

Your product is marked with this symbol. It means that used electrical and electronic products should not be mixed with general household waste. There is a separate collection system for these products.

A. Information on Disposal for Users (private households)

1. In the European Union

Attention: If you want to dispose of this equipment, please do not use the ordinary dust bin!

Used electrical and electronic equipment must be treated separately and in accordance with legislation that requires proper treatment, recovery and recycling of used electrical and electronic equipment.

Following the implementation by member states, private households within the EU states may return their used electrical and electronic equipment to designated collection facilities free of charge*.

In some countries* your local retailer may also take back your old product free of charge if you purchase a similar new one.

*) Please contact your local authority for further details.

If your used electrical or electronic equipment has batteries or accumulators, please dispose of these separately beforehand according to local requirements.

By disposing of this product correctly you will help ensure that the waste undergoes the necessary treatment, recovery and recycling and thus prevent potential negative effects on the environment and human health which could otherwise arise due to inappropriate waste handling.

2. In other Countries outside the EU

If you wish to discard this product, please contact your local authorities and ask for the correct method of disposal.

For Switzerland: Used electrical or electronic equipment can be returned free of charge to the dealer, even if you don't purchase a new product. Further collection facilities are listed on the homepage of www.swico.ch or www.sens.ch.

B. Information on Disposal for Business Users

1. In the European Union

If the product is used for business purposes and you want to discard it:

Please contact your SHARP dealer who will inform you about the take-back of the product. You might be charged for the costs arising from take-back and recycling. Small products (and small amounts) might be taken back by your local collection facilities.

For Spain: Please contact the established collection system or your local authority for take-back of your used products.

2. In other Countries outside the EU

If you wish to discard of this product, please contact your local authorities and ask for the correct method of disposal.

SHARP

SHARP ELECTRONICS (U.K.) Ltd

4 Furzeground Way, Stockley Park, Uxbridge, Middlesex, UB11 1EZ.
London, U.K.

U.K.: 08705 274277 (office hours)

Ireland: 01 676 0648 (office hours)

Website: <http://www.sharp.co.uk/support>

TINSEB174WRRZ-K81

Printed in Thailand

