

## KPS 90 / KPS 60



<b>Betjeningsvejledning</b>	<b>DK</b>	<b>5</b>
<b>Instructions for use</b>	<b>GB</b>	<b>19</b>
<b>Bedienungsanweisung</b>	<b>D</b>	<b>33</b>
<b>Gebruiksaanwijzing</b>	<b>NL</b>	<b>47</b>
<b>Bruksanvisning</b>	<b>S</b>	<b>61</b>
<b>Mode d'emploi</b>	<b>F</b>	<b>75</b>

**GRAM**

**DK****Indhold**

Opstilling .....	5
Garanti og advarsel.....	5
El-tilslutning.....	5
Betjeningspanel .....	6
Igangsætning .....	8
Indstilling af sprog.....	8
Blæstkøling .....	9
Lagerprogram .....	10
Brugen af programmer.....	10
Afrimning.....	11
Indstillinger.....	12
Indstilling af tid og dato .....	15
Lagring af programmer .....	15
Alarmer .....	15
Udskrivning af data .....	16
Indgange/udgange.....	16
Blæserhastighed.....	17
Rengøring .....	17
Tøvand.....	17
Service .....	18
Bortskaffelse .....	18

**GB****Contents**

Location .....	19
Warranty and warning.....	19
Electrical connection .....	19
Control panel.....	20
Starting up.....	22
Setting the language .....	23
Blast chilling .....	23
Storage programme .....	24
Using the programmes.....	25
Defrosting.....	26
Settings .....	26
Setting time and date .....	29
Programme memory .....	29
Alarms .....	29
Printing data.....	30
Inputs/outputs .....	30
Fan speed .....	31
Cleaning.....	31
Defrost water.....	31
Service .....	31
Disposal .....	32

**D****Inhalt**

Aufstellung .....	33
Garantie und Wartung .....	33
Stromanschluß .....	34
Beschreibung der Bedientafel .....	34
Inbetriebnahme .....	36
Sprachwahl .....	36
Schockkühlen .....	37
Lagerprogramm .....	38
Einsatz der Programme .....	38
Abtauen .....	39
Einstellungen .....	40
Einstellen von Datum und Uhrzeit .....	43
Programmspeicherung .....	43
Alarmer .....	44
Ausdrucken von Daten .....	44
Ein- und Ausgänge .....	44
Lüftergeschwindigkeit .....	45
Reinigung .....	45
Tauwasser .....	45
Service .....	46
Entsorgung .....	46

**NL****Inhoud**

Opstellen/Plaatsen .....	47
Garantie en voorwaarden .....	47
Elektrische aansluiting .....	47
Bedieningspaneel .....	48
Inbedrijfstelling .....	50
Taal kiezen .....	50
Ventilatorkoeling .....	51
Opslagprogramma .....	52
De programma's gebruiken .....	52
Ontdooien .....	53
Instellingen .....	54
Instellen van tijd en datum .....	57
De programma's opslaan .....	57
Alarmer .....	57
Gegevens uitdraaien .....	58
Ingangen/uitgangen .....	58
Ventilatorsnelheid .....	59
Reinigen .....	59
Dooiwater .....	59
Onderhoud .....	60
Verschroten .....	60

**S****Innehållsförteckning**

Uppställning .....	61
Garanti och varning.....	61
Elanslutning .....	61
Beskrivning av kontrollpanelen .....	62
Igångsättning .....	64
Val av språk .....	64
Fläktkylning.....	65
Lagerprogram .....	66
Användning av program.....	66
Avfrostning.....	68
Inställningar.....	68
Inställning av tid och datum .....	71
Lagring av program.....	71
Larm .....	71
Utskrift av data .....	72
Ingångar/utgångar.....	72
Fläkthastighet.....	72
Rengöring .....	73
Tövatten .....	73
Service .....	73
Bortskaffning .....	74

**F****Table des matières**

Installation.....	75
Garantie et avertissement.....	75
Branchement électrique .....	75
Panneau de contrôle.....	76
Mise en marche .....	78
Choix de la langue .....	78
Réfrigération à froid ventilé.....	79
Programme de stockage.....	80
Utilisation des programmes .....	81
Dégivrage.....	82
Réglages.....	82
Réglage de l'heure et de la date .....	85
Mémorisation des programmes .....	85
Alarmes.....	86
Impression des données.....	86
Entrées/Sorties .....	86
Débit de soufflerie .....	87
Nettoyage.....	87
Eau de dégel.....	88
Maintenance .....	88
Elimination .....	88

# DANSK

## Opstilling

Skabet bør anbringes i et tørt og tilstrækkeligt ventileret rum. For at sikre en effektiv drift må anbringelse i direkte sollys eller nær varme flader undgås. Skabet er konstrueret således, at det kan arbejde ved en omgivelsestemperatur på op til +30°C. I udgaverne med ben, rettes skabet op, så det står helt lige, ved hjælp af stilleskruerne på benene.

## Garanti og advarsel

Garantiens gyldighed forudsætter, at følgende minimumskrav overholdes:

- 1) Kølesystemet må kun repareres af et autoriseret kølefirma.
- 2) De elektriske- og elektroniske dele må kun tilses/udskiftes af autoriseret mandskab.

### Advarsel:

Deres køle- / frysemøbel er specielt beregnet til nedkøling/indfrysning af madvarer og lignende varer. Skabet må ikke anvendes til opbevaring af varer, der frigiver eksplosionsfarlige dampe, da der således kan opstå risiko for eksplosion.

På steder hvor der er anvendt advarselstrekanter og/eller skruer til sikring af afskærmninger (f.eks. ved elektriske dele, varmelegemer og bevægelige dele såsom ventilatorer), må der kun åbnes, når strømmen er afbrudt på stikkontakten.

Indgreb må kun foretages af autoriseret mandskab.

Afbryderen på panelskærmen afbryder ikke strømmen til alle komponenter i møblet. Det er derfor forbundet med livsfare kun at afbryde på panelskærmens afbryder, hvis der åbnes til de elektriske dele. Afbryd derfor yderligere ved at fjerne stikkerledningen fra stikkontakten.

## EI-tilslutning

Skabet er beregnet for tilslutning til vekselstrøm. Tilslutningsværdierne for spænding (V) og frekvens (Hz) er vist på typeskiltet.

Denne blæstkøler/-fryser skal beskyttes mod indirekte berøring (ekstrabeskyttes) ifølge Stærkstrømsbekendtgørelsen. Dette gælder også, selv om der er tale om udskiftning af en eksisterende blæstkøler/-fryser, der ikke har været ekstrabeskyttet.

Formålet med ekstrabeskyttelsen er at beskytte brugeren mod farlige elektriske stød i tilfælde af fejl.

I bygninger opført efter 1. april 1975 vil alle stikkontakter i køkken og eventuelt bryggers være omfattet af en ekstrabeskyttelse.

I bygninger opført før 1. april 1975 er ekstrabeskyttelsen i orden, hvis der er installeret HFI- eller HPFI-afbryder, som omfatter den stikkontakt, blæstkøleren/-fryseren skal forbindes til.

I begge disse tilfælde skal der:

- hvis stikkontakten er for trebenet stikprop, benyttes en trebenet stikprop, og lederen med grøn/gul isolation skal tilsluttes jordklemmen.
- hvis stikkontakten kun er for tobenet stikprop, benyttes en tobenet stikprop. Hvis brugeren selv monterer denne, skal lederen med grøn/gul isolation klippes af så tæt som muligt på det sted, hvor ledningen går ind i stikproppen.

I alle andre tilfælde bør De lade en autoriseret elinstallatør undersøge, hvordan De nemmest får ekstrabeskyttet blæstkøleren/-fryseren. Elektricitetsrådet anbefaler, at den krævede ekstrabeskyttelse udføres med HFI- eller HPFI-afbryder.

Hvis De er i tvivl, spørg Deres leverandør eller elinstallatør om råd.

Kontroller, at systemets elektriske kapacitet er tilstrækkelig til blæstkølerens/-fryserens maksimale ydelse, der er anført på typenummerskiltet.

For at undgå farlig overhedning anbefales det, at tilledningen udrulles i hele sin længde.

## Beskrivelse af kontrolpanelet

Før skabet tages ibrug, skal den nedenstående beskrivelse af det elektroniske kontrolpanels styringsfunktioner læses grundigt igennem.

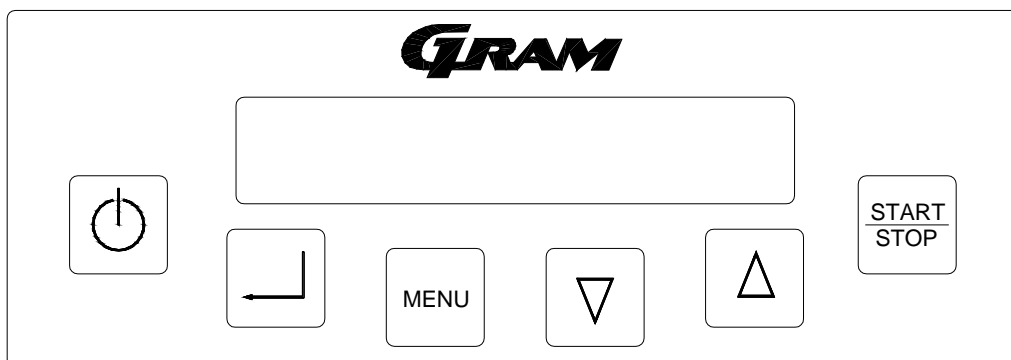

### Taster:



#### **On/off**

Ved at trykke på  i 5 sekunder, slukkes styringen og displayet viser **OFF**. Ved at trykke på tasten igen, tændes for styringen i standby tilstand.



#### **Ved service:**

Hvis der foretages service på de elektriske dele, skal der afbrydes på stikkontakten. Det er **ikke** nok at afbryde skabet på ON/OFF tasten, da der stadig vil være spænding til enkelte elektriske dele på skabet.



#### **Enter**

Giver adgang til menuen eller valg af parametre.

MENU

## Menu

Giver adgang til hovedmenuen, eller retur til den foregående menu. For at få adgang til de

forskellige menuer, tryk på tasten og vælg den ønskede menu ved hjælp af piletasterne



Menu 01  
Indstillinger

Indstillinger for blæstkøl.

Menu 02  
Lager

Indstillinger for lager.

Menu 03  
Program

Valg af programmer.

Menu 04  
Afrimning

Start af afrimningsproces.

Menu 05  
Indstilling

Programindstillinger.

Menu 06  
Ur indstilling

Indstilling af ur.

Menu 07  
Hukommelse

Lagring af programmer.

Menu 08  
Alarm

Alarm indstillinger.

Menu 09  
Udskriv

Udskrivning af data.

Menu 10  
Indgang/udgang

Status for indgange og udgange.

Menu 11  
Sterilisering

Ingen funktion i dette produkt.

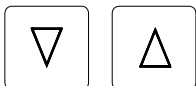

**Piletaster op/ned.**

Anvendes til at bladre i menuer, eller ændring af værdier.



**Start/stop.**

Start / stop af proces.

## Igangsætning

Tilslut skabet korrekt til el-nettet.

Tryk på  knappen.





Tryk dernæst på , og vælg den ønskede menu ved hjælp af piletasterne  .

## Indstilling af sprog

Vælg **Menu 05**, og tryk på  for at komme ind i menuen. Displayet viser:

indstilling  
password 0





Password indstillet fra fabrikken: **-19**

Vælg password ved hjælp af piletasterne  , og tryk på . Tryk nu på  for at komme ind i hovedmenuen for programmering.



Vælg **Set Up 04**. Tryk derefter på , herefter vises den første sprogindstilling i displayet:



sprog  
dansk

Brug piletasterne   til at bladere frem til det ønskede sprog. Tryk på  for at bekræfte valget af det pågældende sprog, eller tryk på  for at vende tilbage uden at ændre sprogindstillingen.

## Blæstkøling

Vælg **Menu 01** for at indstille og starte en nedkølingsproces. Tryk på  for at få adgang til at indstille nedkølingsprocessen.

Valg af blæstkøl/blæstfrys:

Tryk nu på  for at ændre indstillingerne, der nu blinker i displayet, ved hjælp af piletasterne  .

blæstkøl plus ↔ blæstkøl minus ↔ blæstkøl hard

Tryk på  for at vælge den ønskede indstilling.

Valg af tidsstyret eller temperaturstyret nedkøling:

Brug derefter piletasterne   til at indstille om der skal køres efter tid eller kerntemperatur:



blæstkøl tid ↔ blæstkøl kerne

Vælges tidsstyret nedkøling, kan tiden indstilles:

længde  
120 min

Vælges kerntemperaturstyret nedkøling, kan temperaturen indstilles:

set point  
-25

Tryk på  for at starte den valgte proces, eller tryk på  for at forlade programmet uden starte processen.

**OBS:** Under nedkølingsprocessen er det muligt at gå ind i **Menu 01** for at se indstillingerne, men de kan ikke ændres så længe processen kører.

Nedkølings- og indfrysningshastigheden afhænger af følgende faktorer:



- Madvaretykkelse og de anvendte beholders form, type og materiale
- Madvaremængde og -sammensætning
- Beholdere med eller uden låg
- Madvarenes temperatur ved påbegyndelse af nedkøling / indfrysning
- Madvarenes varmeledningsevne

Tiden for hurtig nedkøling / indfrysning er desuden afhængig af den behandlede madvaretype. Af hensyn til nedkølingstiden bør indholdet pr. 1/1 GN-kantine ikke overstige 3,5 kg, eller en lagtykkelse på 50 mm. Ved behandling af vanskelige og/eller store varer bør lagtykkelsen reduceres yderligere.



Placer madvarerne i blæstkøleren, således at de er jævnt fordelt i hele skabets indvendige højde. 1/1 GN-kantiner placeres så tæt på blæsesektionen som muligt og med en indbyrdes afstand, som muliggør en passende luftcirkulation (ca. 25 mm).

## Lagerprogram

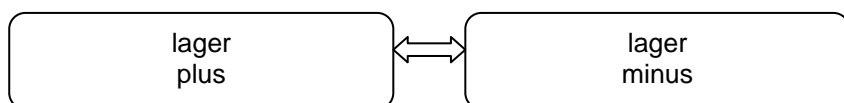

Vælg **Menu 02**, og tryk på  for at komme ind i menuen.

Tryk på  for at ændre indstillingerne. Brug piletasterne   til at vælge køl eller frys:

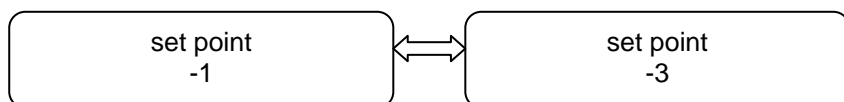

Tryk på  for at vælge det ønskede program. Brug piletasterne   til at ændre setpunktet:



Tryk på  for at starte det valgte program, eller tryk på  for at forlade programmet.



## Brugen af programmer

Det er muligt at anvende brugerprogrammer, som man selv har gemt, eller at vælge mellem en række fast indstillede programmer.

Brugerprogrammer:

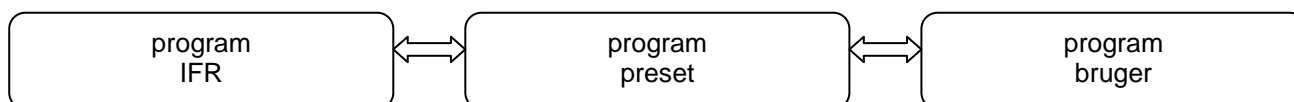

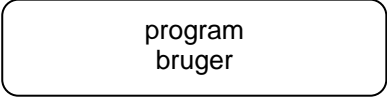

Vælg **Menu 03**, og tryk på  for at komme ind i menuen:

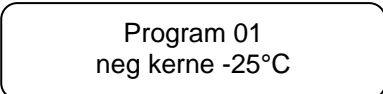

Vælg  og tryk på  for at komme ind i brugerprogrammerne (01-20).



Displayet viser program nummeret og hvilken type proces der er lagret:



Brug piletasterne   til at vælge program med. Tryk på  for at starte det valgte program, eller tryk på  for at forlade programmet uden starte processen.

Ved at trykke på  vælges det pågældende program, og skabet går i stand-by tilstand.

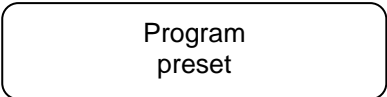
### Fast indstillede programmer:

Vælg  og tryk på  for at komme ind i de fast indstillede programmer (21-29).



Find det ønskede program ved hjælp af  . Tryk på  for at starte det valgte program, eller tryk på  for at forlade programmet.

Der er følgende programmer at vælge imellem:

Prog	Navn	Positiv/negativ	Tid/temperatur	Hard	Rumtemp. setpunkt lager	Tid
21	kød	positiv	temperatur	ja	+2°C	120 min.
22	mejeriprd	positiv	tid	nej	+2°C	90 min.
23	tærter	positiv	tid	nej	+2°C	90 min.
24	sammenkogt	positiv	tid	nej	+2°C	90 min.
25	fisk	positiv	tid	ja	+2°C	90 min.
26	kylling	positiv	tid	ja	+2°C	90 min.
27	grønsager	positiv	tid	nej	+2°C	90 min.
28	fryse temp	negativ	temperatur	ja	-22°C	240 min.
29	fryse tid	negativ	tid	ja	-22°C	240 min.

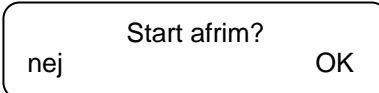
## Afrimning

Vælg **Menu 04**, og tryk på  for at komme ind i menuen. Displayet viser: 

Afrimningen startes ved trykke på . For at de-aktivere afrimningen, tryk på .

Tryk på  for at gå tilbage til menuen uden at starte afrimningen.





**OBS:** Afrimning kan aktiveres direkte fra hovedmenuen ved at trykke  ind i 5 sekunder.

## Indstillinger





Vælg **Menu 05**, og tryk på  for at komme ind i menuen. Displayet viser:

indstilling  
password 0

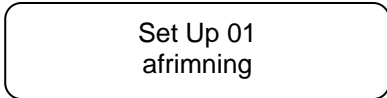
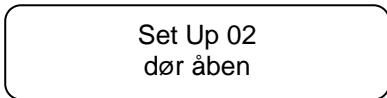
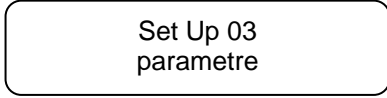
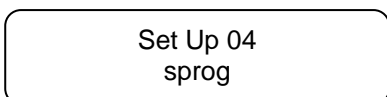
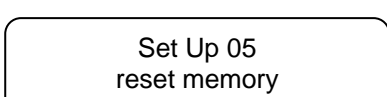
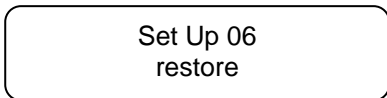
Password indstillet fra fabrikken: **-19**

Vælg password vedhælp af piletasterne  , og tryk på . Tryk nu på  for at komme ind i hovedmenuen for programmering:

	Viser de seneste afrimninger.
	Viser de seneste døråbninger.
	Ændring af parametre.
	Valg af sprog.
	Reset af hukommelsen.
	Reset af værdier til fabriksindstilling.

Brug piletasterne   til at vælge undermenuerne med. Vælg den ønskede undermenu med . Tryk på  for at vende tilbage til hovedmenuen.

### Visning af de seneste afrimninger:

Vælg **Set Up 01**. Tryk derefter på  for at se de seneste 32 afrimningsprocesser og de dertil hørende data. Displayet viser starttid og dato, varighed af afrimningen i minutter, samt rækkefølgen fra D01 til D32.

D09      22Min      M=03  
S 11:44 10/06/05

M indikerer hvorledes afrimningen er igangsat:

M=01 Afrimning startet manuelt under lagerkøling.

M=02 Periodisk afrimning under lagerkøling.

M=03 Afrimning startet ved start af nedkølingsproces.

Det er muligt at bladre i afrimningerne ved hjælp af  .

Hvis der ikke er gemt nogen afrimninger, viser displayet **No Date**.

Tryk på  for at vende tilbage til hovedmenuen.

### Visning af døråbninger:

Vælg **Set Up 02**. Tryk derefter på  for at se de seneste døråbninger. Styringen husker døråbningerne i op til 31 dage.

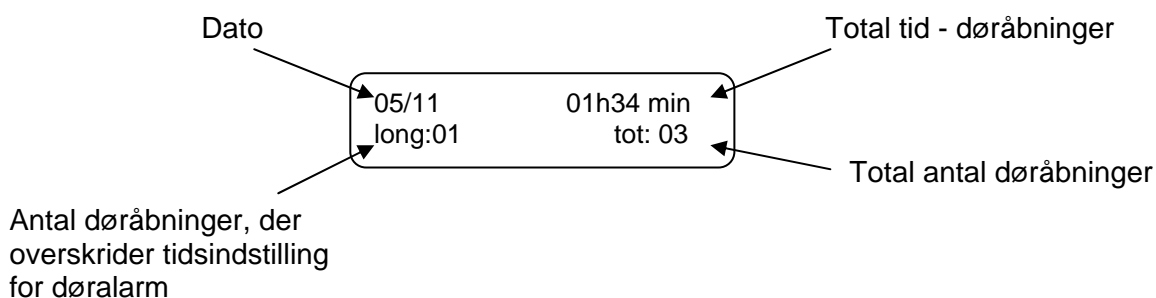

Brug piletasterne   til at vælge de øvrige datoer for døråbning.



Tryk på  for at vende tilbage til hovedmenuen.

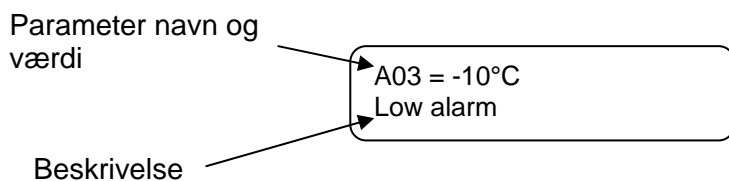

### Ændring af parametre:

Vælg **Set Up 03**. Tryk derefter på  for at få adgang til indstilling af parametre.



Brug piletasterne   til at bladre i de forskellige parametre.

For at ændre en parameter, tryk på , og brug dernæst piletasterne   til at ændre værdien med.

Tryk igen på  for at bekræfte den nye værdi. Tryk på  for at vende tilbage til menuen.

### Oversigt over parametre:

Parameter	Beskrivelse	Fabr. indstilling	Min.	Max.
<b>Blæstkøl, plus</b>				
P01	Rumtemperatur setpunkt, soft	-5°C	-30°C	30°C
P02	Rumtemperatur setpunkt, hard	-25°C	-40°C	30°C
P03	Spydtemperatur setpunkt, soft	3°C	-30°C	30°C
P04	Spydtemperatur setpunkt, hard	20°C	-30°C	30°C
P05	Varighed af proces	90 min	0 min	900 min
P06	Hard fase længde i % relativ til P05	60%	0%	100%
P07	Rumtemperatur setpunkt, lager	2°C	-30°C	30°C
<b>Blæstkøl, minus</b>				
N01	Rumtemperatur setpunkt	-25°C	-40°C	30°C
N02	Spydtemperatur setpunkt	-18°C	-30°C	30°C
N03	Varighed af proces	240 min	0 min	900 min
N04	Rumtemperatur setpunkt, lager	-22°C	-40°C	30°C
<b>Alarmer</b>				
A01	Temperaturalarm hysteres	2°C	0°C	10°C
A02	Øvre temperaturalarm, relativ til P07	10°C	0°C	50°C
A03	Nedre temperaturalarm, relativ til P07	-10°C	-50°C	0°C
A04	Øvre temperaturalarm, relativ til N04	10°C	0°C	50°C
A05	Nedre temperaturalarm, relativ til N04	-10°C	-50°C	0°C
A06	Temp.alarm forsinkelse fra lager eller afrimn.start	60 min	0 min	300 min
A07	Temp.alarm forsinkelse	30 min	0 min	300 min

For indstilling af øvrige parametre henvises der til Betjenings- og servicemanualen. Denne kan om nødvendigt rekvireres hos Deres forhandler.

### Reset af hukommelsen:

Vælg **Set Up 05**. Tryk på  for at nulstille hukommelsen.

Reset memory?	
No	OK

Tryk på  for at bekræfte nulstilling af hukommelsen.

Tryk på  for at forlade menuen uden at nulstille hukommelsen.

### Reset af værdier til fabriksindstillinger:

Vælg **Set Up 06**. Tryk på  for at gå ind i menuen, displayet viser:

Default		
No		OK

Tryk på  for at gendanne default parametrene.





Tryk på  for at forlade menuen.

## Indstilling af tid og dato

Tid og dato i styringen indstilles på følgende måde:

Vælg **Menu 06**, og tryk på  for at komme ind i menuen. Displayet viser:





Date: 10/06/05  
Hour: 14:22:46

Det blinkende ciffer ændres ved at bruge piletasterne  . Tryk på  for at gemme og gå videre til næste ciffer. Tryk på  for at vende tilbage til hovedmenuen.

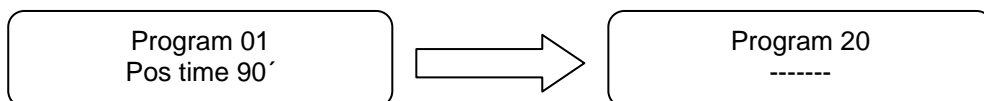
## Lagring af programmer

Vælg **Menu 07**, og tryk på  for at komme ind i menuen. Displayet viser program nummeret og viser desuden om det er lagret eller ej:



Brug piletasterne   til at gennemse programmerne fra 01 til 20. For at gemme et program, tryk på  tasten. For at gå ud af programmet uden at gemme, tryk på .

## Alarmer

Styringen gemmer de alarmer der har været i hukommelsen, og det er muligt at se dem ved at gå ind i dette menupunkt. Der kan gemmes op til 30 alarmer i hukommelsen.

Vælg **Menu 08**, og tryk på  for at komme ind i menuen.

Hvis der ikke er gemt nogen alarmer, viser displayet:



No date

Displayet viser alarmerne i rækkefølge fra A01 til A30. Desuden vises tidspunktet for alarm start og dato:

A05 Err room  
S 14:21 10/06/05

Ved at trykke på  fås øvrige oplysninger om alarmtypen: max eller min temperatur, varighed, tilkald service, tidspunkt for de-aktivering, eller om alarmen stadig er aktiv:

A05 Err room  
Present

Man kan bladre i alarmmenuen med piletasterne  .

Tryk på  for at gå tilbage til hovedmenuen.

## Udskrivning af data

**OBS:** Denne funktion kræver ekstra udstyr.

Vælg **Menu 09**, og tryk på  for at komme ind i menuen. Displayet viser: No      udskriv data?      Ok

Tryk på  for at udskrive data.

Tryk på  for at forlade menuen uden at udskrive.

## Indgange/udgange

I denne menu vises de aktuelle værdier for indgange og udgange, f.eks. de aktuelle temperaturer på følere og status for relæer.

Vælg **Menu 10**, og tryk på  for at komme ind i menuen.

Man kan bladre i de forskellige data med piletasterne  .

Room	-6°C
Needle	15°C

Rum- og spydtemperatur.

Evapor.	-10°C
Conden.	21°C

Fordamper- og kondensatortemperatur.

C	D	FE	FC	L	R	A
1	0	0	1	1	0	0



Outputs:  
1= relæ aktiveret  
0= relæ de-aktiveret

DI1	DI2	FAN
0	1	80

Digitale inputs og fordamperblæser hastighed.



## Blæserhastighed

Blæserne er normalt indstillet til at køre med 100% hastighed. Det er dog muligt at reducere hastigheden til 50%. Ved at trykke på  mens processen er i gang, kan man se den aktuelle hastighed. Hastigheden kan ændres ved at trykke på .

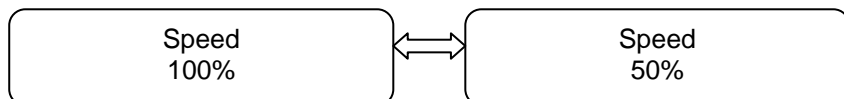

Tryk på  for at forlade programmet.

## Rengøring



**Før rengøring skal skabet afbrydes på stikkontakten.**

Der må ikke spules med vand i kompressorummet og ved køleelementet, da der kan opstå kortslutninger, skader og lign. på de elektriske dele.

Med passende mellemrum skal det indvendige og udvendige møbelrum rengøres med en svag sæbeopløsning og efterses grundigt, inden møblet sættes i drift igen.

Møblets udvendige flader kan vedligeholdes med plejespray for rustfri stål.



**Rengøringsmidler indeholdende klor eller klorforbindelser, samt andre aggressive midler må ikke anvendes, da de kan forårsage tæring på de rustfri flader og på det indvendige kølesystem.**

Kompressorummet og især kondensatoren skal holdes fri for støv og snavs, hvilket gøres bedst med en støvsuger og en stiv børste.

Få evt. rengøring af kondensatoren noteret i rengøringsplanen.

## Tøvand

Tøvandet ledes gennem et rør i isolationen. Røret er ført ud på skabets bagside. Der skal etableres en vandlås, før vandet føres til kloak afløb.

**OBS:** Det er vigtigt at holde vandlåsen ren, da tøvandet ellers kan løbe tilbage i skabet.

## Service

Kølesystemet kræver intet tilsyn - kun renholdelse. Svigter kølevirkningen må De først undersøge, om årsagen er utidig afbrydelse ved stikkontakten eller en afbrydelse i sikringsgruppen. Kan grunden til kølevirkningens ophør ikke findes, må De henvende Dem til Deres leverandør. Ved henvendelse bedes skabets typenavn, part- og serienummer opgivet. TYPE, PART NO. og SER. NO. kan findes på typeskiltet.

Placering af typeskiltet:

### KPS 90

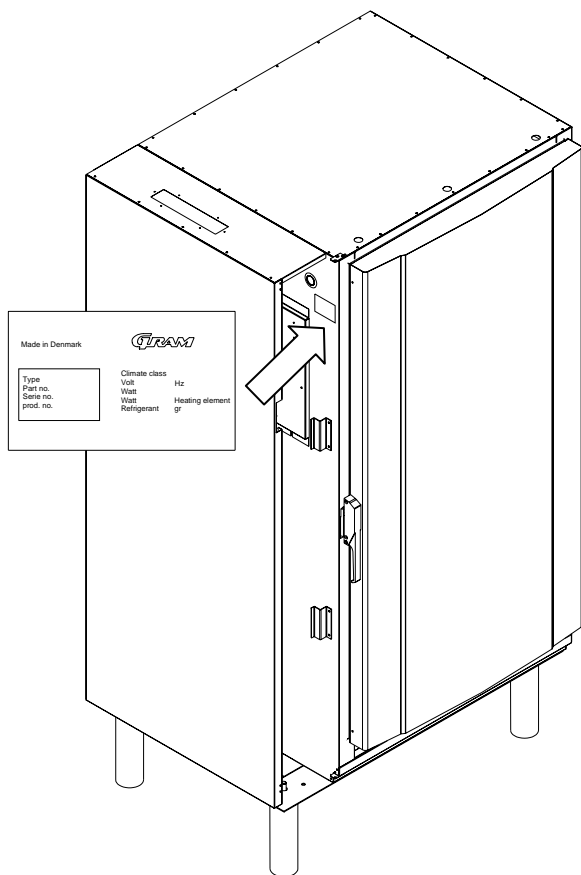

### KPS 60

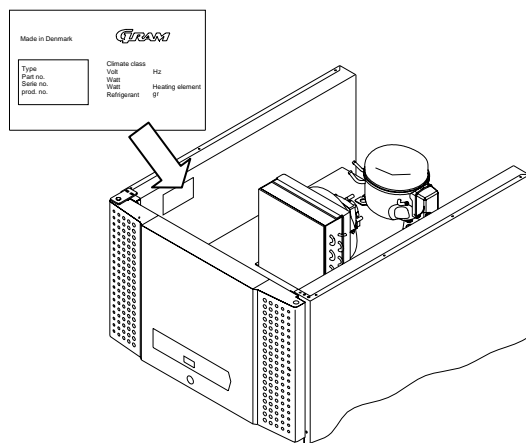

## Bortskaffelse

Når det udtjente skab skal bortskaffes, skal det ske på en miljømæssig korrekt og forsvarlig måde. Kontakt Elretur på tlf 33 36 91 98.

## ENGLISH

### Location

The cabinet should be placed in a dry and adequately ventilated room. To ensure effective operation, do not place it in direct sunlight or near a heat source. The cabinet is designed to operate in an ambient temperature of up to +40°C. The adjustment screws on the legs can be used to make sure the cabinet stands level.

### Warranty and warning

#### Warranty:

The validity of the warranty is conditional on the following minimum requirements being observed:

- 1) The refrigerating system may only be repaired by authorised personnel.
- 2) Electrical and electronic parts may only be inspected/replaced by authorised personnel.

#### Warning:

Your blast chiller is designed for chilling/freezing of food and similar items.

The cabinet must not be used to store items that release explosive vapour which might create the risk of explosion.

At points where a warning triangle is used to indicate that shielding should not be removed and/or screws are used to secure shields (e.g. around electrical parts, heating element and moving parts such as fans), the shielding concerned must not be removed until the power has been disconnected at the plug.

Any service or repair work may only be performed by authorised personnel.

The switch on the panel screen does not cut off power to all components in the appliance. It is therefore highly dangerous to switch off only at the panel screen if electrical parts are exposed. Therefore, further isolate the cabinet by pulling out the plug.

To ensure that no water penetrates electrical parts, ensure that while cleaning no water is sprayed directly onto the panel screen and refrigerating system of the appliance.

### Electrical connection

The cabinet is intended for connection to alternating current. The connection values for voltage (V) and frequency (Hz) are given on the nameplate inside the cabinet:

230V 50Hz

## Control panel

Before starting the cabinet, it is very advisable to carefully read the following description of the electronic control panel and its functions.

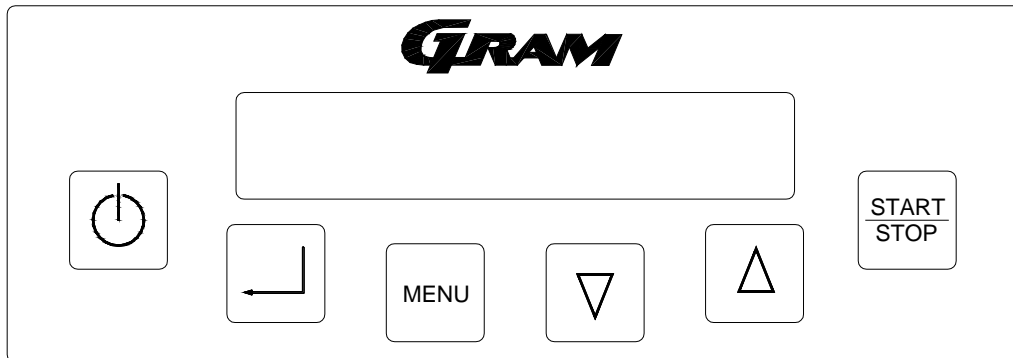

### Keys:



#### **On/off**

Pushing  for 5 seconds turns off the controller, and the display shows **OFF**. Pushing the key again, turns on the controller in standby mode.



#### **Servicing:**

Make sure the appliance is switched off at the socket before service is performed on electrical parts. It is not sufficient to switch off the cabinet by the START/STOP key as there will still be voltage to some electrical parts of the cabinet.





#### **Enter**

Provides access to the menu, or selection of parameters.

MENU

## Menu

Provides access to the main menu, or returns to the previous menu. To enter the menus, push this key and select the desired menu with  .

Menu 01  
Set

Settings for blast chilling.

Menu 02  
Store

Settings for storage.

Menu 03  
Program

Selection of programmes.

Menu 04  
Defrost

Defrosting.

Menu 05  
Set up

Programme settings.

Menu 06  
Clock setting

Setting the time and date.



Menu 07  
Memory

Programme memory.

Menu 08  
Alarm

Alarms.

<p>Menu 09 Print</p>	<p>Printing data.</p>
<p>Menu 10 Input/output</p>	<p>Inputs/outputs status.</p>
<p>Menu 11 Sterilization</p>	<p>No function at this product.</p>



**Up/down keys.**  
 Used for scrolling menus or changing parameter values.

**Start/stop.**  
 Process start/stop.

## Starting up

Connect the cabinet to mains power.



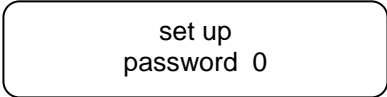

Push .

Then push , and select the desired menu with the   keys.

## Setting the language





Select **Menu 05**, and push  to enter the menu. The display shows: 

Default password: **-19**

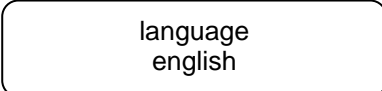
Select password with the up/down keys  , and press . Then push  to enter the main set up menu.

Select **Set Up 04**. Then push , and the first available language is displayed:





Use the up/down keys   for scrolling to the required language. Push  to confirm the selected language, or push  to return without any changes.

## Blast chilling

Select **Menu 01** to set and start a blast chilling process. Push  to access the settings for the blast chilling process.

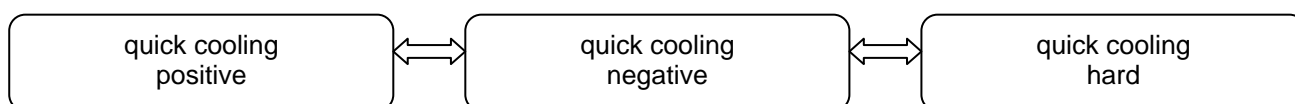

Selecting blastchilling/blast freezing:

Push  to change the settings flashing in the display, and scroll by pressing  :



Push  to select the desired process.

Selecting time controlled or temperature controlled chilling:

Use the up/down keys   to set time controlled or core temperature controlled chilling:

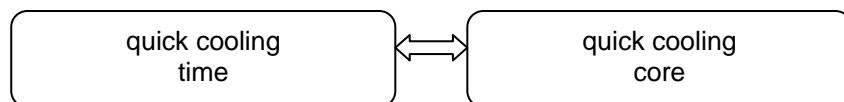



Setting the time, if time controlled chilling is selected:

length  
120 min

Setting the core temperature, if core temperature chilling is selected:

set point  
-25

Push  to start the selected process, or push  to exit the programme without starting the process.

**Note:** During a chilling process, it is possible to access **Menu 01** to view the settings, but they can not be changed during a running process.

The rate of chilling and freezing depends on the following factors:

- The form, type and material of containers in the cabinet.
- Whether or not the containers have lids.
- The properties of the food (density, water content, fat content).
- The temperature of the food at the beginning of chilling/freezing.
- The heat conductivity of the food.

The fast chilling/freezing time is also dependent on the way the food is handled. To facilitate fast chilling, the contents of a 1/1 GN pan should not exceed 3.5 kg, or contain a food layer thickness of more than 50 mm. When dealing with difficult and/or large items the layer thickness should be reduced further.



Place items of food in the blast chiller so that they are evenly distributed over the entire internal height of the cabinet. 1/1 GN pans should be placed as close to the blast section as possible, with the distance between them sufficient to allow suitable air circulation (about 25 mm).

## Storage programme



Select **Menu 02**, and push  to enter the storage menu.

Push  to change the settings. Use the up/down keys   to select cooling or freezing:

storing positive ↔ storing negative

Push  to select the desired programme. Use the up/down keys   to change the setpoint:

set point -1 ↔ set point -3

Push  to start the process, or push  to exit the programme.





## Using the programmes

It is possible to select user programmes that have been saved by the user, or select a number of preset programmes.

### User programmes:

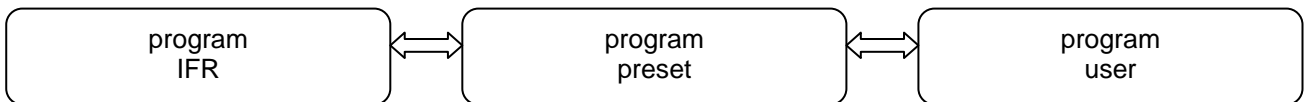

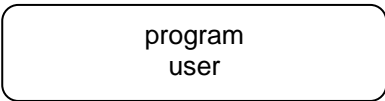

Select **Menu 03**, and push  to enter the menu:

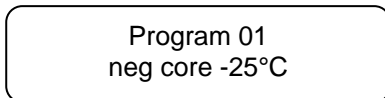

Select  and push  to enter the user programmes (01-20).



The display shows the programme number and the type of process saved:



Use the up/down keys   to select a programme. Push  to start the selected programme, or push  to exit the programme without starting the process.

Pressing  the programme is selected, and the controller enters the standby mode.

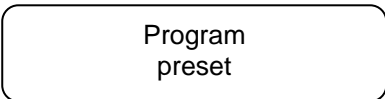
### Preset programmes

Select  and press  to enter the preset programmes (21-29).

Select the required programme with  . Push  to start the programme, or push  exit.

It is possible to select the following preset programmes:

Prog	Name	Positive/negative	Time/temperature	Hard	Room setpoint storing	Time
21	meat	positive	temperature	yes	+2°C	120 min.
22	dairy	positive	time	no	+2°C	90 min.
23	pie	positive	time	no	+2°C	90 min.
24	stew	positive	time	no	+2°C	90 min.
25	fish	positive	time	yes	+2°C	90 min.
26	poultry	positive	time	yes	+2°C	90 min.
27	vegetables	positive	time	no	+2°C	90 min.
28	freezing temp	negative	temperature	yes	-22°C	240 min.
29	freezing time	negative	time	yes	-22°C	240 min.

## Defrosting

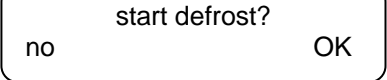
Select **Menu 04**, and push  to enter the menu. The display shows: 

The defrost cycle is started by pushing . To de-activate defrosting, push .





Push  to return to the main menu without starting the defrost cycle.

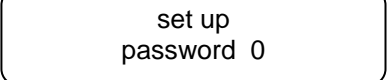

**Note:** The defrosting can be started directly from the main menu by pressing  for 5 seconds.



## Settings

Select **Menu 05**, and push  to enter the menu. The display shows: 

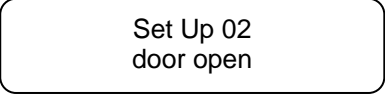
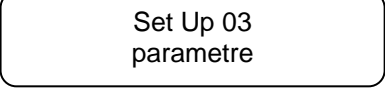
Default password: **-19**

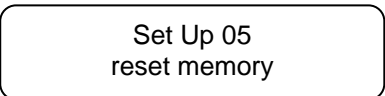
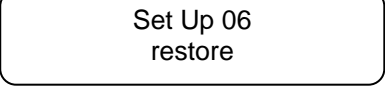
Select password with the up/down keys  , and press . Then push  to enter the main set up menu:

	Displaying the latest defrost cycles.
	Displaying recent door openings.
	Changing parameters.
	Setting the language.
	Reset of memory.
	Restore default parameters.

Use the up/down keys   to scroll the submenus. Select the desired menu by pushing .

Push  to return to the main menu.

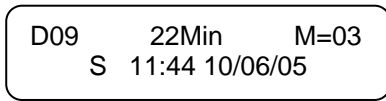

### Displaying the latest defrosting cycles:

Select **Set Up 01**. Then push  to see the recent 32 defrost cycles and the relating data. The display shows starting time and date, duration in minutes, and the defrost numbers in order from D01 to D32.



The M indicates the type of defrost start:

- M=01 Defrost started manually during storage.
- M=02 Periodic defrost during storage.
- M=03 Defrost started on the blast chilling starting.

Scrolling through the defrost cycles can be done by using the up/down keys  .



If there are no recorded data, the display shows: **No Date**.

Push  to return to the main menu.

### Displaying door openings:

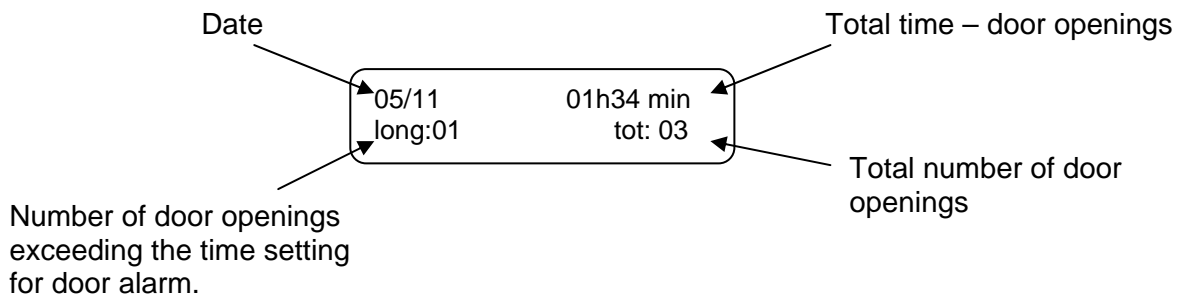
Select **Set Up 02**. Push  to display the recent door openings. The controller allows recording up to 31 days.





Use the up/down keys   to select the other dates of door opening.



Push  to return to the main menu.

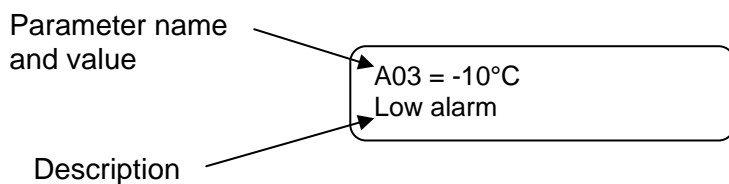

### Changing parameters:

Select **Set Up 03**. Then push  to enter setting of the parameters.



Use the up/down keys   to scroll the various parameters.

To change a parameter, push , and then use the up/down keys   to change the value.

Push  again to confirm the new value. Push  to return to the menu.

**Description of parameters:**

Parameter	Description	Default	Min.	Max.
<b>Blast chilling, positive</b>				
P01	Room temperature setpoint, soft	-5°C	-30°C	30°C
P02	Room temperature setpoint, hard	-25°C	-40°C	30°C
P03	Probe temperature setpoint, soft	3°C	-30°C	30°C
P04	Probe temperature setpoint, hard	20°C	-30°C	30°C
P05	Duration of the process	90 min	0 min	900 min
P06	Hard phase duration expressed in % relative to P05	60%	0%	100%
P07	Room temperature setpoint, storage	2°C	-30°C	30°C
<b>Blast chilling, negative</b>				
N01	Room temperature setpoint	-25°C	-40°C	30°C
N02	Probe temperature setpoint	-18°C	-30°C	30°C
N03	Duration of the process	240 min	0 min	900 min
N04	Room temperature setpoint, storage	-22°C	-40°C	30°C
<b>Alarms</b>				
A01	Temperature alarm hysteresis	2°C	0°C	10°C
A02	High temperature alarm, relative to P07	10°C	0°C	50°C
A03	Low temperature alarm, relative to P07	-10°C	-50°C	0°C
A04	High temperature alarm, relative to N04	10°C	0°C	50°C
A05	Low temperature alarm, relative to N04	-10°C	-50°C	0°C
A06	Temp.alarm delay from storage or defrost start	60 min	0 min	300 min
A07	Temp.alarm delay	30 min	0 min	300 min

For setting other parameters, refer to the operating- and servicemanual.  
If necessary, it can be ordered from your dealer.

**Reset of memory:**

Select **Set Up 05**. Push  to reset the memory:

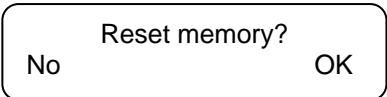



Push  to confirm the reset.

Push  to exit the menu without resetting the memory.

**Restore default parameters:**

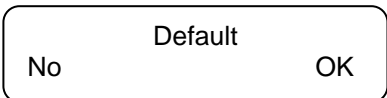
Push **Set Up 06**. Push  to enter the menu, the display shows:



Push  to restore the default parameters.





Push  to exit the menu.

## Setting the time and date

To set the time and date of the controller:

Select **Menu 06**, and push  to enter the menu. The display shows:





Date: 10/06/05  
Hour: 14:22:46

The flashing digit can be changed by using the keys  . Push  to save and enter the next digit. Press  to return to the main menu.

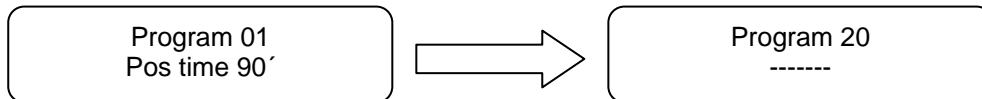
## Programme memory

Select **Menu 07**, and push  to enter the menu. The display shows the programme number, and indicates whether it is already saved or not:



Use the up/down keys   to scroll the programmes from 01 to 20. To save a programme, press the  key. To exit the programme without saving, push .

## Alarms

This is a menu for displaying memorized alarms. The controller is able to save up to 30 alarms with the relating data.

Select **Menu 08**, and push  to enter the menu.

If no alarms are saved, the display shows:



No date

The alarms are displayed in order from A01 to A30. Furthermore, the alarm starting time and date are displayed:

A05 Err room  
S 14:21 10/06/05

To display further alarm informations, push  : max or min temperature, duration, call service, time of de-activation, or if the alarm is still present:

A05 Err room  
Present

To scroll the alarm menu, use the up/down keys  .

Push  to return to the main menu.

## Printing data

**Note:** extra equipment is needed for this function.

Select **Menu 09**, and push  to enter the menu. The display shows:

No print data? Ok



Push  to print the data.

Push  to exit the menu without printing.

## Inputs/outputs

This menu displays the inputs/outputs state, e.g. the current sensor temperature values and state of the relays.

Select **Menu 10**, and push  to enter the menu.

To scroll the various data, use  .

Room -6°C  
Needle 15°C

Cabinet and probe temperature.

Evapor. -10°C  
Conden. 21°C

Evaporator and condenser temperature.



C D FE FC L R A  
1 0 0 1 1 0 0

Outputs:  
1= relay activated  
0= relay de-activated

DI1 DI2 FAN  
0 1 80

Digital inputs and evaporator fan speed.

## Fan speed

The evaporator fans are normally set at max. speed (100%). However it is possible to reduce the speed to 50%. By pushing  during the process, the current fan speed is displayed. The speed can be changed by pushing .

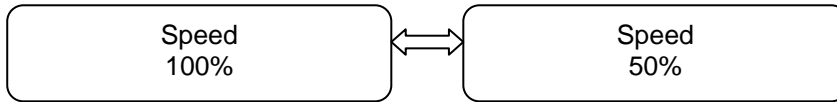

Push  to exit the programme.

## Cleaning



**Always disconnect the cabinet before cleaning.**

Do not flush compressor compartment and evaporator with water as this may cause short-circuits in the electrical system.

The cabinet should be cleaned internally with a mild soap solution at suitable intervals and checked thoroughly before it is put into operation again.

For the external maintenance – use stainless steel polish.



Cleansing agents containing chlorine or compounds of chlorine as well as other corrosive means, **may not be used**, as they might cause corrosion to the stainless panels of the cabinet and the evaporator system.

The compressor compartment and in particular the condenser must be kept free from dust and dirt. This is best done with a vacuum cleaner and a brush.

## Defrost water

Defrost water is led through a pipe in the insulation. The pipe leads to the back of the cabinet, where it has got an opening. A water seal must be established before the defrost water is led to a drain.

**Note!** It is important to keep the water seal clean, otherwise defrost water might flow back into the cabinet.

## Service

The refrigerating system need no inspection, only cleaning. If refrigeration fails, first investigate whether the unit has been unintentionally disconnected or switched off at the socket, or whether a fuse has blown.

If the cause of the refrigeration failure cannot be found, call the supplier of the unit giving its type and serial number.

Give the type name and part number. TYPE, SER.NO. and PART NO. are given on the type plate on the inside of the side panel.

Placement of the type plate:

### KPS 90

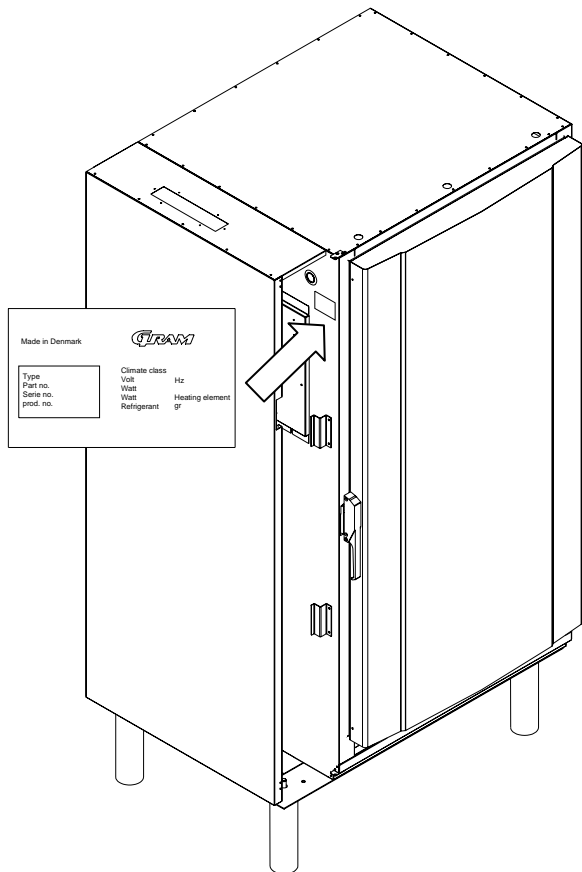

### KPS 60

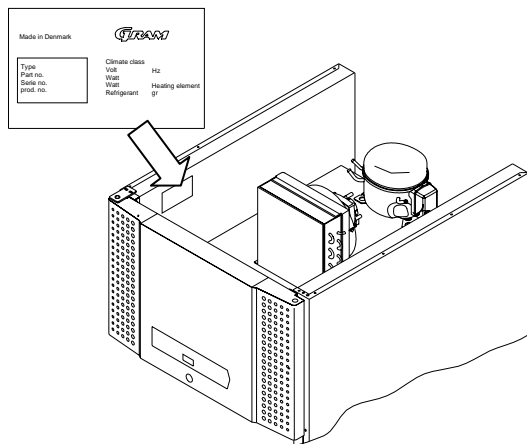

## Disposal

If the cabinet is to be disposed of, please do so in an environmentally correct way. There are special requirements/conditions to be observed.



# DEUTSCH

## Aufstellung

Der Schrank sollte in einem trockenen, gut belüfteten Raum stehen. Um einen wirtschaftlichen Betrieb sicherzustellen, muß die Aufstellung in direktem Sonnenlicht oder in der Nähe von Wärmequellen vermieden werden. Die Konstruktion des Schrankes erlaubt seinen Einsatz in einer Umgebungstemperatur bis zu +30°C.

Der Schrank muß senkrecht stehen. (Bei Schränken mit Beinen - Stellschrauben an den Beinen verwenden).

## Garantie und Wartung

### Garantie:

Die Garantie ist nur bei Einhaltung folgender Mindestforderungen gültig:

- 1) Das Kältesystem darf nur von autorisiertem Fachpersonal repariert werden.
- 2) Die elektrischen und elektronischen Teile dürfen nur von dazu autorisiertem Fachpersonal ausgetauscht werden.

### Warnung:

Ihr Kühl- oder Gefrierschrank wurde speziell für die Lagerung von Lebensmitteln und ähnlichen Waren konstruiert. Der Schrank darf nicht zur Aufbewahrung von Stoffen benutzt werden, die explosive Dämpfe/Gase freisetzen, da dadurch die Gefahr einer Explosion entstünde!

Alle Abschirmungen, die durch Warndreiecke und/oder Schrauben gesichert sind (z.B. an elektrischen Teilen, Heizelementen und beweglichen Teilen, wie z.B. Ventilatoren) dürfen nur von autorisiertem Fachpersonal nach Trennen des Schrankes vom Stromnetz gelöst werden.

Der Ein/Ausschalter am Paneel unterbricht nicht den Strom zu allen Komponenten des Schrankes. Ist der Schrank nur an diesem Schalter abgeschaltet, droht daher beim Öffnen der elektrischen Anlage Lebensgefahr! Ziehen Sie darum stets den Stecker aus der Netzsteckdose.

Um Eindringen von Wasser in die elektrischen Teile des Schrankes zu verhindern, darf bei der Reinigung kein Wasser direkt auf Bedienpaneel oder Kältesystem des Schrankes gespritzt werden.

## Stromanschluß

Netzanschluß 220-230 V /50 Hz an eine geerdete Steckdose (Schuko). Die übrigen Anschlußwerte gehen aus dem Typenschild hervor.

Bei Unklarheiten bezüglich des Anschlusses fragen Sie bitte ihren Lieferanten.

## Beschreibung der Bedientafel

Vor dem Einschalten des Schrankes ist die folgende Beschreibung der elektronischen Bedientafel sorgfältig zu lesen.

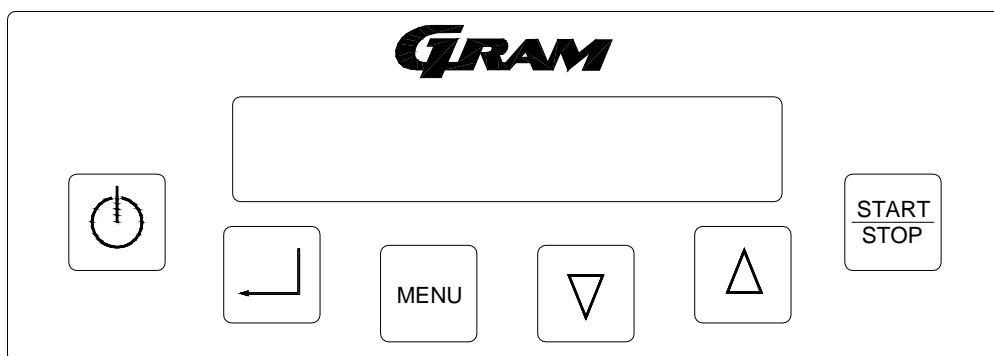

### Tasten:



#### Ein/Aus

Nach fünf Sekunden langem Druck auf  schaltet die Steuerung ab und das Display zeigt **OFF**. Ein zweiter Druck auf die Taste schaltet die Steuerung in den Bereitschaftszustand.



Im Servicefall:

Vor Servicearbeiten an den elektrischen Komponenten ist der Netzstecker zu ziehen. Es reicht **nicht** aus, den Schrank mit der Taste EIN/AUS abzuschalten, da bestimmte Teile der elektrischen Anlage weiterhin Spannung führen.





#### Eingabe

Springt in das Menü oder die Parameterwahl.



## Menü

Springt zum Hauptmenü oder in die vorherige Menüebene. Zum Zugriff auf die einzelnen Menüs, die taste drücken und das gewünschte Menü mit den Pfeiltasten wählen  .

Menu 01  
Set

Einstellungen zum Schockkühlen.

Menu 02  
Lagerung

Einstellungen zum Lagern.

Menu 03  
Programm

Programmwahl

Menu 04  
Abtauung

Start des Abtauvorgangs.

Menu 05  
Einstellen

Programmeinstellungen

Menu 06  
Uhr einstellen

Stellen der Uhr

Menu 07  
Speicherung

Programmspeicherung.

Menu 08  
Alarm

Alarめinstellungen

Menu 09  
Drucken

Ausdrucken von Daten.

Menu 10  
Eingang/Ausgang

Status der Eingänge und Ausgänge.

Menu 11  
Sterilisierung

Kein funktion in diesem Gerät.

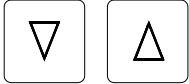

**Pfeiltasten auf/ab.**

Zum Blättern in Menüs oder zum Ändern von Werten.







**Start/Stop.**

Start / Stopp von Prozessen.

## Inbetriebnahme

Den Schrank vorschriftsmäßig an das Stromnetz anschließen.

Knopf  drücken.

Anschließend den Knopf  drücken und das gewünschte Menü mit den Pfeiltasten   wählen.





## Sprachwahl

**Menu 05** wählen und auf  drücken, um ins Menü zu gelangen.

Das Display zeigt:





Einstellung  
Passwort 0

Passwort ab Fabrik: **-19**

Passwort mit den Pfeiltasten   wählen und auf  drücken. Nun  drücken, um zum Programmieren ins Hauptmenü zu gelangen.

**Set Up 04** wählen. Danach  drücken. Es erscheint die erste Spracheinstellung im Display:

Sprache  
deutsch

Mit den Pfeiltasten   zur gewünschten Sprache blättern. Mit  die Wahl bestätigen oder mit  ohne Änderung der Spracheinstellung zurückspringen.

## Schockkühlen

**Menu 01** zum Einstellen und Starten des Abkühlprozesses wählen. Druck auf  gibt Zugriff auf die Einstellung des Abkühlvorgangs.

Wahl zwischen Schockkühlen/Schockgefrieren:

Nun auf  drücken, um die im Display blinkenden Einstellungen mit Hilfe der Pfeiltasten   zu ändern:

Schnellkühlen  
positiv

↔

Schnellkühlen  
negativ

↔

Schnellkühlen  
hard

Zur Wahl der gewünschten Einstellung auf  drücken.

Wahl zwischen zeit- oder temperaturgesteuertem Abkühlen:

Anschließend mit den Pfeiltasten   einstellen, ob nach Zeit oder Kerntemperatur gekühlt werden soll:

Schnellkühlen  
Zeit

↔



Schnellkühlen  
Kern

Für das zeitgesteuerte Abkühlen kann der Zeitraum eingestellt werden:

Dauer  
120 Min.

Im anderen Fall kann die Kerntemperatur eingestellt werden:

Einstellpunkt  
-25

Mit  wird der gewählte Prozess gestartet, mit  ohne Start des Prozesses das Programm verlassen.

**ACHTUNG:** Während des Abkühlvorgangs können Sie in **Menu 01** hinein sehen, um die Einstellungen zu prüfen, aber im laufenden Programm können die Einstellungen nicht verändert werden.

Die Abkühl- und Gefriereschwindigkeit hängt von folgenden Gegebenheiten ab:



- Schichtdicke der Lebensmittel sowie Form, Typ und Material der Behälter.
- Menge und Zusammensetzung der Lebensmittel
- Behälter mit oder ohne Deckel
- Temperatur der Lebensmittel zu Beginn des Abkühl-/Gefriervorgangs
- Wärmeleiteigenschaften der Lebensmittel

Die Dauer des Abkühl-/Gefriervorgangs ist außerdem von der Art der Lebensmittel abhängig. Mit Rücksicht auf die Abkühlzeit darf der Inhalt pro 1/1 GN-Kantine 3,5 kg oder eine Schichtdicke von 50 mm nicht übersteigen. Bei der Behandlung schwieriger oder großer Waren ist die Schichtdicke zusätzlich zu reduzieren.



Die Lebensmittel in den Schockkühler einlegen, gleichmäßig über die Innenhöhe des Schanks verteilt. Die 1/1 GN-Kantinen möglichst nahe beim Lüfter und mit Zwischenräumen voneinander platzieren, die passende Luftzirkulation ermöglichen (ca. 25 mm).

## Lagerprogramm

**Menu 02** wählen und auf  drücken, um ins Menü zu gelangen.

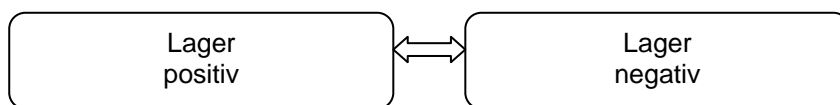
 zum Ändern der Einstellungen drücken. Mit den Pfeiltasten   zwischen Kühlen und Gefrieren wählen:



Zur Wahl des gewünschten Programms auf  drücken. Mit den Pfeiltasten   den Einstellpunkt ändern:

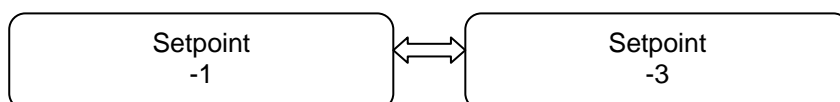

Mit  das gewählte Programm starten oder mit  das Programm verlassen.

## Einsatz der Programme

Es können selbst gespeicherte Anwenderprogramme oder voreingestellte Programme gewählt werden.

Anwenderprogramme:



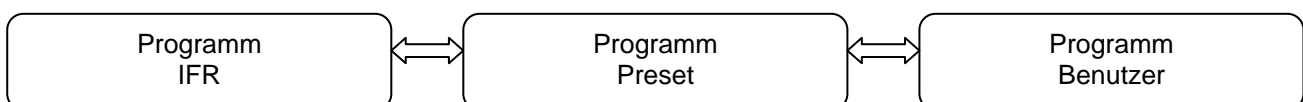

**Menu 03** wählen und auf  drücken, um ins Menü zu gelangen:

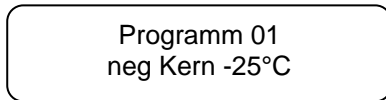

wählen und  drücken, um in die Anwenderprogramme zu gelangen(01-20).

Das Display zeigt die Programmnummer und den gespeicherten Prozess:





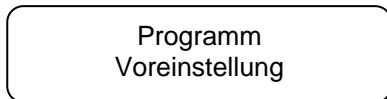

Mit den Pfeiltasten   das Programm wählen. Mit  das gewählte Programm starten oder mit  das Programm verlassen, ohne den Prozess zu starten.

Mit  wird das betreffende Programm gewählt, und der Schrank geht in Bereitschaftszustand.

### Voreingestellte Programme:



wählen und auf  drücken, um in die fest voreingestellten Programme zu gelangen (21-29).

Das gewünschte Programm mit   suchen. Mit  das gewählte Programm starten oder mit  das Programm verlassen.

Folgende Programme stehen zur Wahl:

Prog	Name	Positiv/ Negativ	Zeit/Temperatur	Hard	Raumtemp. Sollwert Lager	Zeit
21	fleisch	positiv	Temperatur	ja	+2°C	120 min.
22	molkerei	positiv	Zeit	nein	+2°C	90 min.
23	kuchen	positiv	Zeit	nein	+2°C	90 min.
24	eintoepfe	positiv	Zeit	nein	+2°C	90 min.
25	fisch	positiv	Zeit	ja	+2°C	90 min.
26	geflügel	positiv	Zeit	ja	+2°C	90 min.
27	gemüse	positiv	Zeit	nein	+2°C	90 min.
28	Gefriertemp.	negativ	Temperatur	ja	-22°C	240 min.
29	Gefrierzeit	negativ	Zeit	ja	-22°C	240 min.

## Abtauen

**Menu 04** wählen und auf  drücken, um ins Menü zu gelangen.

Das Display zeigt:

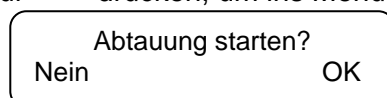

Abtauen starten mit . Zum Deaktivieren des Abtauvorgangs  drücken.

Mit  ohne Abtauen ins Menü zurückkehren.





**ACHTUNG:** Das Abtauen kann direkt aus dem Hauptmenü aktiviert werden, durch Druck auf  für 5 Sekunden.

## Einstellungen

**Menu 05** wählen und auf  drücken, um ins Menü zu gelangen.

Das Display zeigt:

Einstellung  
Passwort 0

Passwort mit den Pfeiltasten   wählen und auf  drücken. Nun  drücken, um zum Programmieren ins Hauptmenü zu gelangen:

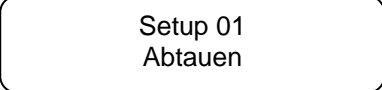
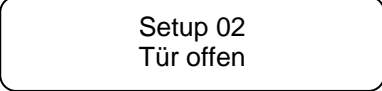
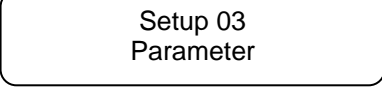
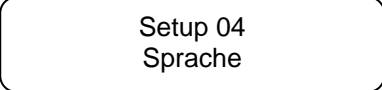
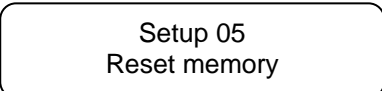
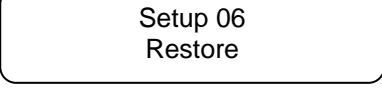
	Zeigt die letzten Abtauvorgänge an.
	Zeigt die letzten Türöffnungen an.
	Parameteränderung
	Sprachwahl.
	Löscht den Speicherinhalt.
	Setzt alle Werte auf Werkseinstellungen zurück.

Mit den Pfeiltasten   das Untermenü wählen. Das gewünschte Untermenü mit  wählen.

Mit  zum Hauptmenü zurückkehren.



### Anzeige der letzten Abtauvorgänge:

**Set Up 01** wählen. Anschließend auf  drücken, um die letzten 32 Abtauvorgänge mit den zugehörigen Daten anzuzeigen. Das Display zeigt Startzeit und Datum, Dauer des Abtauens in Minuten sowie die Reihenfolge von D01 bis D32 an.

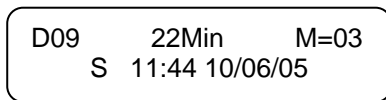



M gibt an, wie der Abtauvorgang gestartet wurde:

M=01 Abtauen manuell aus dem Lagerkühlprogramm gestartet.

M=02 Automatisches Abtauen aus dem Lagerkühlprogramm.

M=03 Abtauen bei Start des Abkühlprozesses.

Mit   können Sie in den Abtauvorgängen blättern.

Sind keine Abtauvorgänge gespeichert, zeigt das Display **Keine Daten**.



Mit  zum Hauptmenü zurückkehren.

### Anzeige von Türöffnungen:

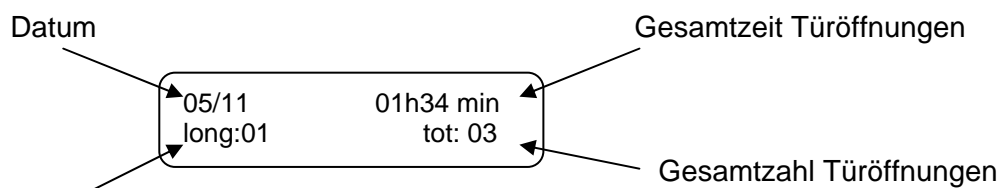
**Set Up 02 wählen**. Danach auf  drücken, um die letzten Türöffnungen anzuzeigen. Die Steuerung speichert Türöffnungen bis zu 31 Tage lang.



Anzahl der Türöffnungen, die den Zeitraum für den Türalarm überstiegen.



Mit den Pfeiltasten   wählen Sie die anderen Daten von Türöffnungen.



Mit  zum Hauptmenü zurückkehren.

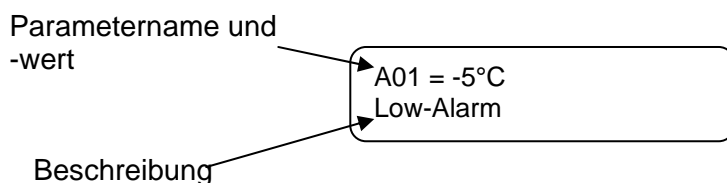

### Parameteränderung:

**Set Up 03** wählen. Anschließend  drücken, um die Parameter ändern zu können.



Mit den Pfeiltasten   können Sie in den unterschiedlichen Parametern blättern.

Zum Ändern eines Parameters  drücken und den Wert dann mit den Pfeiltasten   ändern.

Nochmals  zur Bestätigung des neuen Werts drücken. Mit  zum Hauptmenü zurückkehren.

### Parameterübersicht:

Parameter	Beschreibung	Werks-einstellung	Min.	Max.
<b>Schockkühlen, plus</b>				
P01	Raumtemperatur-Einstellpunkt, soft	-5°C	-30°C	30°C
P02	Raumtemperatur-Einstellpunkt, hart	-25°C	-40°C	30°C
P03	Spießtemperatur-Einstellpunkt, soft	3°C	-30°C	30°C
P04	Spießtemperatur-Einstellpunkt, hart	20°C	-30°C	30°C
P05	Prozessdauer	90 min	0 min	900 min
P06	Länge der harten Phase in % relativ zu P05	60%	0%	100%
P07	Raumtemperatur-Einstellpunkt, Lager	2°C	-30°C	30°C
<b>Schockkühlen, minus</b>				
N01	Raumtemperatur-Einstellpunkt	-25°C	-40°C	30°C
N02	Spießtemperatur-Einstellpunkt	-18°C	-30°C	30°C
N03	Prozessdauer	240 min	0 min	900 min
N04	Raumtemperatur-Einstellpunkt, Lager	-22°C	-40°C	30°C
<b>Alarme</b>				
A01	Temperaturalarm-Hysterese	2°C	0°C	10°C
A02	Oberer Temperaturalarm, relativ zu P07	10°C	0°C	50°C
A03	Unterer Temperaturalarm, relativ zu P07	-10°C	-50°C	0°C
A04	Oberer Temperaturalarm, relativ zu N04	10°C	0°C	50°C
A05	Unterer Temperaturalarm, relativ zu N04	-10°C	-50°C	0°C
A06	Temp.-Alarmverzögerung von Lager oder Abtaustart	60 min	0 min	300 min
A07	Temp.-Alarmverzögerung	30 min	0 min	300 min

Zur Einstellung der übrigen Parameter ziehen Sie bitte die Bedienungs- und Serviceanleitung zu Rate.

Sie bekommen Sie auf Wunsch von Ihrem Händler.

### Zurücksetzen des Speicherinhalts:

**Set Up 05** wählen. Mit  den Speicher zurücksetzen.

Mit  den Vorgang bestätigen.

Mit  das Menü ohne Speicherlöschen verlassen.

Reset memory?

No
OK

## Alle Werte auf Werkseinstellungen zurücksetzen:

**Set Up 06** wählen. Mit  ins Menü springen, das Display zeigt:

No	Default	OK
----	---------	----

Mit  die Standardeinstellungen wiederherstellen.

Mit  das Menü verlassen.





## Einstellen von Datum und Uhrzeit

Datum und Uhrzeit der Steuerung werden folgendermaßen eingestellt:

**Menu 06** wählen und auf  drücken, um ins Menü zu gelangen.

Das Display zeigt:





Datum:	10/06/05
Stunde:	14:22:46

Die blinkende Ziffer kann jeweils mit den Pfeiltasten   geändert werden. Mit  speichern und zur nächsten Ziffer springen. Mit  zum Hauptmenü zurückkehren.

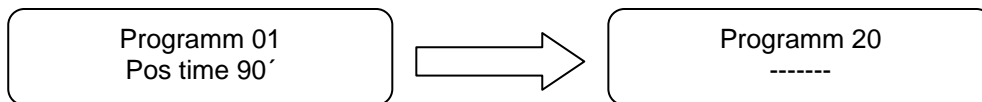
## Programmspeicherung

**Menu 07** wählen und auf  drücken, um ins Menü zu gelangen. Das Display zeigt die Programmnummer, und ob das Programm gespeichert wurde.



Mit den Pfeiltasten   die Programme von 01 bis 20 durchsehen. Zum Speichern eines Programms,  drücken. Das Programm ohne Speicherung verlassen durch Drücken auf .

## Alarme

Die Steuerung speichert aufgetretene Alarme, und in diesem Menüpunkt können sie angezeigt werden. Der Speicher kann bis zu 30 Alarme aufnehmen.

**Menu 08** wählen und auf  drücken, um ins Menü zu gelangen.

Wenn keine Alarme gespeichert wurden, zeigt das Display:



No date
---------

Das Display zeigt die Alarmer in der Reihenfolge A01 bis A30. Außerdem werden der Zeitpunkt des Alarmstarts und das Datum angezeigt.

A05 Err room  
S 14:21 10/06/05

Ein Druck auf  holt die übrigen Informationen zu dem Alarmtyp: Maximal- oder Minimaltemperatur, Dauer, Kundendienst rufen, Zeitpunkt der Quittierung bzw. ob der Alarm noch aktiv ist:

A05 Err room  
Vorhanden

Mit den Pfeiltasten   kann im Alarmmenü geblättert werden.

Mit  zum Hauptmenü zurückkehren.

## Ausdrucken von Daten

**Anmerkung:** Extraausrüstung ist für diese Funktion erforderlich.

**Menu 09** wählen und auf  drücken, um ins Menü zu gelangen.

Das Display zeigt:

Daten drucken?  
Nein Ok

Zum Drucken der Daten  drücken.

Mit  das Menü ohne Drucken verlassen.

## Ein- und Ausgänge

Dieses Menü zeigt die aktuellen Werte für Ein- und Ausgänge, z.B. die aktuellen Temperaturen der Fühler und den Status der Relais.

**Menu 10** wählen und auf  drücken, um ins Menü zu gelangen.

Mit den Pfeiltasten   können Sie in den Daten blättern:

Raum -6°C  
Spieß 15°C

Raum- und Spießtemperatur

Verdampfer -10°C  
Konden. 21°C

Verdampfer- und Kondensatortemperatur



C D FE FC L R A  
1 0 0 1 1 0 0

Outputs:  
1= Relais aktiviert  
0= Relais nicht aktiviert

DI1 DI2 FAN  
0 1 80

Digitale Inputs und Verdampferlüftergeschwindigkeit.

## Lüftergeschwindigkeit

Die Lüfter sind auf 100% Geschwindigkeit voreingestellt. Die Geschwindigkeit kann jedoch auf 50% reduziert werden. Ein Druck auf  bei laufendem Prozess zeigt die aktuelle Geschwindigkeit. Die Geschwindigkeit kann mit  geändert werden.

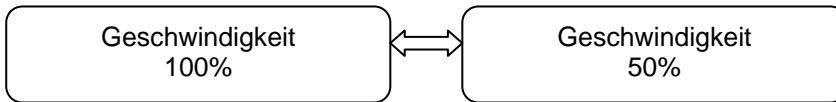

Mit  das Programm verlassen.

## Reinigung



**Zur Reinigung ist der Schrank auszuschalten.**

Kompressorraum und Kühlelement dürfen nicht mit Wasser abgespritzt werden, da dies zu Kurzschlüssen oder anderen Schäden an der elektrischen Anlage führen kann.

In geeigneten Abständen ist das Gerät innen und außen mit einer schwachen Seifenlösung zu reinigen und gründlich zu kontrollieren, bevor es wieder eingeschaltet wird.

Die äußere Oberfläche kann mit einem Pflegespray für Edelstahl instandgehalten werden.



Reinigungsmittel, die Chlor oder Chlorverbindungen, sowie andere aggressive Stoffe enthalten **dürfen nicht verwendet werden**, da sie zu Korrosion an den rostfreien Flächen und der inneren Kälteanlage führen können.

Der Kompressorraum und speziell der Kondensator sind von Schmutz und Staub frei zu halten, wozu ein Staubsauger und eine steife Bürste gut geeignet sind.  
Vermerken Sie die Reinigung des Kondensators evtl. im Reinigungsplan.

## Tauwasser

Das Tauwasser wird durch ein Rohr in der Isolierung geleitet. Das Rohr kommt auf der Hinterseite des Schrankes aus. Ein Siphon muß installiert werden, ehe das Tauwasser in einen Abflußkanal geleitet wird.

**BITTE BEACHTEN:** Der Siphon ist sauber zu halten, da das Tauwasser sonst in den Schrank zurück laufen kann.

## Service

Das Kühlsystem und der hermetisch verschlossene Verdichter benötigen keine Pflege - sie müssen nur sauber gehalten werden. Das Frontpaneel kann nach oben geschoben und entfernt werden. Bei mangelnder Kälteleistung sollten Sie zuerst untersuchen, ob ein unbeabsichtigtes Herausziehen des Netzsteckers oder eine Spannungsunterbrechung an der Sicherung die Ursache ist.

Kann kein Grund für nachlassende Kälteleistung gefunden werden, wenden Sie sich bitte an Ihren Lieferanten. Geben Sie dabei bitte die Typenbezeichnung des Schrankes und die Teilenummer an. TYPE, SER.NO und PART NO finden Sie auf dem Typenschild.

Plazierung des Typenschilds:

### KPS 90

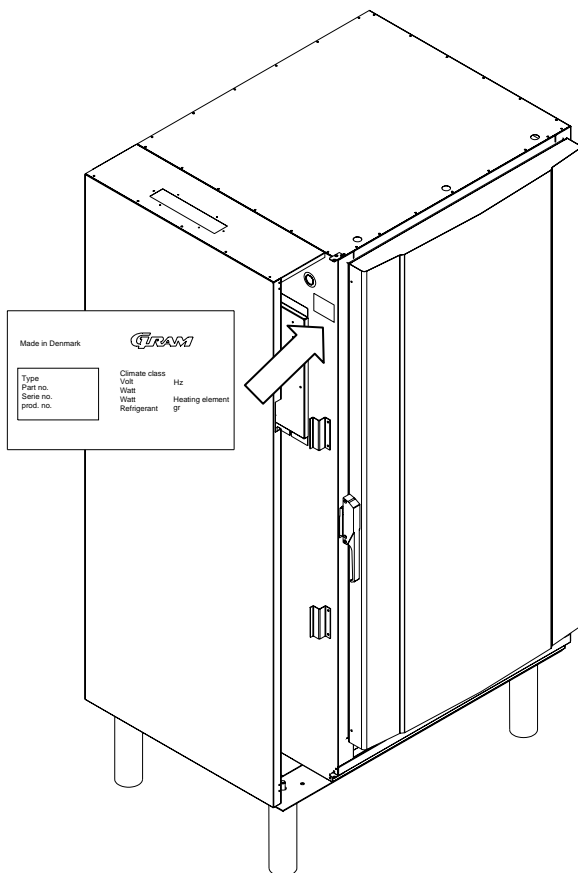

### KPS 60

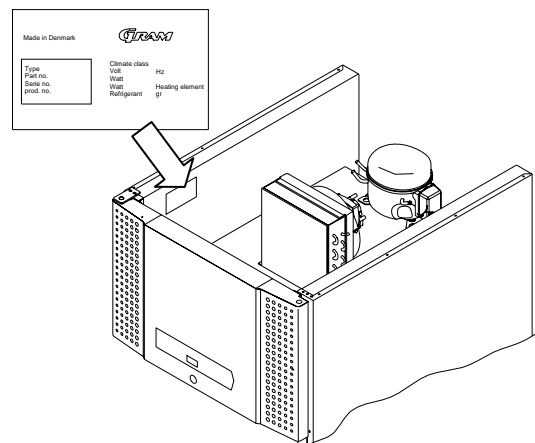

## Entsorgung

Das ausgediente Gerät ist auf umweltgerechte, ordnungsgemäße Weise zu entsorgen. Beachten Sie die entsprechenden geltenden Bestimmungen für die Entsorgung. Es können bestimmte Vorschriften/Bedingungen gelten, die einzuhalten sind.

# NEDERLANDS

## Opstellen/Plaatsen

De kast bij voorkeur plaatsen in een droge en goed geventileerde ruimte. Om verzekerd te zijn van een goede werking, de kast niet opstellen in de directe zon of pal naast warmtebronnen (maximale omgevingstemperatuur +40°C.)

## Garantie en voorwaarden

### Garantie:

De garantie geldt slecht indien aan een aantal minimale voorwaarden wordt voldaan, te weten:

- 1) Het koelsysteem mag alleen door "stek" erkende monteurs worden behandeld.
- 2) Levensmiddelen welke zure dampen uitscheiden dienen in de koelkast afgedekt te worden bewaard teneinde aantasting van onderdelen in de kast te voorkomen.
- 3) Elektrische en elektronische controles mogen alleen door erkende monteurs worden uitgevoerd.

### N.B.:

Uw koeler of vriezer is ontworpen voor het bewaren van levensmiddelen en dergelijke. De kast mag niet worden gebruikt voor producten welke explosieve gassen kunnen afscheiden daar dan het risico van explosie ontstaat. Op plaatsen waar u een waarschuwingsdriehoek aantreft mag de beschermkap of bevestiging pas worden losgemaakt wanneer de kast geheel spanningsvrij is. (Stekker uit het stopcontact). De aan/uit schakelaar op kast maakt de besturingscomponenten niet spanningsvrij.

Om zeker te zijn dat geen water doordringt tot elektrische componenten dient er op te worden gelet tijdens schoonmaken dat geen water wordt gespoten tegen of onder het besturingspaneel of bij de compressorruimte.

## Elektrische aansluiting

De elektrische aansluitspanning is op het type-plaatje aangegeven en bedraagt 220-230 Volt 50 perioden (+ randaarde). Het opgenomen vermogen is eveneens op het type-plaatje aangegeven, dit in verband met de keuze van de juiste zekering.

## Beschrijving van het bedieningspaneel

Voordat u de kast in gebruik neemt, dient u onderstaande beschrijving van de regelfuncties van het elektronische bedieningspaneel grondig door te nemen.

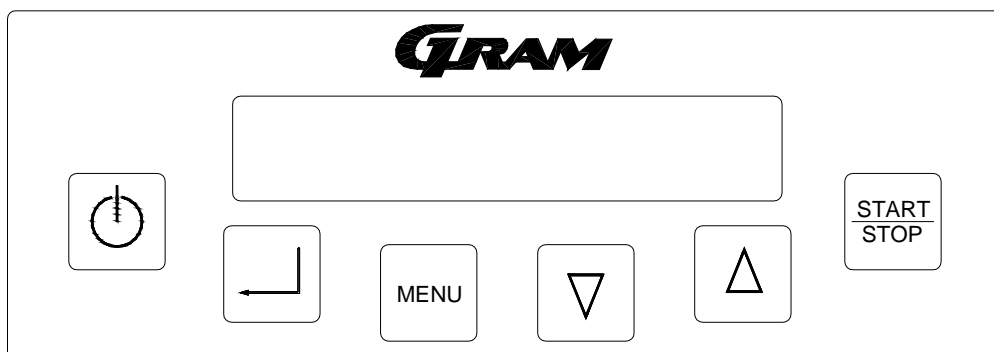

### Toetsen:



#### **On/off**

Door 5 seconden op  te drukken zet men de regeling uit en op het display verschijnt **OFF**. Door nogmaals op de toets te drukken, zet men de regeling op stand-by gezet.



#### **Bij service:**

Als er service op de elektrische delen wordt uitgevoerd, moet de stekker uit het stopcontact gehaald worden. Het is **niet** voldoende om de kast met de ON/OFF toets van het regelpaneel uit te zetten, aangezien er dan nog altijd spanning op de elektrische delen van de kast zal staan.





#### **Enter**

Biedt toegang tot het menu of tot parameters kiezen.



#### **Menu**

Biedt toegang tot het hoofdmenu of gaat terug naar het vorige menu. Druk op de toets voor toegang tot de verschillende menu's en kies het gewenste menu met behulp van de pijltoetsen  .



Menu 01 Set	Instellingen voor ventilatorkoeling.
Menu 02 Opslaan	Instellingen voor opslaan.
Menu 03 Programma	Programma's kiezen.
Menu 04 Ontdooien	Ontdooiproces starten.
Menu 05 Parameters	Programmainstellingen.
Menu 06 Klok instellen	Klok instellen.
Menu 07 Geheugen	Programma's opslaan.
Menu 08 Alarm	Alarminstellingen.
Menu 09 Printen	Gegevens uitdraaien
Menu 10 Ingang/uitgang	Status voor ingangen en uitgangen.
Menu 11 Sterilisatie	Geen functie op dit product.



### Pijltjestoetsen op/neer.

Wordt gebruikt om de menu's door te lopen of de waarden te veranderen.





### Start/stop.

Start / stop van proces.

## Inbedrijfstelling

Sluit de kast correct op de stroom aan.

Druk op de  knop.





Druk daarna op de  knop en kies het gewenste menu met behulp van de pijltjestoetsen  .

## Taal kiezen

Kies **Menu 05** en druk op  om in het menu te komen.

Default wachtwoord: **-19**





Op het display verschijnt: 

Kies wachtwoord met behulp van de pijltjestoetsen   en druk op . Druk nu op  om in het hoofdmenu te komen om te programmeren:

### Taal kiezen

Kies **Set Up 04**. Druk daarna op  waarna de eerste taalinstelling op het display verschijnt:



Gebruik de pijltjestoetsen   om naar de gewenste taal te lopen. Druk op  om de taalkeus te bevestigen, of druk op  om het programma te verlaten zonder de taalinstelling te wijzigen.

## Ventilatorkoeling

Kies **Menu 01** om het afkoelproces in te stellen en te starten. Druk op  om toegang te krijgen tot het koelproces instellen.

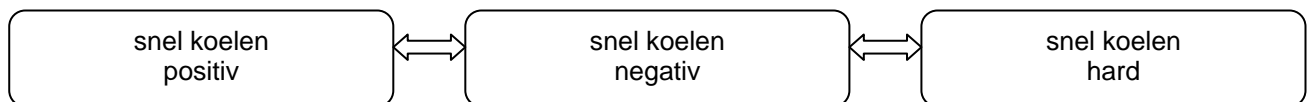

Ventilatorkoelen/-vriezen kiezen:

Druk nu op  om de instellingen die dan in het display knipperen te wijzigen met behulp van de pijltjestoetsen   :



Druk op  om de gewenste instelling te kiezen.

Tijdgestuurde of temperatuurgestuurde afkoeling kiezen:

Gebruik de pijltjestoetsen   om in te stellen of er op tijd of kerntemperatuur gewerkt moet worden:

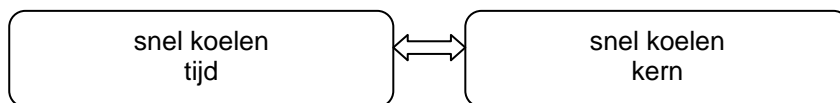

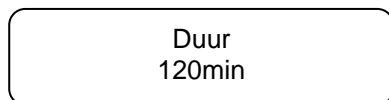

De tijd is in te stellen als voor tijdgestuurde afkoeling gekozen wordt.

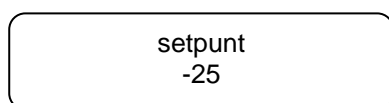

De temperatuur is in te stellen als voor kerntemperatuursturing gekozen wordt.



Druk op  om het gekozen proces te starten of druk op  om het programma te verlaten zonder het proces te starten.

NB: Tijdens het afkoelproces is het mogelijk om naar **Menu 01** te gaan om de instellingen te bekijken, maar ze zijn niet te wijzigen zolang het proces in werking is.

De afkoel- en invriessnelheid is van de volgende factoren afhankelijk:



- De dikte van het product en de vorm, het type en materiaal van de bak die gebruikt wordt.
- De hoeveelheid en samenstelling van het product
- Bakken met of zonder deksel
- De temperatuur van de producten net voor het afkoelen/invriezen
- Het warmtegeleidingsvermogen van de producten

De duur van het snel afkoelen / invriezen is tevens afhankelijk van het type product. Wat de afkoelduur betreft mag de inhoud van 1/1 GN-bak niet meer dan 3,5 kg zijn of een laagdikte van meer dan 50 mm hebben. Bij het behandelen van moeilijke en/of grote producten, moet de laagdikte nog dunner worden.



Plaats de producten in de blaaskoeler zodanig dat ze regelmatig over heel de inwendige hoogte van de kast verdeeld worden. 1/1 GN-bakken worden zo dicht mogelijk bij de blaassectie gezet en de onderlinge afstand moet groot genoeg zijn voor voldoende luchtcirculatie (ca. 25 mm).

## Opslagprogramma

Kies **Menu 02** en druk op  om in het menu te komen.

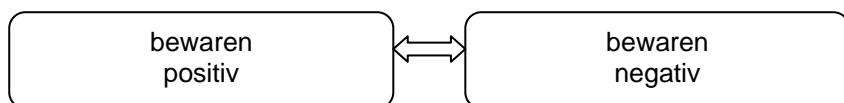
Druk op  om de instellingen te wijzigen. Gebruik de pijltjestoetsen   om koelen of vriezen te kiezen:



Druk op  om het gewenste programma te kiezen. Gebruik de pijltjestoetsen   om het setpunt te wijzigen.

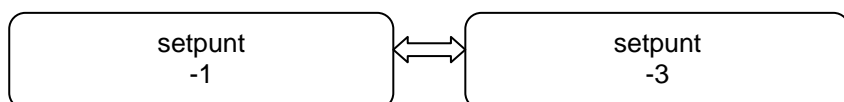

Druk op  om het gekozen programma te starten of druk op  om het programma te verlaten.

## De programma's gebruiken

Het is mogelijk gebruikersprogramma's te gebruiken, die men zelf gekozen heeft of tussen een aantal vast ingestelde programma's te kiezen.

### Gebruikersprogramma's:



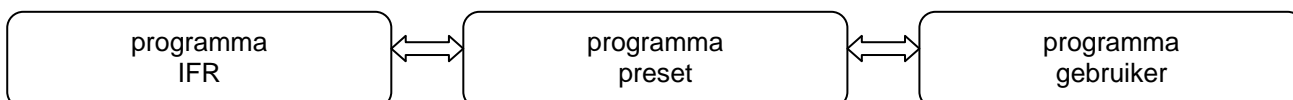

Kies **Menu 03** en druk op  om in het menu te komen.

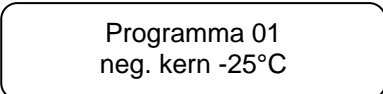

Kies  en druk op  om in de gebruikersprogramma's (01-20) te komen.





Het display toont het programmanummer en welk type proces er opgeslagen is:



Gebruik de pijltjestoetsen   om het programma te kiezen. Druk op  om het gekozen programma te starten, of druk op  om het programma te verlaten zonder het proces te starten. Door op  te drukken kiest u het desbetreffende programma en de kast zal in stand-by gaan.

### Vast ingestelde programma's:

Kies  en druk op  om in de vast ingestelde programma's (21-29) te komen.

Zoek het gewenste programma met behulp van  . Druk op  om het gekozen programma te starten, of druk op  om het programma te verlaten.

Er is tussen de volgende programma's te kiezen:

Prog	Beschrijving	Positiv/negativ	Tijd/temperatuur	Hard	Setpoint bij conservering	Tijd
21	vlees	positiv	temperatuur	ja	+2°C	120 min.
22	zuivel	positiv	tijd	nee	+2°C	90 min.
23	pate	positiv	tijd	nee	+2°C	90 min.
24	maaltijdsoepen	positiv	tijd	nee	+2°C	90 min.
25	vis	positiv	tijd	ja	+2°C	90 min.
26	gevogelte	positiv	tijd	ja	+2°C	90 min.
27	groente	positiv	tijd	nee	+2°C	90 min.
28	vriestemperatuur	negativ	temperatuur	ja	-22°C	240 min.
29	vriestijd	negativ	tijd	ja	-22°C	240 min.

## Ontdooien

Kies **Menu 04** en druk op  om in het menu te komen.

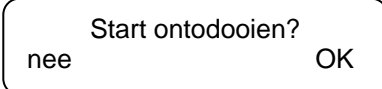
Op het display verschijnt: 

Start het proces door op  te drukken. Druk op  om het ontdooien uit te schakelen.





Druk op  om terug naar het menu te gaan zonder het ontdooien te starten.

NB: Het ontdooien is direct vanuit het hoofdmenu te activeren door 5 seconden op  te drukken.





# Instellingen

Kies **Menu 05** en druk op  om in het menu te komen.

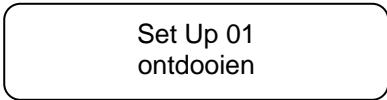
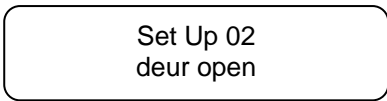
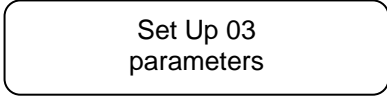
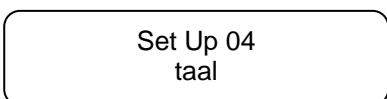
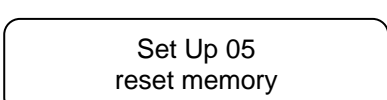
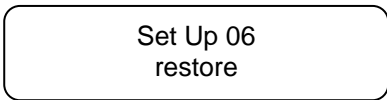
Op het display verschijnt: 

Kies wachtwoord met behulp van de pijltjestoetsen   en druk op . Druk nu op  om in het hoofdmenu te komen om te programmeren:

	Toont de laatste ontgooiingen.
	Toont de laatste deuropeningen.
	Parameters wijzigen.
	Taal kiezen.
	Geheugen resetten
	Waarden naar de fabrieksinstelling resetten.

Gebruik de pijltjestoetsen   om de submenu's te kiezen. Kies het gewenste submenu met . Druk op  om terug naar het hoofdmenu te gaan.

## **De laatste ontgooiingen tonen:**

Kies **Set Up 01**. Druk daarna op  om de laatste 32 ontgooiprocessen en de bijbehorende gegevens te bekijken. Het display toont de starttijd en datum, ontgooi-duur in minuten en de volgorde van D01 tot D32.

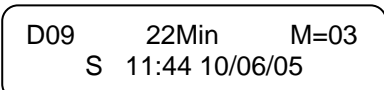



D09 22Min M=03  
S 11:44 10/06/05

M geeft aan wanneer het ontdooien gestart is:

M=01 Het handbediend ontdooien tijdens opslagkoeling gestart.

M=02 Periodiek ontdooien tijdens opslagkoeling.

M=03 Ontdooien gestart aan het begin van het afkoelproces.

Het is mogelijk de ontdooiingen door te lopen met behulp van  .



Als er geen ontdooiingen opgeslagen zijn, toont het display **No Date**.

Druk op  om terug naar het hoofdmenu te gaan.

### Tonen van deuropeningen:

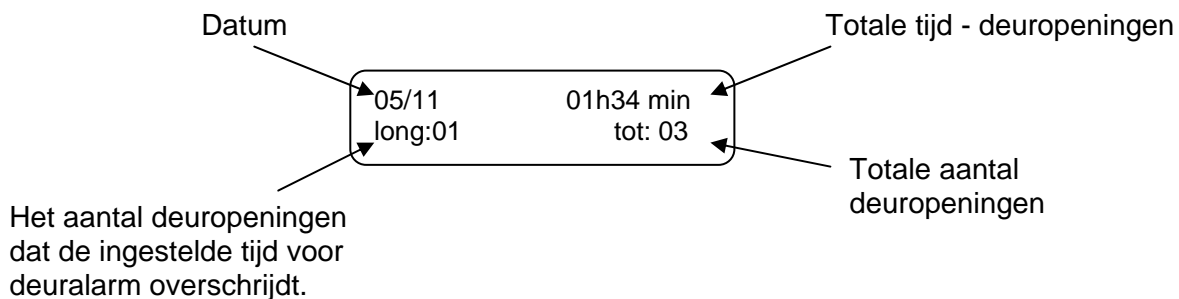
Kies **Set Up 02**. Druk daarna op  om de laatste deuropeningen te bekijken. De sturing bewaart de deuropeningen tot 31 dagen.





Gebruik de pijltjestoetsen   om de overige datums voor deuropening te kiezen.

Druk op  om terug naar het hoofdmenu te gaan.

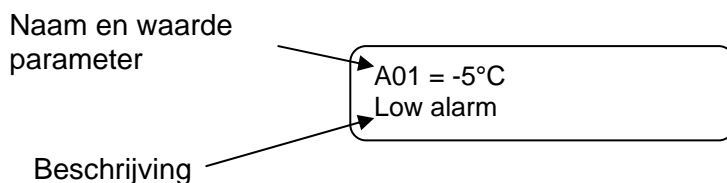

### Parameters wijzigen:

Kies **Set Up 03**. Druk daarna op  om toegang te krijgen tot parameters instellen.



Gebruik de pijltjestoetsen   om de verschillende parameters door te lopen.

Druk op  om een parameter te wijzigen en gebruik de pijltjestoetsen   om de waarden te wijzigen.

Druk nogmaals op  om de nieuwe waarde te bevestigen. Druk op  om terug naar het menu te gaan.

Overzicht over parameters:

Parameter	Beschrijving	Fabr. instelling	Min.	Max.
<b>Ventilatorkoeling, plus</b>				
P01	Ruimtetemperatuur setpunt, soft	-5°C	-30°C	30°C
P02	Ruimtetemperatuur setpunt, hard	-25°C	-40°C	30°C
P03	Kerntemperatuur setpunt, soft	3°C	-30°C	30°C
P04	Kerntemperatuur setpunt, hard	20°C	-30°C	30°C
P05	Duur van het proces	90 min	0 min	900 min
P06	Harde fase lengte in % relatief tot P05	60%	0%	100%
P07	Ruimtetemperatuur setpunt, opslag	2°C	-30°C	30°C
<b>Ventilatorkoeling, minus</b>				
N01	Ruimtetemperatuur setpunt	-25°C	-40°C	30°C
N02	Kerntemperatuur setpunt	-18°C	-30°C	30°C
N03	Duur van het proces	240 min	0 min	900 min
N04	Ruimtetemperatuur setpunt, opslag	-22°C	-40°C	30°C
<b>Alarmen</b>				
A01	Temperatuuralarm hysteresis	2°C	0°C	10°C
A02	Hoogste temperatuuralarm, relatief tot P07	10°C	0°C	50°C
A03	Laagste temperatuuralarm, relatief tot P07	-10°C	-50°C	0°C
A04	Hoogste temperatuuralarm, relatief tot N04	10°C	0°C	50°C
A05	Laagste temperatuuralarm, relatief tot N04	-10°C	-50°C	0°C
A06	Temp.alarm vertraging van opslag of start ontdooien	60 min	0 min	300 min
A07	Temp.alarm vertraging	30 min	0 min	300 min

Voor het instellen van de overige parameters wordt naar de Bedienings- en servicehandleiding verwezen.

Deze is indien nodig bij uw handelaar te verkrijgen.

**Geheugen resetten.**

Kies **Set Up 05**. Druk op  om het geheugen te resetten.

Reset memory?	
No	OK

Druk op  om het resetten van het geheugen te bevestigen

Druk op  om het menu te verlaten zonder het geheugen te resetten.

**Waarden naar de fabrieksinstellingen resetten.**

Kies **Set Up 06**.

Druk op  om het menu in te gaan; op het display verschijnt:

Default	
Nee	OK

Druk op  om de default parameters opnieuw op te roepen.

Druk op  om het menu te verlaten.







## Instellen van tijd en datum

De tijd en datum worden in de sturing als volgt ingesteld:

Kies **Menu 06** en druk op  om in het menu te komen.

Op het display verschijnt:





Date: 10/06/05  
Hour: 14:22:46

Verander het knipperende cijfer met behulp van de pijltjestoetsen  . Druk op  om op te slaan en naar het volgende cijfer door te gaan. Druk op  om terug naar het hoofdmenu te gaan.

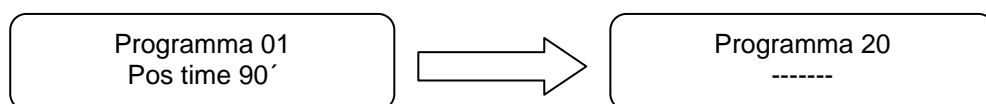
## De programma's opslaan

Kies **Menu 07** en druk op  om in het menu te komen. Het display toont het programmanummer en of er iets opgeslagen is:



Gebruik de pijltjestoetsen   om de programma's van 01 tot 20 door te lopen. Druk op de  toets om het programma op te slaan. Druk om het programma te verlaten op .

## Alarmen

De sturing slaat de alarmen op die in het geheugen staan, en het is mogelijk om ze te zien door in dit menupunt te gaan. Het is mogelijk tot 30 alarmen in het geheugen te bewaren.

Kies **Menu 08** en druk op  om in het menu te komen.

Als er geen alarmen zijn opgeslagen, toont het display:



No date

Het display toont de alarmen in de volgorde van A01 tot A30. Tevens wordt het tijdstip voor alarmstart en datum getoond:

A05 Err room  
S 14:21 10/06/05

Door op  te drukken verschijnt informatie over het type alarm: max. of min. temperatuur, duur, haal de service erbij, tijdstip voor deactiveren, of dat het alarm nog steeds actief is:

A05 Err room  
Present

Men kan met de pijltjestoetsen door de alarmmenu's lopen  .

Druk op  om terug naar het hoofdmenu te gaan.

## Gegevens uitdraaien

**Nota:** het extra materiaal is nodig voor deze functie.

Kies **Menu 09** en druk op  om in het menu te komen.

Op het display verschijnt:

data printen?  
Nee Ok



Druk op  om gegevens uit te draaien.

Druk op  om het menu te verlaten zonder uit te draaien.

## Ingangen/uitgangen

In dit menu worden de actuele waarden voor ingangen en uitgangen getoond, bv. de actuele temperaturen op de voelers of de status van de relais.

Kies **Menu 10** en druk op  om in het menu te komen.

Men kan met de pijltjestoetsen door de verschillende gegevens lopen  .

Room -6°C  
Needle 15°C

Ruimte- en kerntemperatuur.

Evapor. -10°C  
Conden. 21°C

Verdamper- en condensortemperatuur.



C D FE FC L R A  
1 0 0 1 1 0 0

Outputs:  
1= relais geactiveerd  
0= relais gedeactiveerd

DI1 DI2 FAN  
0 1 80

Digitale inputs en snelheid verdamperventilator.

## Ventilatorsnelheid

De ventilatoren zijn normaal op 100% snelheid ingesteld. Maar de snelheid kan tot 50% verlaagd worden. Door op  te drukken terwijl het proces aan de gang is, kan men de actuele snelheid zien. De snelheid is te wijzigen door op  te drukken.

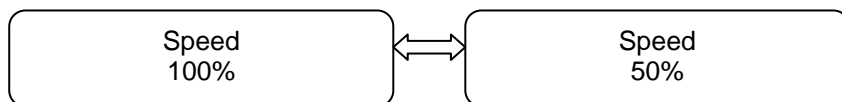

Druk op  om het programma te verlaten.

## Reinigen



**Haal de stekker uit het contact voordat u de kast gaat reinigen.**

De compressorruimte en het koelelement mogen niet met water gespoeld worden, aangezien de elektrische delen kunnen kortsluiten, beschadigen e.d.

Het meubel moet met een zacht sopje met passende tussenpozen van binnen en van buiten gereinigd en grondig gecontroleerd worden voordat het weer in bedrijf gesteld wordt.

De buitenkant kan met spray voor roestvast staal onderhouden worden.



Reinigingsmiddelen die chloor of chloorverbindingen bevatten, evenals andere agressieve middelen, **mogen niet gebruikt worden** aangezien ze corrosie kunnen veroorzaken op de roestvrije vlakken en het inwendige koelsysteem.

De compressorruimte, en met name de condensor, vrij van stof en vuil houden. Dit doet u het beste met een stofzuiger en een stijve borstel.

Noteer een evt. reiniging van de condensator in het reinigingsschema.

## Dooiwater

Het ontdooiwater gaat via een leiding in de achterwandisolatie naar beneden. Onderaan deze afvoerleiding moet een waterslot worden gevormd voordat aan verdere waterafvoer kan worden aangesloten.

**NB:** Het is belangrijk dat het waterslot schoon gehouden wordt omdat het dooiwater anders terug in de kast kan lopen.

## Onderhoud

Het koeltsysteem en de hermetisch gesloten motor-compressor vragen geen onderhoud. Schoonhouden is voldoende. Het frontpaneel kan worden verwijderd door het omhoog te schuiven. Indien de kast niet koelt is het eerst zinvol de elektrische aansluiting, stekker en zekeringen te controleren. Wanneer bij storing de oorzaak niet gevonden kan worden, waarschuw uw leverancier onder vermelding van het typenummer, ser.no. en part no. TYPE, SER.NO. en PART NO. zijn te vinden op het typeplaatje.

Plaatsing van het typeplaatje:

### KPS 90

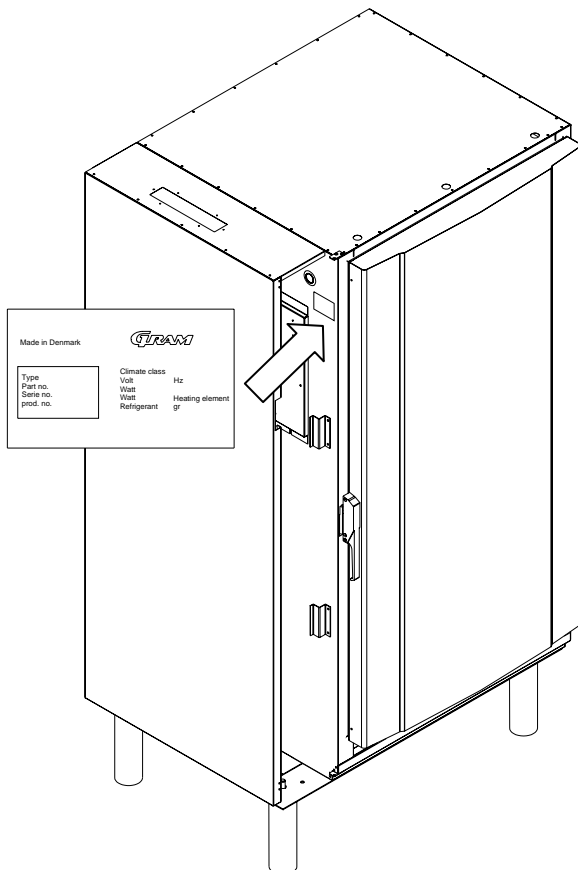

### KPS 60

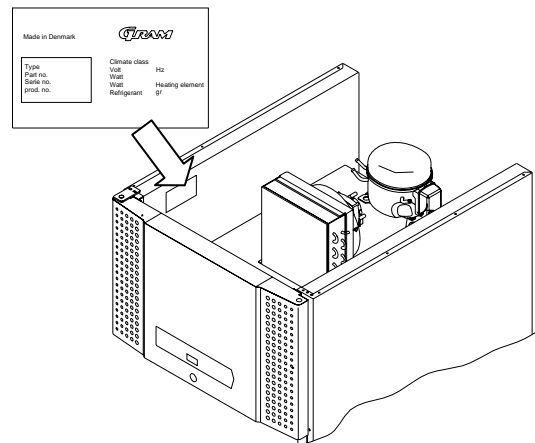

## Verschroten

Als de afgedankte kast moet worden verschromen, zal dit op een voor het milieu correcte en verantwoorde wijze gedaan moeten worden. Neem de milieubepalingen betreffende verschromen in acht. Het kan zijn dat er speciale eisen/voorwaarden zijn die moeten worden nageleefd.

# SVENSKA

## Uppställning

Skåpet bör placeras i ett torrt och tillräckligt ventilerat rum. För att säkra effektiv drift måste placeringen i direkt solljus eller nära varma ytor undvikas. Skåpet har konstruerats så, att det kan arbeta vid en omgivningstemperatur av upp till + 40°C. I modellerna med ben rättas skåpet upp, så att det står helt vågrätt med hjälp av ställskruvar under skåpet.

## Garanti och varning

Garantin gäller med förutsättning att nedanstående krav efterföljes:

- 1) Kylsystemet får endast repareras av en auktoriserad kylfirma.
- 2) Syrahaltiga matvaror måste vara övertäckta under förvaring i skåpet.
- 3) De elektriska och elektroniska delarna får endast servas/bytas ut av auktoriserad personal.

### Varning:

Ert kyl- eller frysskåp är avsett för förvaring av matvaror och liknande. Skåpet får inte användas till förvaring av varor som avger explosionsfarliga ångor, då risk för explosion kan uppstå.

På ställen där varningstrianglar används och/eller där skruvar säkrar avskärmningar (t.ex de elektriska delarna, värmeslingor och rörliga delar såsom fläktar) får endast öppnas när strömmen är bruten vid stickkontakten. Ingrepp får endast göras av auktoriserad personal. Strömbrytaren på panelskärmen bryter inte strömmen till alla komponenter i skåpet, vilket gör att det är livsfarligt att lossa de elektriska delarna utan att bryta strömmen vid stickkontakten. För att fukt inte skall tränga in i skåpets elektriska delar undvik att spruta vatten direkt på skåpets panelskärm eller kylsystem vid rengöring.

## Elanslutning

Skåpet ansluts till 230 V 50 Hz. Anslutningsvärdena finns angivna på typnummerskylden.

## Beskrivning av kontrollpanelen

Innan enheten tas i bruk ska nedanstående beskrivning av den elektroniska kontrollpanelens styrfunktioner noggrant läsas igenom

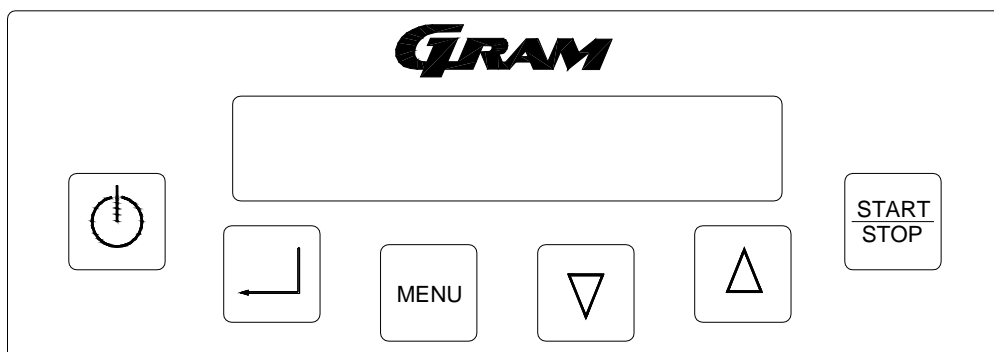

### Knappsats:



#### **On/off**

Genom att trycka på  i 5 sekunder slocknar styrningen och displayen visar **OFF**. Genom att trycka på knappen igen startar styrningen i stand-by läge.



Vid service:

Om service utförs på de elektriska komponenterna ska frångkoppling göras vid stickkontakten. Det räcker **inte** att koppla ifrån enheten med ON/OFF-knappen eftersom det fortfarande finns spänning till enskilda elektriska komponenter på enheten.





#### **Enter**

Ger åtkomst till menyn eller val av parametrar.



#### **Meny**

Ger åtkomst till huvudmenyn eller retur till föregående meny. För att få åtkomst till de olika menyerna: tryck på knappen och välj den önskade menyn med hjälp av pilknapparna  .

<p>Menu 01 Inställningar</p>	<p>Inställningar för fläktkyl.</p>
<p>Menu 02 Lager</p>	<p>Inställningar för lager.</p>
<p>Menu 03 Programm</p>	<p>Val av program.</p>
<p>Menu 04 Avfrostning</p>	<p>Start av avfrostning</p>
<p>Menu 05 Inställning</p>	<p>Programinställningar.</p>
<p>Menu 06 Ur inställning</p>	<p>Inställning av klocka.</p>
<p>Menu 07 Minne</p>	<p>Lagring av program.</p>
<p>Menu 08 Alarm</p>	<p>Larminställningar.</p>
<p>Menu 09 Utskrift</p>	<p>Utskrift av data.</p>
<p>Menu 10 Ingång/utgång</p>	<p>tgångar</p>
<p>Menu 11 Sterilisering</p>	<p>gsprocess.</p>

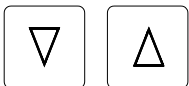

### Pilknapparna upp/ned.

Används för att bläddra i menyer eller för att ändra värden.







### Start/stopp.

Start / stopp av process.

## Igångsättning

Anslut enheten till elnätet.



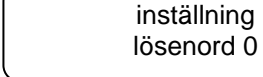

Tryck på  knappen.

Tryck därefter på  knappen och välj önskad meny med hjälp av pilknapparna  .

## Val av språk





Välj **Meny 05** och tryck på  för att komma in i menyn. Displayen visar: 

Default lösenord: **-19**

Välj ett lösenord med hjälp av pilknapparna   och tryck på . Tryck nu på  för att komma in i huvudmenyn för att programmera:

Välj **Set Up 04**. Tryck därefter på , härfter visas den första språkinställningen i displayen.

språk  
svenska



Använd pilknapparna   till att bläddra fram till önskat språk. Tryck på  för att bekräfta valet av vederbörande språk eller tryck på  för att återvända utan att ändra språkinställningarna.





## Flätkylning

Välj **Meny 01** för att ställa in och starta en nedkylningsprocess. Tryck på  för att få åtkomst till att ställa in nedkylningsprocessen

Val av flätkyl/fläktfrys:

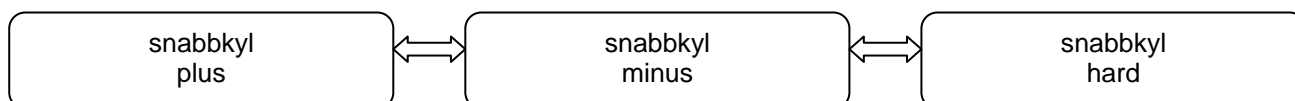
Tryck nu på  för att ändra inställningarna, som nu blinkar i displayen, med hjälp av pilknapparna  .



Tryck på  för att välja önskad inställning

Val av tidsstyrd eller temperaturstyrd nedkylning:

Använd därefter pilknapparna   till att ställa in om man ska köra efter tid eller kärntemperatur:

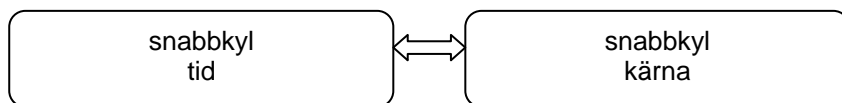

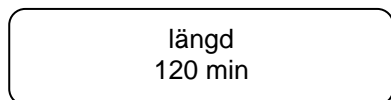

Väljs tidsstyrd nedkylning kan tiden ställas så här:

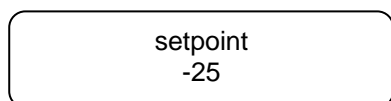

Väljs kärntemperaturstyrd nedkylning kan temperaturen ställas in så här:



Tryck på  för att starta vald process eller tryck på  för att lämna programmet utan att starta processen.

OBS: Under nedkylningsprocessen är det möjligt att gå in i **Meny 01** för att titta på inställningarna men de kan inte ändras så länge processen är i drift.

Nedkylnings- och infrysningshastigheten beror på följande faktorer:



- Livsmedlets tjocklek och förvaringsformarnas form, typ och material
- Mängden livsmedel och sammansättning
- Behållare med eller utan lock
- Livsmedlets temperatur vid början av nedkylningen / infrysningen
- Livsmedlets värmeledningsförmåga

Tiden för snabb nedkylning / infrysning är dessutom beroende av den behandlade typen av livsmedel. Med hänsyn till nedkylningstiden bör innehållet per 1/1 GN-behållare inte överstiga 3,5 kg eller en tjocklek på 50 mm. Vid behandling av besvärliga och/eller stora varor bör tjockleken reduceras ytterligare.



Placera livsmedlet i fläktkylen så att det fördelas jämnt över hela skåpets invändiga höjd. 1/1 GN-behållare placeras så nära fläktsektionen som möjligt och med ett inbördes avstånd som möjliggör en lämplig luftcirkulation (ca. 25 mm).

## Lagerprogram

Välj **Meny 02** och tryck på  för att komma in i menyn.

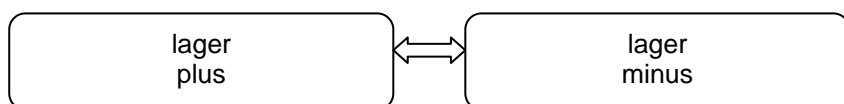
Tryck på  för att ändra inställningarna. Använd pilknapparna   för att välja kyl eller frys:



Tryck på  för att välja önskat program. Använd pilknapparna   för att ändra inställningspunkten:

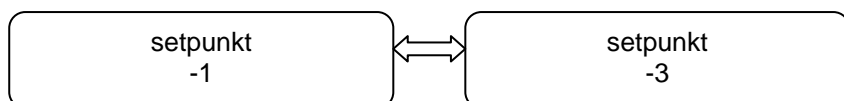

Tryck på  för att starta valt program eller tryck på  för att gå ur programmet.



## Användning av program

Det er möjligt att använda användarprogram som man själv lagrat, eller att välja mellan en rad förprogrammerade program.

### Användarprogram:

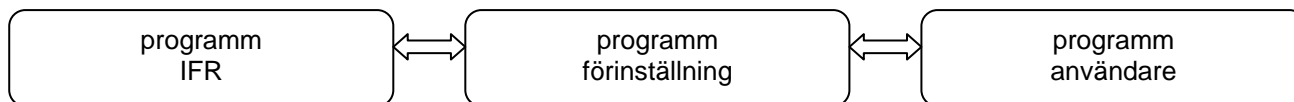

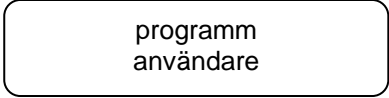

Välj **Meny 03** och tryck på  för att komma in i menyn:

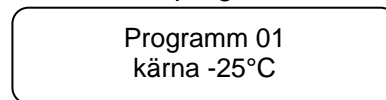

Välj  och tryck på  för att komma in i användarprogrammet (01-20).



Displayen visar programnumret och vilken typ av process som lagrats:





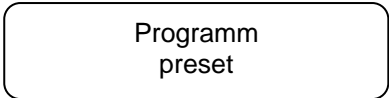

Använd pilknapparna   för val av program. Tryck på  för att starta valt program eller tryck på  för att gå ut ur programmet och starta processen.

Genom att trycka på  väljs aktuellt program och enheten går in i stand-by läge.

### Förprogrammerade program:

Välj  och tryck på  för att komma in i de förprogrammerade programmen 21-29.

Finn önskat program med hjälp av   . Tryck på  för att starta valt program eller tryck på  för att lämna programmet.

Det finns följande program att välja mellan:

Prog	Namn	Positiv/negativ	Tid/temperatur	Hard	Rumtemp. setpunkt lager	Tid
21	kött	positiv	temperatur	ja	+2°C	120 min.
22	mejeriprd	positiv	tid	nej	+2°C	90 min.
23	tärtor	positiv	tid	nej	+2°C	90 min.
24	sammankokt	positiv	tid	nej	+2°C	90 min.
25	fisk	positiv	tid	ja	+2°C	90 min.
26	kyckling	positiv	tid	ja	+2°C	90 min.
27	grönsaker	positiv	tid	nej	+2°C	90 min.
28	frys temperatur	negativ	temperatur	ja	-22°C	240 min.
29	frys tid	negativ	tid	ja	-22°C	240 min.

## Avfrostning

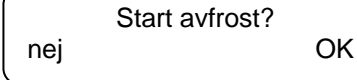
Välj **Meny 04** och tryck på  för att komma in i menyn. Displayen visar: 

Avfrostningen startas genom att trycka på . För att deaktivera avfrostningen tryck på .



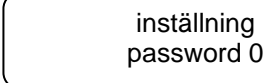

Tryck på  för att gå tillbaka till menyn utan att starta avfrostningen.

**OBS:** Avfrostningen kan aktiveras direkt från huvudmenyn genom att trycka  in i 5 sekunder.





## Inställningar

Välj **Meny 05** och tryck på  för att komma in i menyn. Displayen visar: 

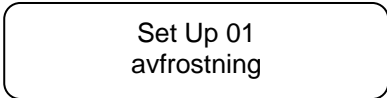
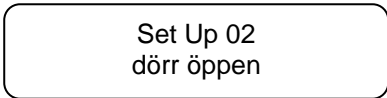
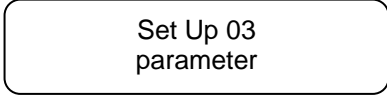
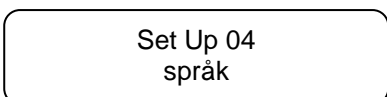
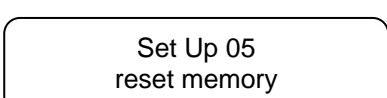
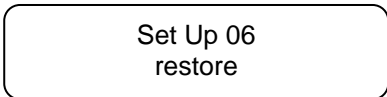
Default lösenord: **-19**

Välj ett lösenord med hjälp av pilknapparna   och tryck på . Tryck nu på  för att komma in i huvudmenyn för att programmera:

	Visar de senaste avfrostningarna.
	Visar de senaste dörröppningarna.
	Ändring av parameter.
	Val av språk.
	Återställning av minnet.
	Återställning av värden till fabriksinställning.

Använd pilknapparna   för att välja undermenyer. Välj önskad undermeny med . Tryck på  för att återvända till huvudmenyn.

### Visning av de senaste avfrostningarna:

Välj **Set Up 01**. Tryck därefter på  för att se de senaste 32 avfrostningsprocesserna och tillhörande data. Displayen visar starttid och data, tidsåtgång för avfrostningen i minuter, samt ordningsföljden från D01 till D32.

D09      22Min      M=03  
S 11:44 10/06/05

M indikerar hur avfrostningen sattes igång:

M=01 Avfrostningen startades manuellt under lagerkylning.

M=02 Periodisk avfrostning under lagerkylning.

M=03 Avfrostning startades vid start av nedkylningsprocess.

Det är möjligt att bläddra i avfrostningarna med hjälp av  .

Om ingen avfrostning sparats visar displayen **Ingen data** .



Tryck på  för att återvända till huvudmenyn.

### Visning av dörröppningar:

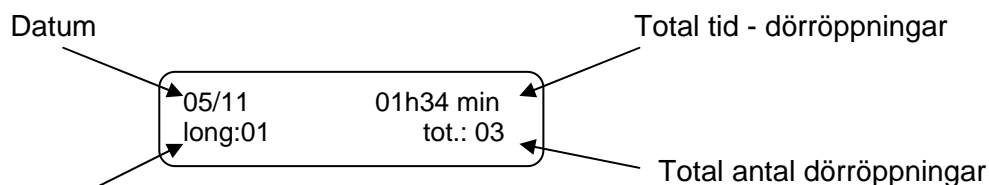
Välj **Set Up 02**. Tryck därefter på  för att se de senaste dörröppningarna. Styrningen memorerar dörröppandet i upp till 31 dagar.



Antal dörröppningar, som  
överskrider  
tidsinställningen för  
dörrlarm

Använd pilknapparna   för att välja övriga datum för dörröppning.

Tryck på  för att återvända till huvudmenyn.



### Ändring av parameter:



Välj **Set Up 03**. Tryck därefter på  för att få åtkomst till inställning av parameter.

Parameter namn  
och värde

Beskrivning

A01 = -5°C  
Llågt larm

Använd pilknapparna   till att bläddra i de olika parametrarna.

För att ändra en parameter tryck på  och använd därefter pilknapparna   till att ändra värdena.

Tryck igen på  för att bekräfta det nya värdet. Tryck på  för att återvända till menyn.

### Översikt över parameter:

Parameter	Beskrivning	Fabr. inställning	Min.	Max.
<b>Fläktkyl, plus</b>				
P01	Rumstemperatur inställningspunkt, mjuk	-5°C	-30°C	30°C
P02	Rumstemperatur inställningspunkt, hård	-25°C	-40°C	30°C
P03	Spjuttemperatur inställningspunkt, mjuk	3°C	-30°C	30°C
P04	spjuttemperatur inställningspunkt, hård	20°C	-30°C	30°C
P05	Tidsåtgång av process	90 min	0 min	900 min
P06	Hård faslängd i % relativ till P05	60%	0%	100%
P07	Rumstemperatur inställningspunkt, lager	2°C	-30°C	30°C
<b>Fläktkyl, minus</b>				
N01	Rumstemperatur inställningspunkt	-25°C	-40°C	30°C
N02	Spjuttemperatur inställningspunkt	-18°C	-30°C	30°C
N03	Tidsåtgång av process	240 min	0 min	900 min
N04	Rumstemperatur inställningspunkt, lager	-22°C	-40°C	30°C
<b>Larm</b>				
A01	Temperaturlarm hysteres	2°C	0°C	10°C
A02	Övre temperaturlarm, relativ till P07	10°C	0°C	50°C
A03	Nedre temperaturlarm, relativ till P07	-10°C	-50°C	0°C
A04	Övre temperaturlarm, relativ till N04	10°C	0°C	50°C
A05	Nedre temperaturlarm, relativ till N04	-10°C	-50°C	0°C
A06	Temperaturlarm försening från lager och avfrostningsstart	60 min	0 min	300 min
A07	Temp.larm försening	30 min	0 min	300 min

För inställning av övriga parametrar hänvisas man till Betjänings- och servicemanualen. Denna kan, om nödvändigt, beställas hos Din försäljare.

### Återställning av minnet:

Välj **Set Up 05**. Tryck på  för att nollställa minnet.

Reset memory?  
No OK

Tryck på  för att bekräfta nollställning av minnet.

Tryck på  för att lämna menyn utan att nollställa minnet.

### Återställning av värden till fabriksinställningarna:

Välj **Set Up 06**. Tryck på  för att gå in i menyn, displayen visar:

Default  
No OK

Tryck på  för att återskapa grundinställningsparametrarna.





Tryck på  för att lämna menyn.

## Inställning av tid och datum

Tid och datum i styrningen ställs in på följande sätt:

Date: 10/06/05  
Hour: 14:22:46





Välj **Meny 06** och tryck på  för att komma in i menyn. Displayen visar:

De blinkande siffrorna ändras genom att använda pilknapparna  . Tryck på  för att lagra och gå vidare till nästa siffra. Tryck på  för att återvända till huvudmenyn.

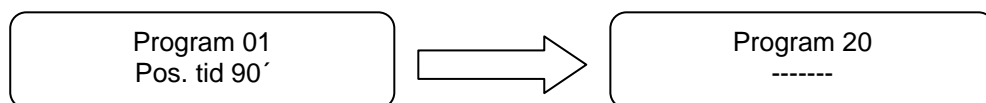
## Lagring av program

Välj **Meny 07** och tryck på  för att komma in i menyn. Displayen visar programnumret och visar dessutom om det är lagrat eller ej:



Använd pilknapparna   till att se genom program från 01 till 20. För att lagra ett program, tryck på  knappen. För att lämna programmet utan att lagra, tryck på .

## Larm

Styrningen lagrar de larm som varit i minnet och det är möjligt att se dem genom att gå in i denna meny punkt. De kan lagras upp till 30 larm i minnet.

Välj **Meny 08** och tryck på  för att komma in i menyn.

När det inte är lagrat något larm, visar displayen:



Ingen data

Displayen visar larmen i ordningsfölj från A01 till A30. Dessutom visas tidpunkten för larm, start och datum:

A05 Err. room  
S 14:21 10/06/05

Genom att trycka på  kan man få övriga upplysningar om typen av larm: max eller min temperatur, tidsåtgång, ring efter service, tidpunkt för de-aktivering eller om larmet är stabilt eller konstant aktivt.

A05 Err. room  
Present

Man kan bläddra i larmmenyn med pilknapparna  .

Tryck på  för att återvända till huvudmenyn.

## Utskrift av data

**OBS:** ekstra utstyr er nødvendig for denna funktionen.

Välj **Meny 09** och tryck på  för att komma in i menyn. Displayen visar:

Skriv ut data?  
No Ok



Tryck på  för att skriva ut data.

Tryck på  för att lämna menyn utan att skriva ut.

## Ingångar/utgångar

I denna meny visas de aktuella värdena för ingångar och utgångar, t.ex. de aktuella temperaturer på sensorer och status för reläer.

Välj **Meny 10** och tryck på  för att komma in i menyn.

Man kan bläddra i de olika data med pilknapparna.  .

Room -6°C  
Needle 15°C

Rum- och spjuttemperatur.

Evapor. -10°C  
Conden. 21°C

Kylelement- och kondensortemperatur.



C D FE FC L R A  
1 0 0 1 1 0 0

Outputs:  
1= relä aktiverat  
0= relä de-aktiverat

DI1 DI2 FAN  
0 1 80

Digitala ingångar och hastigheten för kylelementsfläkten.

## Fläkthastighet

Fläktarna är normalt inställda på att köra med 100% hastighet. Det är dock möjligt att reducera hastigheten till 50%. Genom att trycka på  medan processen är igång kan man se den aktuella hastigheten. Hastigheten kan ändras genom att trycka på .

Hastighet  
100%



Hastighet  
50%

Tryck på  för att lämna programmet.



## Rengöring



**För rengöring ska enheten stängas av på stickkontakten.**

Man får inte spola med vatten i kompressorummet och genom kylelementet, eftersom det kan uppstå kortslutningar och liknande på elektriska komponenter.

Med jämna mellanrum ska enheten rengöras invändigt och utvändigt med en svag tvållösning och kontrolleras grundligt innan enheten sätts igång igen.

Enhetens utvändiga yta kan underhållas med vårdande spray för rostfritt stål.



Rengöringsmedel som innehåller klor eller klorföreningar, samt andra aggressiva medel **bör inte användas** eftersom de kan förorsaka skador på de rostfria ytorna och det invändiga kylsystemet.

Kompressorummet och särskilt kondensorn ska hållas fri från damm och smuts, vilket görs bäst med en dammsugare eller en hård borste.

Notera ev. rengöring av kondensorn på rengöringsschemat.

## Tövatten

Tövatten leds genom ett rör i isoleringen. Röret leder ut på skåpets baksida. Det skall monteras ett vattenlås innan tövattnet kopplas till avloppet.

**OBS:** Det är viktigt att hålla vattenlåset rent eftersom tövattnet kan rinna tillbaka in i enheten.

## Service

Kylsystemet och den hermetiskt låsta kompressorn kräver ingen större tillsyn - endast renhållning. Fronten ovanför panelskärmen kan avlägsnas genom ett lätt ryck. Sviktar kylverkan måste ni först undersöka om orsaken är avbrott vid stickkontakten eller avbrott i säkringsgruppen. Om orsaken till kylverkan inte hittas, hänvisas till leverantören. Vid kontakt med leverantören skall skåpets typ, serie - och partnummer anges. Dessa uppgifter finns på typnummerskylten.

## Placering av typnummerskylten:

### KPS 90

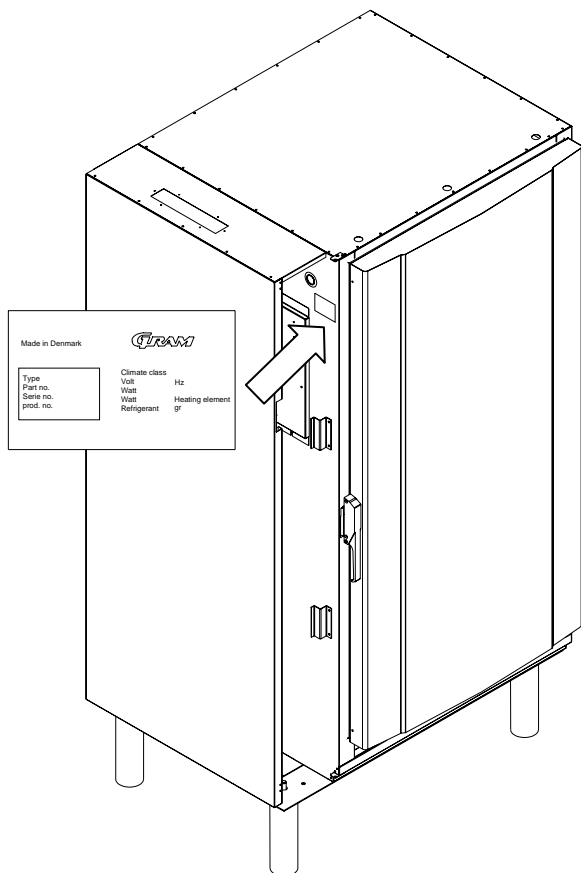

### KPS 60

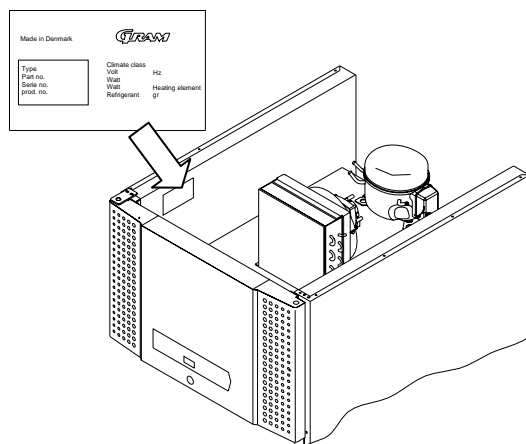

## Bortskaffning

När uttjänta produkter ska bortskaffas ska detta ske på ett miljömässigt korrekt sätt. Var uppmärksam på regler för bortskaffning. Det kan finnas speciella krav/regler som ska uppfyllas.

# FRANÇAIS

## Installation

Placer l'appareil dans un local sec et suffisamment ventilé. Pour un fonctionnement efficace, éviter la lumière directe et la proximité des sources de chaleur. L'appareil est conçu pour pouvoir fonctionner dans une température ambiante pouvant aller jusqu'à +43°C. S'il s'agit du modèle à pieds, placer celui-ci bien droit en jouant sur les vis de réglage des pieds.

## Garantie et avertissement

La validité de la garantie est subordonnée aux conditions minimum suivantes:

1. Le système de refroidissement ne doit être réparé que par une entreprise frigorifique autorisée.
2. Les aliments à teneur acide doivent être couverts pendant leur stockage dans la cuve, pour empêcher la corrosion des parties internes de l'appareil.
3. Les pièces électriques et électroniques ne doivent être contrôlées/changées que par un personnel agréé.

### **Avertissement:**

Votre réfrigérateur ou congélateur est spécialement conçu pour le stockage des denrées alimentaires et produits similaires. L'appareil ne doit pas servir à stocker des marchandises qui libèrent des vapeurs explosives pouvant entraîner des risques d'explosion. Les endroits portant des triangles d'avertissement et /ou des vis fixant des écrans protecteurs (par ex. en ce qui concerne les pièces électriques, les pièces de chauffe et les pièces mobiles comme les ventilateurs) ne doivent être ouverts que lorsque le courant a été coupé au niveau de la prise. Seul un personnel agréé peut intervenir.

L'interrupteur placé sur le bandeau de visualisation ne coupe pas le courant pour toutes les composantes de l'appareil. C'est pourquoi on court un danger mortel si l'on ne coupe le courant qu'au niveau du bandeau lorsqu'on découvre les parties électriques. Par conséquent, il faut également couper le contact en retirant le fil électrique de la prise. Pour s'assurer qu'il ne pénètre pas d'eau dans les parties électriques de l'appareil, ne pas projeter de l'eau directement sur le bandeau de visualisation et sur le système de refroidissement.

## Branchement électrique

L'appareil est conçu pour un branchement sur courant alternatif. Les valeurs de branchement pour la tension (V) et la fréquence (Hz) sont indiquées sur la plaque d'identification du type.

## Description du panneau de contrôle

Avant d'utiliser l'appareil, veuillez lire attentivement la description ci-dessous concernant les fonctions de commande électronique du panneau de contrôle.

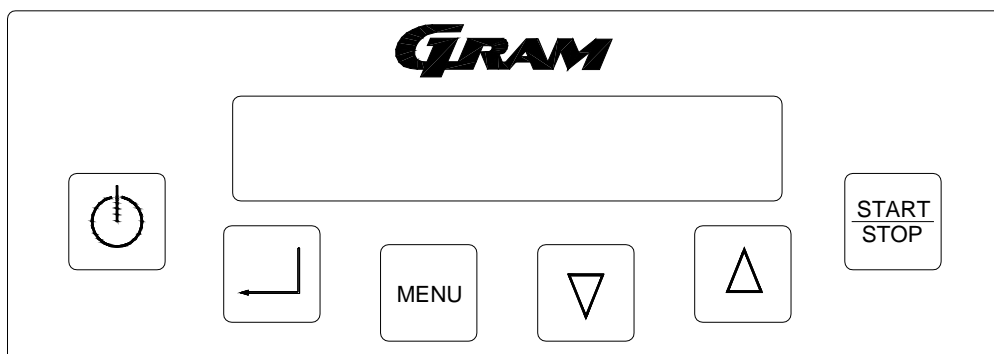

### Touches:



#### **On/off**

En appuyant sur  pendant 5 secondes, la commande s'éteint et l'écran affiche **OFF**. En appuyant de nouveau sur la touche, la commande est mise en état de veille.



En cas d'opération de maintenance:

sur les parties électriques, couper le courant au niveau de la prise. Il ne suffit **pas** d'éteindre l'appareil au niveau de la touche ON/OFF, car il y aurait toujours de la tension dans certains éléments électriques de l'appareil.





#### **Enter**

Donne accès au menu ou au choix des paramètres.



## Menu

Donne accès au menu principal ou permet de retourner au menu précédent. Pour accéder aux différents menus, appuyez sur la touche et choisissez le menu désiré à l'aide des flèches.  .

Menu 01  
Set

Réglages de la réfrigération à froid ventilé

Menu 02  
Conservation

Réglages pour le stockage

Menu 03  
Programmes

Choix des programmes

Menu 04  
Dégivrage

Lancement du processus de dégivrage

Menu 05  
Positions

Réglages des programmes

Menu 06  
Regler Horloge

Réglage de l'horloge.

Menu 07  
Memorisation

Mémorisation des programmes.

Menu 08  
Alarme

Réglages de l'alarme.

Menu 09  
Imprimer

Impression des données

Menu 10  
Entrees/Sorties

Statut des entrées et des sorties.

Menu 11  
Stérilisation

Activation du processus de stérilisation.



**Flèches haut/bas.**

S'utilisent pour parcourir les menus ou modifier des valeurs.





**Marche/arrêt.**

Lancement/ interruption du processus.

## Mise en marche

Brancher l'appareil correctement sur le réseau électrique.

Appuyez sur la touche 

Appuyez ensuite sur la touche  puis choisissez le menu désiré à l'aide des flèches  .

## Choix de la langue

Choisissez **Menu 05**, et appuyez sur  pour entrer dans le menu.

L'écran affiche :

Positions  
password 0





Mot de passe défaut: **-19**

Choisissez le mot de passe à l'aide des touches fléchées  , puis appuyez sur .

Appuyez maintenant sur  pour accéder au menu principal de la programmation :

Choisissez **Positions 04**. Appuyez ensuite sur , le premier réglage de langue est alors affiché à l'écran.



langue  
français

Utilisez les flèches   pour naviguer jusqu'à la langue désirée. Appuyez sur  pour confirmer le choix de la langue ou appuyez sur  pour revenir en arrière sans modifier le réglage de la langue.

## Réfrigération à froid ventilé

Choisissez **Menu 01** pour programmer et lancer un processus de réfrigération. Appuyez sur  pour accéder au réglage du processus de réfrigération.



### Choix de la réfrigération/congélation à froid ventilé

Appuyez maintenant sur  pour modifier les paramètres qui clignotent à l'écran à l'aide des flèches   :

refroidis rapide positif ↔ refroidis rapide négatif ↔ refroidis rapide hard

Appuyez sur  pour sélectionner le réglage désiré.

### Choix d'une réfrigération avec contrôle du temps ou de la température.

Utilisez ensuite les flèches   pour décider si le fonctionnement doit se faire selon le temps ou la température.



refroidis rapide temps ↔ refroidis rapide coeur

Si vous choisissez la réfrigération avec contrôle du temps, il est possible de régler la durée :

duree  
120 min

Si vous choisissez une réfrigération selon une température de base, il est possible de régler la température.

set point  
-25

Appuyez sur  pour lancer le processus choisi ou appuyez sur  pour quitter le programme sans lancer le processus.

N.B.: Pendant le processus de réfrigération, il est possible d'entrer dans le **Menu 01** pour voir les paramètres des réglages choisis mais il n'est pas possible de les modifier tant que le processus est en cours de fonctionnement.

La vitesse de réfrigération et de congélation dépend des facteurs suivants:



- L'épaisseur des aliments ainsi que la forme, le type et la matière des récipients
- La quantité d'aliments et leur composition
- La présence ou l'absence de couvercle sur les récipients
- La température des aliments au début de la réfrigération /congélation
- La conductibilité thermique des aliments

Le temps de réfrigération / congélation rapide dépend en outre du type d'aliments préparés. Pour assurer un temps de réfrigération correct, le contenu de chaque récipient GN 1/1 ne doit pas dépasser 3,5 kg ou une couche à l'épaisseur maximale de 50 mm. Le traitement de produits plus difficiles et/ou plus conséquents exige des couches encore plus minces.



Placer les aliments dans le réfrigérateur à froid ventilé en les répartissant uniformément sur toute la hauteur à l'intérieur de l'appareil. Placer les récipients GN 1/1 aussi près que possible de la section soufflante et les séparer les uns des autres par un espace permettant à l'air de circuler correctement (env. 25 mm).

## Programme de stockage

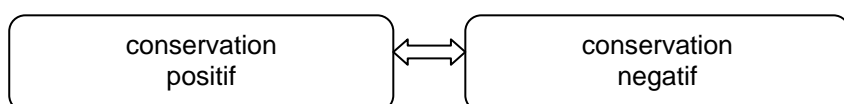

Choisissez **Menu 02**, et appuyez sur  pour entrer dans le menu.

Appuyez sur  pour modifier les paramètres de réglage. Utilisez les flèches   pour choisir réfrigération ou congélation :

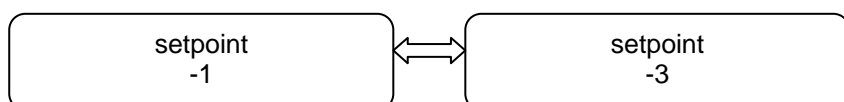

Appuyez sur  pour choisir le programme désiré. Utilisez les flèches   pour modifier le point de consigne :



Appuyez sur  pour démarrer le programme choisi ou appuyez sur  pour quitter le programme.





## Utilisation des programmes

Il est possible d'utiliser des programmes utilisateur, que l'on a soi-même enregistré, ou de choisir entre une série de programmes préréglés.

### Programmes utilisateur :

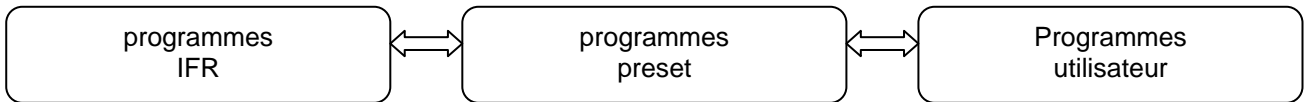

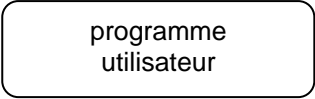

Choisissez **Menu 03**, et appuyez sur  pour entrer dans le menu.

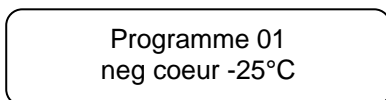

Choisissez  et appuyez sur  pour entrer dans les programmes utilisateurs (01-20).

L'écran affiche le numéro du programme et le type de processus chargé :







Utilisez les flèches   pour choisir les programmes. Appuyez sur  pour lancer le processus choisi ou appuyez sur  pour quitter le programme sans lancer le processus.

En appuyant sur , le programme désiré est sélectionné et l'appareil se met en état de veille.

### Programmes préréglés

Choisissez  et appuyez sur  pour accéder aux programmes préréglés (21-29).

Choisissez le programme désiré à l'aide de  . Appuyez sur  pour démarrer le programme choisi ou appuyez sur  pour quitter le programme.

Vous pouvez choisir entre les programmes suivants:

Prog	Nom	Positif/negatif	Temps/température	Hard	Setpoint cellule conservation	Temps
21	viandes	positif	temperature	oui	+2°C	120 min.
22	cremes	positif	temps	non	+2°C	90 min.
23	ab pates	positif	temps	non	+2°C	90 min.
24	abb prepares	positif	temps	non	+2°C	90 min.
25	ab prod poisson	positif	temps	oui	+2°C	90 min.
26	ab prod avicoles	positif	temps	oui	+2°C	90 min.
27	legumes	positif	temps	non	+2°C	90 min.
28	cong temperature	negatif	temperature	oui	-22°C	240 min.
29	cong temps	negatif	temps	oui	-22°C	240 min.

## Dégivrage

Choisissez **Menu 04**, et appuyez sur  pour entrer dans le menu.

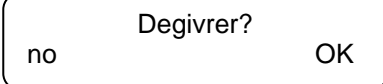
L'écran affiche : 

Le dégivrage est activé en appuyant sur . Pour désactiver le dégivrage, appuyez sur .

Appuyez sur  pour revenir en arrière dans le menu sans activer le dégivrage.



N.B.: Le dégivrage peut être activé directement à partir du menu principal en appuyant sur  pendant 5 secondes.

## Réglages

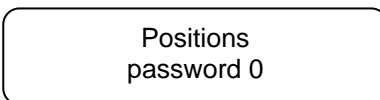
Choisissez **Menu 05**, et appuyez sur  pour entrer dans le menu.



L'écran affiche : 

Mot de passe défaut: **-19**

Choisissez le mot de passe à l'aide des touches fléchées  , puis appuyez sur .

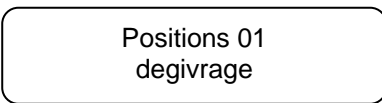
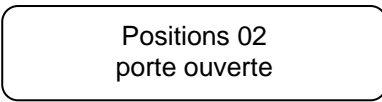
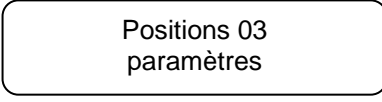
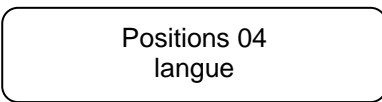
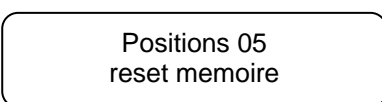
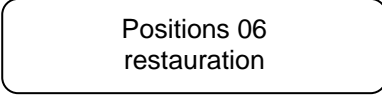
Appuyez maintenant sur  pour accéder au menu principal de la programmation :

	Affiche les derniers dégivrages.
	Affiche les dernières ouvertures de portes.
	Modification des paramètres.
	Choix de la langue
	Réinitialisation de la mémoire.
	Réinitialisation des valeurs du réglage d'usine.

Utilisez les flèches   pour choisir les rubriques. Choisissez la rubrique désirée avec .

Appuyez sur  pour retourner au menu principal.

Choisissez **Positions 01**. Appuyez ensuite sur  pour voir les 32 derniers processus de dégivrages et les informations correspondantes. L'écran affiche l'heure d'activation et la date, la durée du dégivrage en minutes ainsi que l'ordre de succession de D01 à D32.



D09      22Min      M=03  
S 11:44 10/06/05

M indique le mode de dégivrage activé :

M=01 Le dégivrage est activé manuellement pendant la réfrigération.

M=02 Dégivrage périodique pendant la réfrigération.

M=03 Dégivrage démarré au début du processus de réfrigération.

Il est possible de naviguer entre les dégivrages au moyen de  .



Si aucun dégivrage n'a été enregistré, l'écran affiche **No Date**.

Appuyez sur  pour retourner au menu principal.

### Affichage des ouvertures de porte :

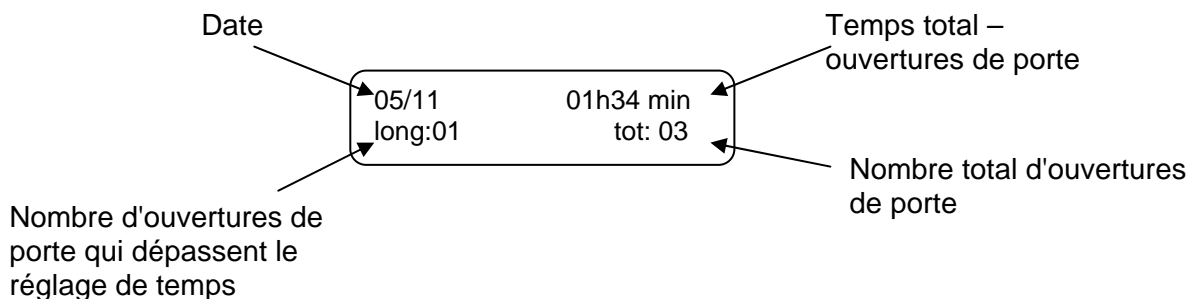
Choisissez **Positions 02**. Appuyez ensuite sur  pour voir les dernières ouvertures de porte. La commande se souvient des ouvertures de porte jusqu'à 31 jours.



Utilisez les flèches   pour choisir les autres dates d'ouverture de porte.

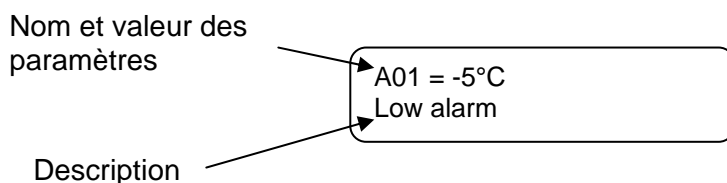

Appuyez sur  pour retourner au menu principal.

Choisissez **Positions 03**. Appuyez ensuite sur  pour accéder au réglage des paramètres.



Utilisez les flèches   pour naviguer entre les différents paramètres.

Pour modifier un paramètre, appuyez sur , puis utilisez ensuite les touches fléchées   pour changer la valeur.

Appuyez de nouveau sur  pour confirmer la nouvelle valeur. Appuyez sur  pour retourner au menu principal.

Liste des paramètres :

Paramètre	Description	Réglage d'usine	Min.	Max.
<b>Réfrigération rapide positive</b>				
P01	Setpoint cellule en réfrigération rapide positive, soft	-5°C	-30°C	30°C
P02	Setpoint cellule en réfrigération rapide, hard	-25°C	-40°C	30°C
P03	Setpoint pointeau en réfr. rapide positive et soft	3°C	-30°C	30°C
P04	Setpoint pointeau en réfrigération rapide, hard	20°C	-30°C	30°C
P05	Durée du processus	90 min	0 min	900 min
P06	La longueur de la phase hard en % par rapport à P05	60%	0%	100%
P07	Setpoint cellule en conservation positif	2°C	-30°C	30°C
<b>Réfrigération rapide negative</b>				
N01	Setpoint cellule de réfrigération rapide negative	-25°C	-40°C	30°C
N02	Setpoint pointeau en réfrigération rapide negative	-18°C	-30°C	30°C
N03	Durée du processus	240 min	0 min	900 min
N04	Setpoint cellule en conservation positive	-22°C	-40°C	30°C
<b>Alarmes</b>				
A01	Alarme de température hystérésis	2°C	0°C	10°C
A02	Température d'alarme supérieure, par rapport à P07	10°C	0°C	50°C
A03	Température d'alarme inférieure, par rapport à P07	-10 °C	-50°C	0°C
A04	Température d'alarme supérieure, par rapport à N04	10°C	0°C	50°C
A05	Température d'alarme inférieure, par rapport à N04	-10 °C	-50°C	0°C
A06	Retard de l'alarme de la température de stockage ou de démarrage du dégivrage	60 min	0 min	300 min
A07	Retard de l'alarme de température	30 min	0 min	300 min

Pour le réglage des autres paramètres se référer au Manuel d'utilisation et de maintenance. Celui-ci peut être, si nécessaire, fourni sur demande auprès de votre revendeur.

## Réinitialisation de la mémoire.

Choisissez **Positions 05.**

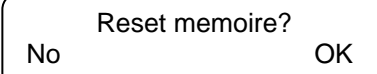
Appuyez sur  pour remettre à zéro la mémoire. 

Appuyez sur  pour confirmer la mise à zéro de la mémoire.

Appuyez sur  pour quitter le menu sans remettre à zéro la mémoire.

## Réinitialisation des valeurs du réglage d'usine.

Choisissez **Positions 06.**

Appuyez sur  pour accéder au menu affiché par l'écran : 

Appuyez sur  pour recréer les paramètres par défaut.





Appuyez sur  pour quitter le menu.

## **Réglage de l'heure et de la date**

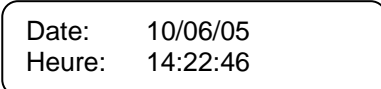
L'heure et la date de la commande sont réglées de la façon suivante :

Choisissez **Menu 06**, et appuyez sur  pour entrer dans le menu.





L'écran affiche : 

Les chiffres clignotants peuvent être modifiés en utilisant les flèches  . Appuyez sur  pour sauvegarder et continuer vers le chiffre suivant. Appuyez sur  pour retourner au menu principal.

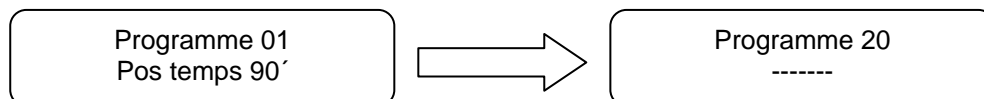
## **Mémorisation des programmes**

Choisissez **Menu 07**, et appuyez sur  pour entrer dans le menu. L'écran affiche le numéro du programme et indique de plus si celui-ci est mémorisé ou non :



Utilisez les flèches   pour parcourir les programmes de 01 à 20. Pour sauvegarder un programme, appuyez sur la touche . Pour sortir du programme sans sauvegarder, appuyez sur .

## Alarmes

La commande conserve les alarmes qui ont été mises en mémoire et il est possible de les visionner en entrant dans cette rubrique. Jusqu'à 30 alarmes peuvent être sauvegardées en mémoire.

Choisissez **Menu 08**, et appuyez sur  pour entrer dans le menu.

Si aucune alarme n'a été sauvegardée, l'écran affiche :

No date

L'écran affiche les alarmes dans l'ordre de A01 à A30. L'heure du démarrage de l'alarme et la date est de plus affichée :

A05 Err chambre  
S 14:21:00 10/06/05

En appuyant sur  des renseignements supplémentaires sur le type d'alarme sont fournis : température max ou min, la durée, le service d'appel, l'heure de désactivation ou bien si l'alarme est toujours active :

A05 Err chambre  
Present

On peut naviguer dans le menu de l'alarme avec les touches fléchées  .

Appuyez sur  pour retourner au menu principal.

## Impression des données

**Note** : l'équipement supplémentaire est nécessaire pour cette fonction.

Choisissez **Menu 09**, et appuyez sur  pour entrer dans le menu.

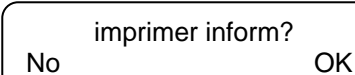
L'écran affiche :  imprimer inform?  
No OK

Appuyez sur  pour imprimer les données.

Appuyez sur  pour quitter le menu sans imprimer.

## Entrées/Sorties

Dans ce menu sont affichées les valeurs actuelles pour les entrées et les sorties, par ex. les températures actuelles des capteurs et le statut des relais.

Choisissez **Menu 10**, et appuyez sur  pour entrer dans le menu.

On peut naviguer entre les différentes données à l'aide des touches fléchées  .

Température ambiante et de pointe.

Evapor. -10°C  
Conden. 21°C

Température de l'évaporateur et du condensateur.



C D FE FC L R A  
1 0 0 1 1 0 0

Sorties :  
1 = Relais activé  
0 = relais désactivé

DI1 DI2 FAN  
0 1 80

Entrées numériques et vitesse de la soufflerie de l'évaporateur.

## Débit de soufflerie

Les ventilateurs sont normalement réglés pour fonctionner à 100% de leur vitesse. Il est cependant possible de réduire la vitesse jusqu'à 50%. En appuyant sur  tandis que le processus est actif, on peut voir la vitesse en cours. La vitesse peut être modifiée en appuyant sur .

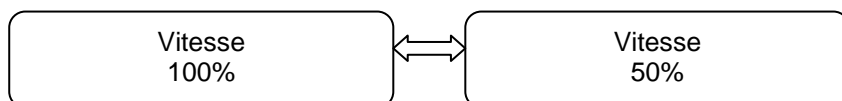

Appuyez sur  pour quitter le programme.

## Nettoyage



**Avant le nettoyage, l'appareil doit être arrêté au niveau de la prise secteur.**

Il ne faut pas laver à grande eau dans le compartiment des compresseurs et près de l'élément réfrigérant car cela pourrait causer des courts-circuits, des avaries etc. dans les parties électriques.

A intervalles réguliers, l'intérieur et l'extérieur du meuble doit être nettoyé avec une solution faiblement savonneuse puis contrôlé soigneusement avant que l'appareil ne soit de nouveau mis en fonction.

Les surfaces externes de l'appareil peuvent être entretenues avec un pulvérisateur de produit d'entretien pour acier inoxydable.



Les produits de nettoyage contenant du chlore ou des dérivés de chlore ainsi que d'autres produits agressifs **ne doivent pas être utilisés** car ils peuvent causer de la corrosion sur les surfaces inoxydables et sur le système intérieur de refroidissement.

Le compartiment des compresseurs et surtout le condensateur doit être exempt de poussière et de salissures, pour cela l'utilisation d'un aspirateur et d'une brosse dure est recommandée. Notez éventuellement le nettoyage du condensateur sur le planning de nettoyage.

## Eau de dégivrage

L'eau de dégivrage s'écoule par un tuyau placé dans l'isolation. Le tuyau sort à l'arrière de l'appareil. Il faut établir un siphon avant l'évacuation de l'eau de dégivrage dans les égouts.

**N.B. :** Il est important de garder le siphon propre car l'eau de dégel peut revenir dans l'armoire.

## Entretien

Le système de refroidissement et le compresseur hermétiquement fermé ne nécessitent aucune surveillance, simplement du nettoyage. Le panneau frontal recouvrant le bandeau de visualisation peut être enlevé par une poussée vers le haut.

Si l'effet de refroidissement fait défaut, s'assurer d'abord que la raison n'est pas un arrêt intempestif au niveau de la prise ou une interruption dans le groupe de fusibles.

Si la raison de l'arrêt du froid ne peut pas être trouvée, s'adresser au revendeur. Indiquez alors le nom du type de l'appareil ainsi que son numéro de lot et de série. TYPE, PART NO. et SER.NO se trouvent sur la plaque d'identification du type.

Emplacement de la plaque d'identification du type:

### KPS 90

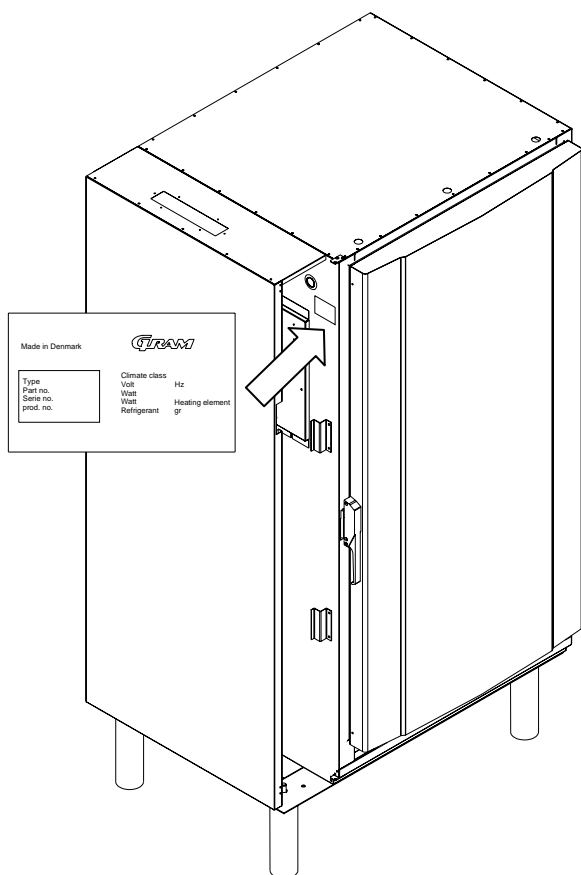

### KPS 60

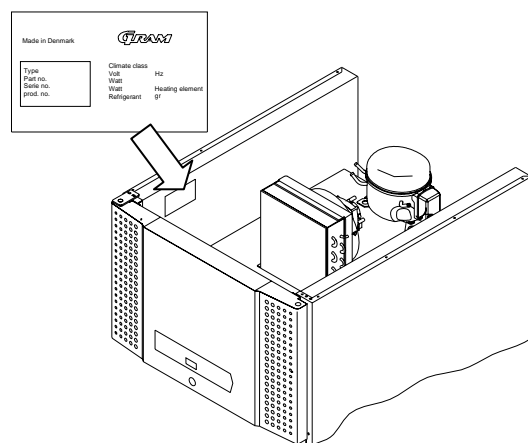

## Elimination

Lorsque vous vous débarrasserez de l'appareil usagé, veuillez le faire de façon correcte et respectueuse de l'environnement. Veuillez suivre la réglementation sur l'élimination en vigueur. Il peut y avoir des procédures/ des règles particulières à respecter.



**Gram Commercial NUF**

P.b. 44  
1970 Hemnes, Norway  
Tel.: 22 88 17 50  
Fax: 22 88 17 51

**Gram Deutschland GmbH.**

Holztorstraße 60  
31157 Sarstedt  
Tel.: 050-66 60 46 - 0  
Fax: 050-66 60 46 - 49

**Gram Commercial**

Box 5157  
217 24 Malmö, Sweden  
Tel.: 040-987848  
Fax: 040-987849

**Gram Nederland B.V.**

Bornerbroeksestraat 147  
Postbus 601  
7600 AP Almelo  
Tel.: 0546 454252  
Fax: 0546 813455  
e-mail: info@gram.nl

**Gram (UK) Ltd.**

2 The Technology Centre  
London Road, Swanley  
Kent BR 8 7AG  
Tel.: 01322 616900  
Fax: 01322 616901  
e-mail: info@gramuk.co.uk



Gram Commercial A/S  
6500 Vojens - Denmark  
Tlf.: +45 73 20 12 00  
Fax.: +45 73 20 12 01  
e-mail: info@gram-commercial.com  
www.gram-commercial.com

