

# **DOMINATORPLUS G31010TC Fan-assisted Range**



## **USERS INSTRUCTIONS**

### **SECTION 1 - GENERAL DESCRIPTION**

### **SECTION 2 - LIGHTING and OPERATIONS**

### **SECTION 3 - COOKING HINTS**

### **SECTION 4 - CLEANING and MAINTENANCE**

**This appliance has been CE-marked on the basis of compliance with the Gas Appliance Directive for the Countries, Gas Types and Pressures as stated on the Data Plate.**

The appliance **MUST BE** installed by a qualified person in compliance with the **INSTALLATION AND SERVICING INSTRUCTIONS** and National Regulations in force at the time. Particular attention **MUST** be paid to the following:

#### **Gas Safety (Installation & Use) Regulations**

#### **Health and Safety at Work Act**

Furthermore, if a need arises to convert the appliance for use with another gas, a qualified person must be consulted. Those parts which have been protected by the manufacturer **MUST NOT** be adjusted by the User.

Users should be conversant with the appropriate provisions of the Fire Precautions Act and the requirements of the Gas Safety Regulations. In particular the need for regular servicing by a competent person to ensure the continued safe and efficient performance of the appliance.

**WARNING - TO PREVENT SHOCKS, ALL APPLIANCES WHETHER GAS OR ELECTRIC, MUST BE EARTHED.**

Upon receipt of the User's Instruction manual, the installer must instruct the responsible person(s) of the correct operation and maintenance of the appliance. This equipment is **ONLY FOR PROFESSIONAL USE**, and shall be operated by **QUALIFIED** persons. It is the responsibility of the Supervisor or equivalent to ensure that users wear **SUITABLE PROTECTIVE CLOTHING** and to draw attention to the fact that, some parts will, by necessity, become **VERY HOT** and will cause burns if touched accidentally.



#### **WEEE Directive Registration No. WEE/DC0059TT/PRO**

At end of unit life, dispose of appliance and any replacement parts in a safe manner, via a licenced waste handler.

Units are designed to be dismantled easily and recycling of all material is encouraged whenever practicable.

### **Falcon Foodservice Equipment**

#### **HEAD OFFICE AND WORKS**

Wallace View, Hillfoots Road, Stirling. FK9 5PY. Scotland.

#### **SERVICELINE CONTACT**

Phone: 01438 363 000

Fax: 01438 369 900

T100758 Ref.1

## SECTION 1 - GENERAL DESCRIPTION

The G3101OTC is a dual fuel range with six open top gas burners on the hob and an electric fan convection oven.

**Hob burners are fitted** with individual flame failure devices to shut off gas supply to burners if flames are extinguished.

The oven is thermostatically controlled.

### Controls

All taps are the safety type with fixed HIGH and LOW settings. The markings are illustrated below.

### Open Top Gas Tap

Figure 1

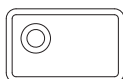
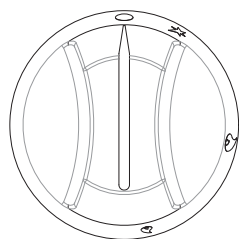
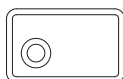

Figure 2



Each tap may be identified with the corresponding burner.

The electric control consists of a combined fan switch and thermostat. Two neons, one RED, one AMBER indicate Mains ON and Oven Heat ON respectively. The control knob is identified by the symbols shown in Figure 3 below.

### Oven Lights

The internal lights are controlled by a round black push button located on the control panel. Press and hold button to switch lights on. To switch off, release button.

### Oven Control Knob

Figure 3

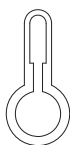
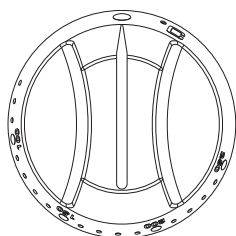

Figure 4



## SECTION 2 - LIGHTING and OPERATIONS

### Open Top

1. Ensure mains gas is turned on.
2. Press and turn knob to full flame position.
3. Light burner using taper or match and continue to hold knob in for a further 20 seconds before release.
4. Burner should remain lit; if burner goes out return to Step 1 and repeat ignition procedure.
5. When burner remains lit, turn knob to required position.

### To Shut Open Top Burner OFF

Turn knob to OFF position.

Using the Fryplate Accessory

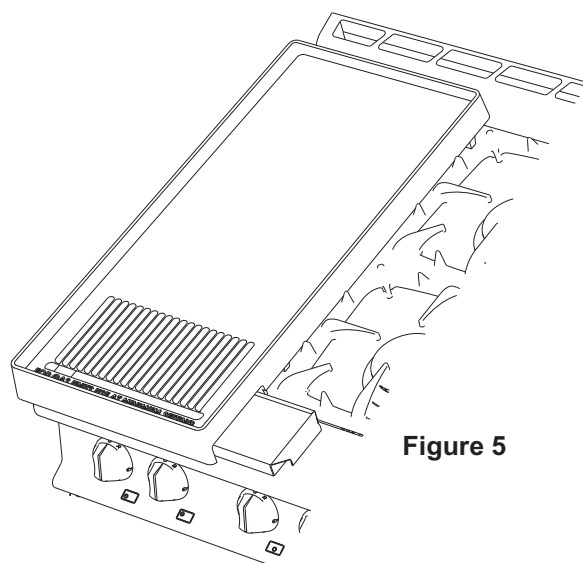

Figure 5

**Important Note - Caution:** This should only ever be used with hob burners on low flame setting.

The plate locates across any of the 3 banks of front and rear burners of the pan support casting.

A drain slot is located at plate front and a drainage tray slides below this from either side.

To remove or replace fryplate, lift it on and away from desired location as appropriate.

Allow plate to cool prior to any handling.

### Oven

1. Ensure mains electricity supply is on. Red neon will illuminate.
2. Turn control knob clockwise to desired setting. Amber neon will light and remain so until temperature is reached.
3. Never leave doors open for longer than is necessary to load or unload the oven.

### To Switch Oven OFF

Turn thermostat control to "O".

## SECTION 3 - COOKING HINTS

### Open Top

All open top burners are rated at 5.3kW nett.

The pan supports will safely accommodate pans from 125mm diameter (*minimum*) to 380mm diameter (*maximum*).

**It should be noted that it is not advisable to use 6 pans of maximum size as this will impede performance and combustion.**

**Note** - For maximum efficiency, place pan centrally over burner head and adjust control setting to avoid flames licking up pan sides.

### Oven

Temperature is automatically controlled by thermostat.

**Caution:** Opening oven door will result in the escape of heated air products. Care should be taken by users to avoid being burned by any such action.

### Grid Shelves

Two cooking shelves are supplied which can be supported in any of five different positions within the oven. When two shelves are used, these should be positioned with at least one single shelf space between them. Always push shelves in until stops hit the front of the supports.

### Tray Sizes

900mm wide oven will accommodate a 2/1 gastronorm tray.  
600mm wide oven will accommodate a 1/1 gastronorm tray.  
Single trays or dishes should be positioned centrally.  
Trays must not be allowed to overhang the shelf in any direction as this will adversely affect heat circulation.

### Pre-Heat Time

Allow at least 15 minutes from switching oven on from cold before loading with food. Insert dish quickly and close doors firmly.

The oven is fan assisted. Cooking temperatures should be lower than those of a conventional oven. Cooking times may also differ.

Five shelf positions are available.

Two shelves are supplied.

When using 2 shelves, we recommend that Positions 2 and 4 be used.

### Chef's Tips

Always pre-heat oven to desired temperature.

Use appropriate trays.

Do not over load oven.

Place food centrally upon the shelves.

Avoid opening oven doors during cooking process.

When removing food from oven, ensure that the doors are fully open.

### Cooking Chart

This information is provided as guidance only and all figures are approximate.

Food product	Temperature (°C)	Time (minutes)
Meringue shells	100	180
Shortbread biscuits	140	55
Croissants	170	25
Apple turnovers	180	35
Fairy cakes	200	15
Chickens	200	52
Vol-au-vent cases	210	18
Chicken pies	210	33
Fruit scones	220	13
Yorkshire puddings	220	30

Cooking times are dependant upon the following:

**Pre-heat Temperature**

**Food Temperature**

**(e.g. frozen, chilled or ambient)**

**Shelf Load**

**Oven Load**

**Size and weight of food**

**Personal Preference**

## SECTION 4 - CLEANING and MAINTENANCE

BEFORE ANY CLEANING OPERATION, ISOLATE ELECTRICITY AT THE MAIN SWITCH.

THE APPLIANCE MUST NEVER BE CLEANED WITH A JET OF WATER OR BE STEAM CLEANED.

All surfaces are easier to clean if spillage is removed before it becomes burnt on. It is advisable to clean the unit daily, after use.

### Stainless Steel Surfaces

These surfaces should be cleaned with hot water and detergent then dried and polished with a soft cloth.

Cleaning agents containing bleach, abrasives or caustic chemicals will damage or stain the stainless steel surfaces and must not be used.

### Vitreous Enamel Surfaces

Approved cleaning agents which have the Vitreous Enamel Development Centre (VEDC) mark are recommended.

It is advisable to clean daily after use. Wipe vitreous enamel surfaces clean while they are still warm using a soft cloth and hot soapy water. Badly stained, removable parts should be soaked in hot water with an approved detergent. Application of warm water using nylon or scotch cleaning pads with such detergent will give good results for non-removable parts.

### Open Top Burners

Burner cleaning should be carried out daily.

Burner efficiency will be significantly reduced if recommended cleaning is not carried out.

Remove pan supports and open top burner heads.

Wash all parts with hot soapy water according to detailed instructions enclosed at end of section.

After washing, dry all parts well and ensure all water is removed from inside burner head.

Wipe hob area. Hob tray may be lifted off for cleaning purposes and is secured by ball stud fixings at each corner. To lift away, pull tray up by gripping through burner cut-outs.

Replace parts in reverse order. Ensure that all parts are located correctly. The semi-sealed hob must be pushed down fully on ball stud fixings.

Dry pan supports by hand.

NEVER LEAVE THESE TO DRY NATURALLY.

## CLEANING INSTRUCTIONS for OPEN TOP BURNERS

Figure 6

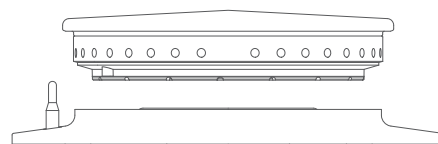

The following instructions should be followed when:

- A spillage has occurred on the burner.
- The burner fails to light or stay alight.
- At the end of each day or cooking period.

### Caution

Parts will be hot therefore protection to avoid burns should be used.

Figure 7

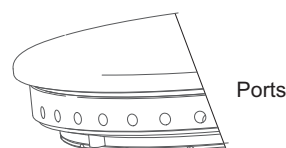

1. Remove pan support.
2. Remove burner head and bezel by lifting upward.
3. Thoroughly clean with soap and water. Ensure all burner ports are clean and free from food or cleaning material debris.

Figure 8

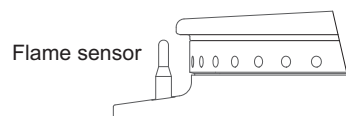

### Important

Stubborn debris lodged in ports (See Figure 4) can be removed using a non-metallic implement (ie. cocktail stick). The slots in base should be freed of debris using a soft brush. Dry burner with a lint-free cloth and blow through ports to ensure there is no blockage.

Figure 9

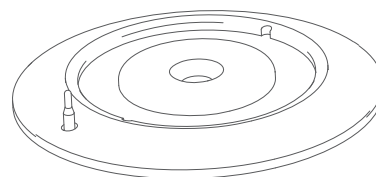

4. Clean any spillage from burner base, ensuring all food and cleaning material debris is removed. Dry burner base thoroughly, taking care not to damage flame sensor.

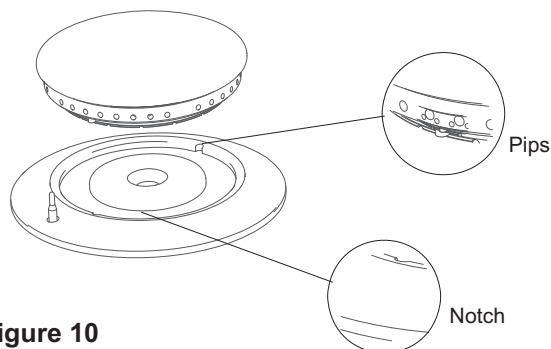

**Figure 10**

### **Important**

Do not allow any spillage or cleaning material debris enter the large hole in the burner base.

5. Replace burner head and aluminium bezel upon burner base and ensure head location pips sit within burner base notches. When burner head is properly located, it will not rotate.
6. Light burner to check that it operates correctly.

**Note:** Parts MUST BE dried thoroughly prior to re-lighting.

### **Note**

Follow this process prior to calling for a Service Engineer.

Failure due to lack of proper cleaning is not covered by warranty.

## **OVEN**

### **To Clean The Oven**

Clean while oven is warm but not hot. The enamelled base plate lifts out and runners can be removed (*grip at bottom, lift up until lower exit brackets, pull toward centre of oven and lower*).

### **Fitting the Fryplate**

The fryplate is designed to locate across any of the pan support castings on gas ranges.

The plate should be placed upon desired pan support with drain slot to front and the two underside bosses over each burner/boiling ring.

The drip tray can then be slid below plate from either side without disturbing fryplate.

### **Using the Fryplate - Gas Models Only**

**Note** - Fryplate should only ever be used with hob burners on a low flame setting.

Prior to use, the fryplate should be seasoned as follows:

- Wash surface to remove grease.
- Rinse and dry thoroughly before brushing liberally with frying oil.
- Cover with a layer of salt to a depth of 10mm.
- Turn on burners and heat until salt is golden brown, 1 – 2 Hours
- Remove salt without scratching plate
- Wipe surface thoroughly with a dry cloth
- The drip tray can get hot when in use and care should be taken when removing this.
- When cooking is over, ensure it has cooled prior to any handling

### **Cleaning the Fryplate**

The plate should be cleaned after use with hot soapy water. A scraper can be used to remove any burnt on deposits.