



WET BAIN MARIES

GBM2W/GBM4W/1885/1885FB/1985/1987/3015



British Built for Purpose.





Welcome to Parry

Parry is one of the UK's foremost manufacturers of high-quality Stainless Steel Fabricated Products with a 40-year heritage rooted in British craftsmanship.

At Parry, quality and service are second nature. Striving to exceed our customers' expectations is not just our motto; it's the very heartbeat of our business. Our commitment to our customers is reflected in the **Parry 4E Standard Inspection Body** stating that all our products are:



Easy to use



Easy to maintain



Easy to clean



Easy to repair

Our ranges of Stainless Steel Products have been specifically designed with the consumer in mind and are tailored and compliant to your specific industry sector. All our products are 4E Compliant and meet EU & UK regulations, where applicable. The Parry brand stands for quality, reliability and value.

Our British designed products have been created by our expert in-house development team and manufactured to exacting standards using Industry specified grade of European stainless steel and holding relevant EU & UK certification for all product.

ISO9001 certification and continual investment in the training and development of our highly skilled, artisan workforce means that our clients have genuine peace of mind that they are buying hand crafted, quality products supported by five-star customer service. All Parry products meet EU regulations for their respective sector.

We are LEAN manufacturers, minimising waste, maximising productivity. We are proud to run an operation that is committed to minimising our impact on the environment.

Our equipment and furniture are manufactured in our 45,000 sq ft manufacturing facility in Draycott, Derbyshire in England's industrial heartland. Products are made to order if not available in our stocked items which means you can choose from 600 products, offering over 3,500 variants, with short lead times to suit your specific needs. That means you get exactly what you need when you need it.

Our product information can be found here, in our brochure or on our website www.parry.co.uk.

You have my personal commitment that Parry will exceed your expectations. Should you have any questions please contact your distributor. Alternatively, our customer services team will be happy to help you on **01332 875544**.

Mark Banton MBA
Managing Director



Contents

Contents.....	1
Product Overview	2-4
Safety Instructions	5
Installation Instructions	5
Operating Instructions	6
Cleaning Instructions	7
Maintenance Instructions.....	7
Fault Finding	8
Service Information.....	9
Wiring Diagram	10
Exploded View.....	11-17
Parts List	18-21
Warranty Information.....	22
Disposal & Recycling	23

Parry Catering Equipment (Midlands) Ltd, Town End Road, Draycott, Derby, DE72 3PT.

Sales Tel: 01332 875544

Fax: 01332 874455



Product Overview

GBM2W

Strong and reliable, the Parry GBM2W electric wet bain marie keeps pre-cooked foods and liquids at ready-to-serve temperatures. Constructed from high grade stainless steel, it is capable of holding 2 x 1/4 gastronorm pots.

GBM4W

Functional and reliable, the Parry GMB4W wet bain marie is the perfect solution for keeping pre-cooked foods at ready-to-serve temperatures. Incredibly versatile, the unit can accommodate up to 4 x 1/4 gastronorm pots. The simple thermostat controls and stainless steel construction help to ensure that the bain marie is easy to use, clean and maintain.

1885

The Parry 1885 electric wet bain marie has a strong stainless steel construction. Designed specifically for stand alone use, holding precooked foods and liquids at a temperature ready to be served. This unit can hold three x 1/3 gastronorm pots.

1885FB

Versatile and reliable, the countertop Parry 1885FB electric wet bain marie is perfectly suited to commercial environments such as takeaways, restaurants and pubs. With full size (1/1) gastronorm compatibility, the bain marie can also be configured to accept third sized (1/3) gastronorms, providing additional serving options. Ideal for holding precooked foods at safe, ready-to-serve temperatures, the bain marie is suitable for gravy, curry and chilli. Constructed from stainless steel for durability, the front-mounted drain valve ensures ease of cleaning at the end of service.



Product Overview

1985

With its high capacity, the Parry 1985 wet well bain marie is a versatile and functional water bath perfectly suited to commercial catering. Made from high quality stainless steel, this commercial bain marie has an easy-drain valve and precise thermostat control. Ideal for keeping pre-cooked foods and sauces at safe and ready-to-serve temperature, it's durable and easy to clean.





1987

Attractive and compact, the Parry 1987 bain marie is the perfect way to store pre-cooked foods at safe, ready-to-serve temperatures. With wet heat configurations, the bain marie is ideal for food ranging from curry and gravy to chips and vegetables. It has the capacity for 2 x 1/1 gastronorm pots or 6 x 1/3 gastronorm pots.

3015

Keep pre-cooked foods at safe, ready-to-serve temperatures with the Parry 3015 electric wet bain marie. Reliable and consistent, the bain marie is supplied with four x 4 litre pots and lids, ideal for baked beans, chilli, curry and gravy. The high grade stainless steel construction ensures that the unit is robust and easy to clean, whilst the variable temperature controls are responsive and easy to use. This commercial bain marie is perfect for a range of professional catering establishments, from takeaways to schools, restaurants and mobile caterers.

These units lead the industry in:

-  Design and aesthetic appeal
-  Performance
-  Power
-  Functionality
-  After sales support



Product Overview

Features	GMB2W	GBM4W	1885	1885FB	1985	1987	3015
Unpacked weight (kg)	12	12	12	12	16	16	17
Packed Weight (kg)	15	15	15	15	21	21	21
Dimensions (w x d x h) mm	270 x 340 x 230	535 x 340 x 230	545 x 350 x 300	340 x 560 x 300	660 x 560 x 300	1090 x 350 x 275	450 x 525 x 255
Pot capacity	Up to 1 x ½ GN	Up to 4 x ¼ GN	Up to 3 x 1/1 GN	Up to 3 x 1/1 GN	2 x 1/1 GN	2 x 1/1 GN	4 x 4 litre
Wet or dry	Wet	Wet	Wet	Wet	Wet	Wet	Wet
Plug	Yes	Yes	Yes	Yes	Yes	Yes	Yes
Power rating	3kW	3kW	3kW	3kW	3kW	3kW	3kW
Warranty	2 years	2 years	2 years	2 years	2 years	2 years	2 years



Safety Instructions

IMPORTANT PLEASE READ INSTRUCTIONS FULLY BEFORE USE



WARNING

To avoid scratching the highly polished exterior surface of this equipment whilst in transit, the protective film on the exterior surfaces has NOT been removed.

It is IMPORTANT that this protective film is peeled off before the equipment is used.









Installation Instructions

-  Choose a suitable site for your machine taking into consideration its, use and any heat that may be generated whilst in service.
-  Remove all protective film and packaging materials and inspect for any damage which may affect the machines electrical safety.
-  All appliances with an electrical loading above 3 kilowatts must be connected to a suitable supply by a qualified electrician, who should ensure that:







Operating Instructions

DO NOT USE THESE MACHINES FOR COOKING PURPOSES



-  Ensure the drain tap is in the closed position where fitted
-  Fill the tank with water until it reaches just below the bottom of the pots
-  Turn on the power supply, the red lamp will illuminate to indicate the power is on
-  Turn the thermostat dial to the required setting, the green lamp will show indicating that there is power to the element
-  When the desired temperature is reached the green lamp will extinguish, this procedure will be repeated automatically as the thermostat maintains a constant temperature.
-  Fill the containers with hot food and replace the covers.
-  The water content inside the tank must be monitored and topped up as required, never let the water drop below the level of the element.

WATER CHANGING ON MACHINES FITTED WITH A DRAIN

ALWAYS SWITCH OFF THE MACHINE AND ISOLATE FROM THE MAINS SUPPLY BEFORE CHANGING THE WATER.

-  Unscrew the bung fitted to the drain tap and connect the drain spout provided.
-  Place a suitable receptacle underneath the spout
-  Lift the locking device and slide the drain tap across
-  After draining slide the tap back across and replace the bung







ON MACHINES WITHOUT DRAINS FITTED

-  Turn off power supply
-  Tip machine upside down to empty



Cleaning Instructions

The appliance should be cleaned after every use.

-  Allow unit to cool down before cleaning
-  Turn off unit at the mains power.
-  With the containers removed wipe down the machine with a soft cloth, do not use abrasive materials.
-  Clean the tank on a regular basis to avoid scale build up, which could reduce the life of the element.
-  If scale has built up, use a suitable descaling fluid or powder, and follow product instructions.
-  Stainless steel cleaners maybe used and cleaning instructions on the product must be adhered to.
-  Never clean the unit with water jets.



Maintenance Instructions

Ensure the appliance is isolated from the power supply before installing, cleaning or maintaining the appliance.

Maintenance and service must only be undertaken by a qualified electrician.



Parry Catering provides a complete after-sales service by offering the sales of spare parts directly to customers. Buying spares straight from the manufacturer allows customer to experience exceptional value and speedy delivery on all spare parts.

For more information on buying spares visit:

www.parry.co.uk/parry-commercial-catering-spares



Fault Finding

Fault	Check	Solution
Mains light does not illuminate	<ol style="list-style-type: none">1. Check the unit is plugged in to the mains supply.2. Check the socket is switched on3. Try a different socket in the appliance4. Try a different socket5. Check the fuse in the plug	If the problem remains, please contact your distributor
Unit not reaching temperature	Check water levels as the unit has a built-in thermal cut-out to disable the element should water levels become too low	Re-fill the water tank. If the problem remains, please contact your distributor



Service Information

This appliance should be routinely serviced to prolong its lifetime. Parry recommends that the appliance is serviced every 12 months by a Parry authorised engineer. Failure to service your product within the initial 12 month warranty period will cause the 24 month warranty to become void.

If the supply cord becomes damaged, it must be replaced by the manufacturer, it's service agent, or a similarly qualified person.

Enhanced 2 Years Warranty

Parry Catering (Midlands) Ltd offer an enhanced warranty of two years (including parts and labour) on all of the Parry manufactured products. To take advantage of this you should register your warranty by logging onto the company website and filling out our simple form.

www.parry.co.uk/the-parry-warranty

If you have any issues with your product and wish to request a warranty call you can contact our friendly team who will organize a Parry approved service engineer to attend and fix your problem.

All warranty requests can be sent to warranty@parry.co.uk alternatively call our warranty department for technical assistance on **01332 875544**





Wiring Diagram

GBM2W / GBM4W / 1885 / 1885FB / 1985 / 1987 / 3015

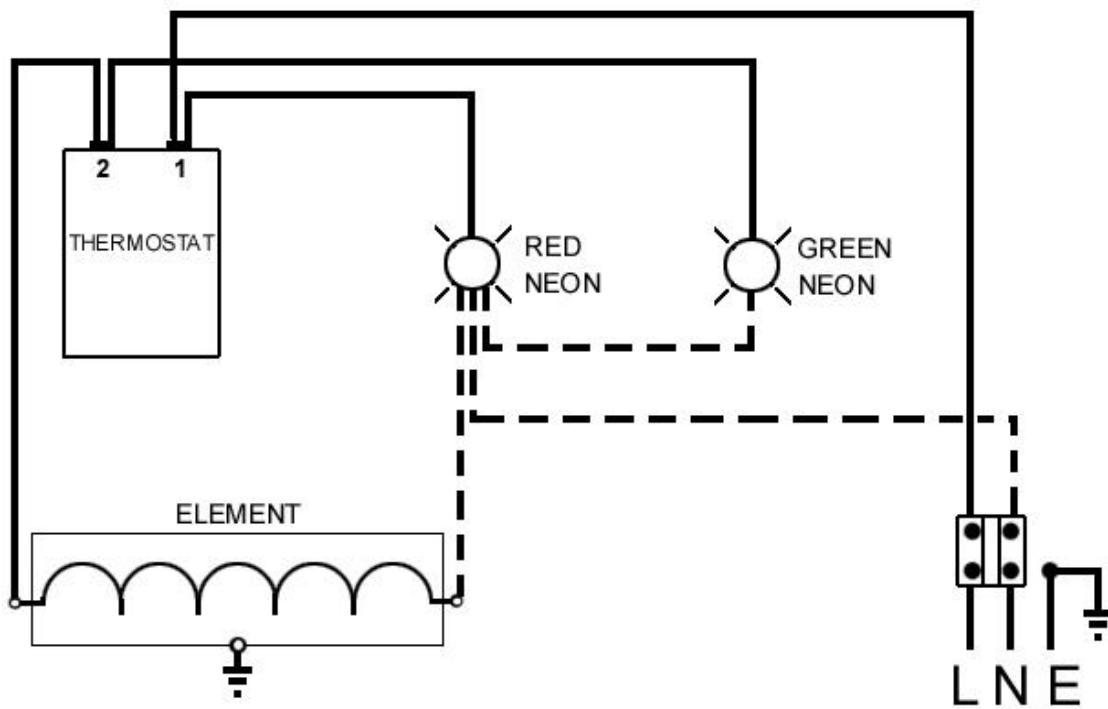



Exploded View

GBM2W

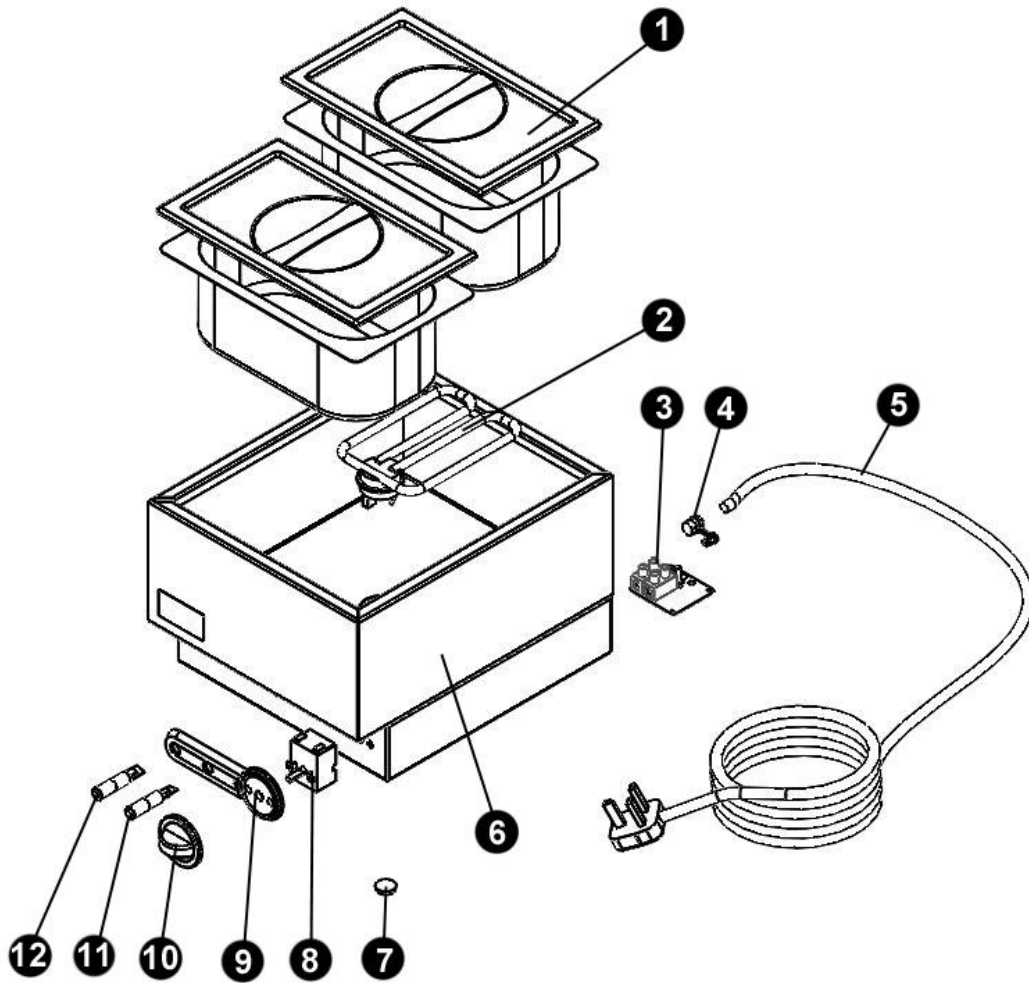

Parry-British Built for Purpose

IN124-2



Exploded View

GBM4W

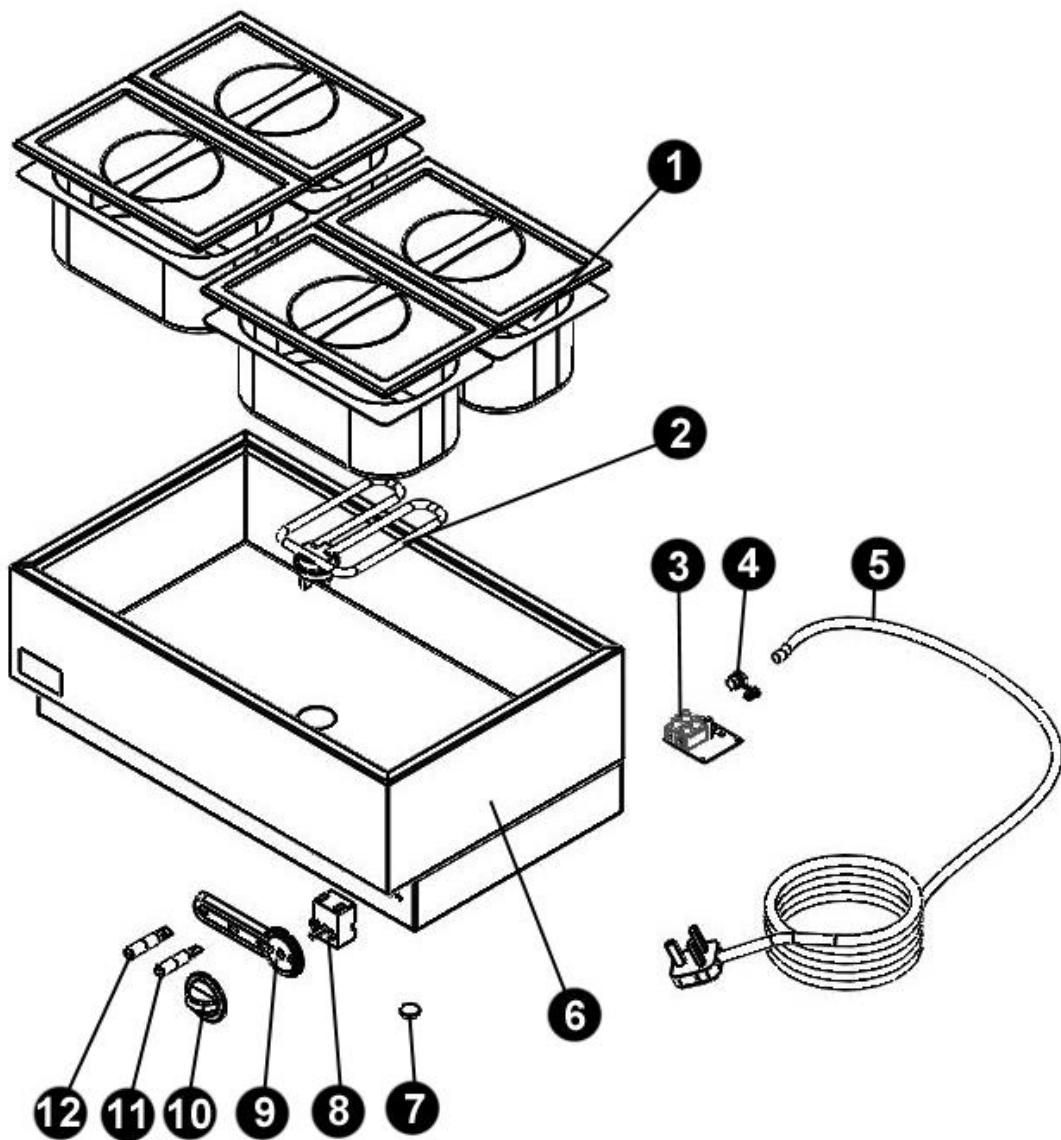

Parry-British Built for Purpose

IN124-2



Exploded View

1885

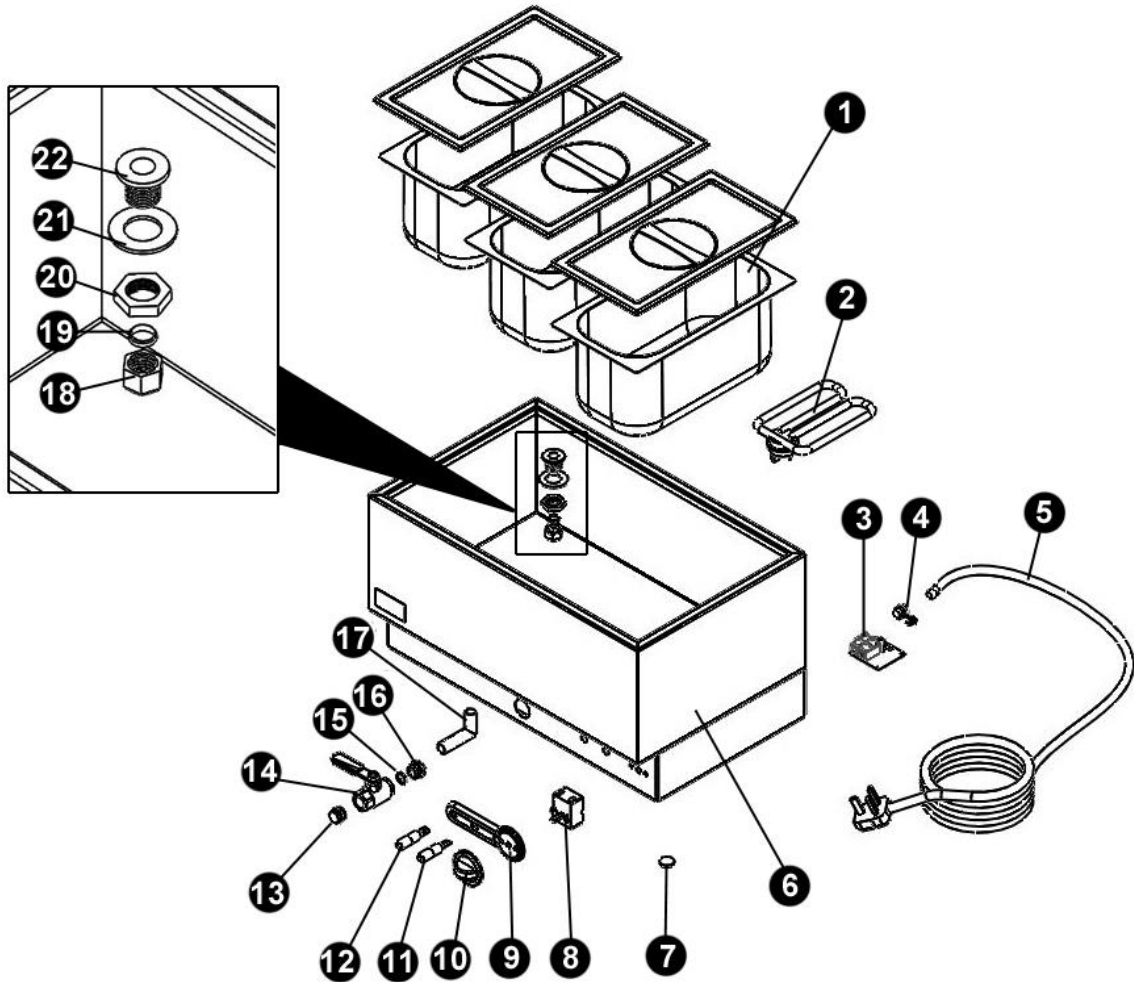

External Drain Tube Assembly

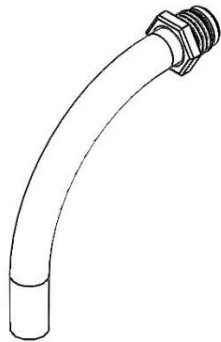



Exploded View

1885FB

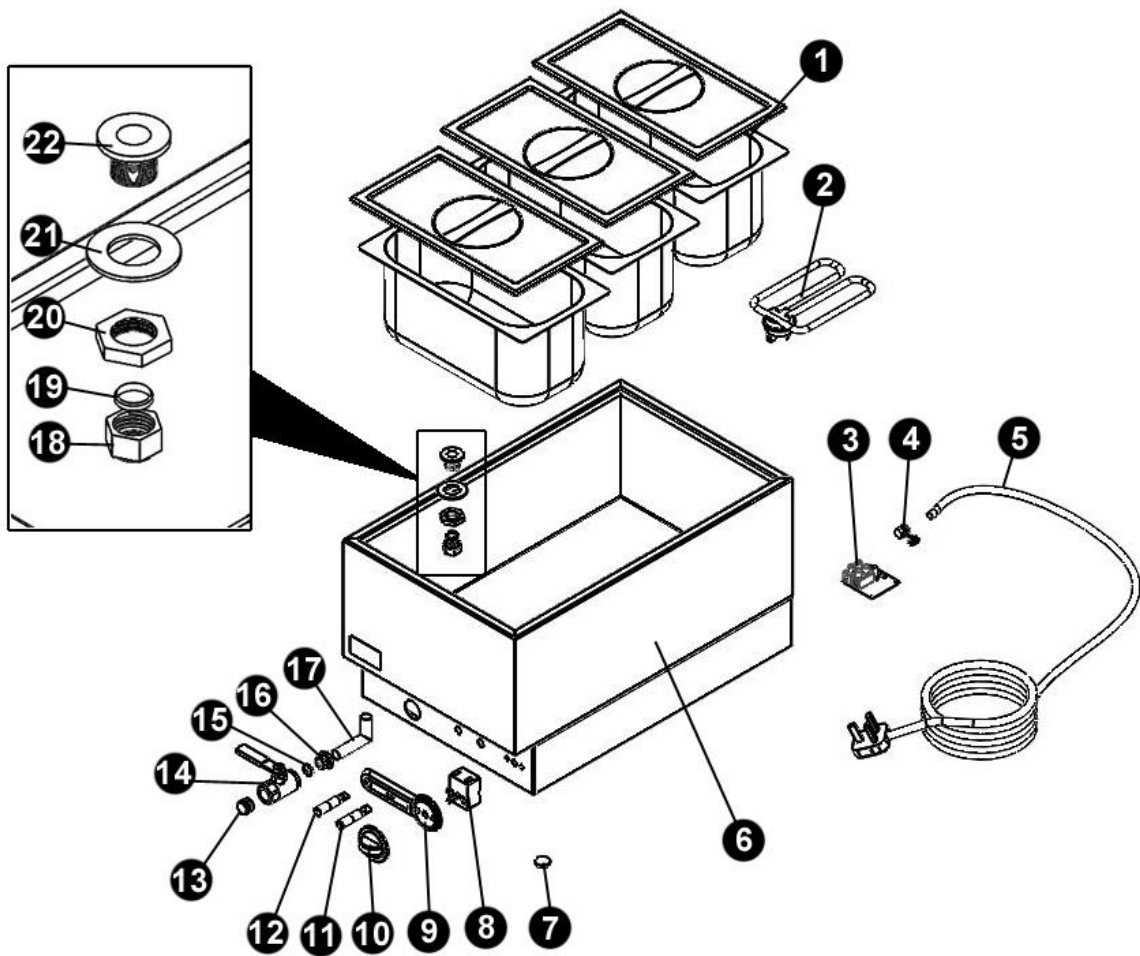

External Drain Tube Assembly

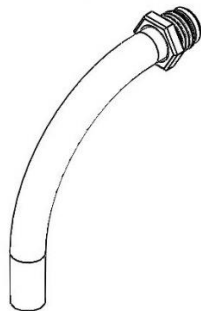

Parry-British Built for Purpose



Exploded View

1985

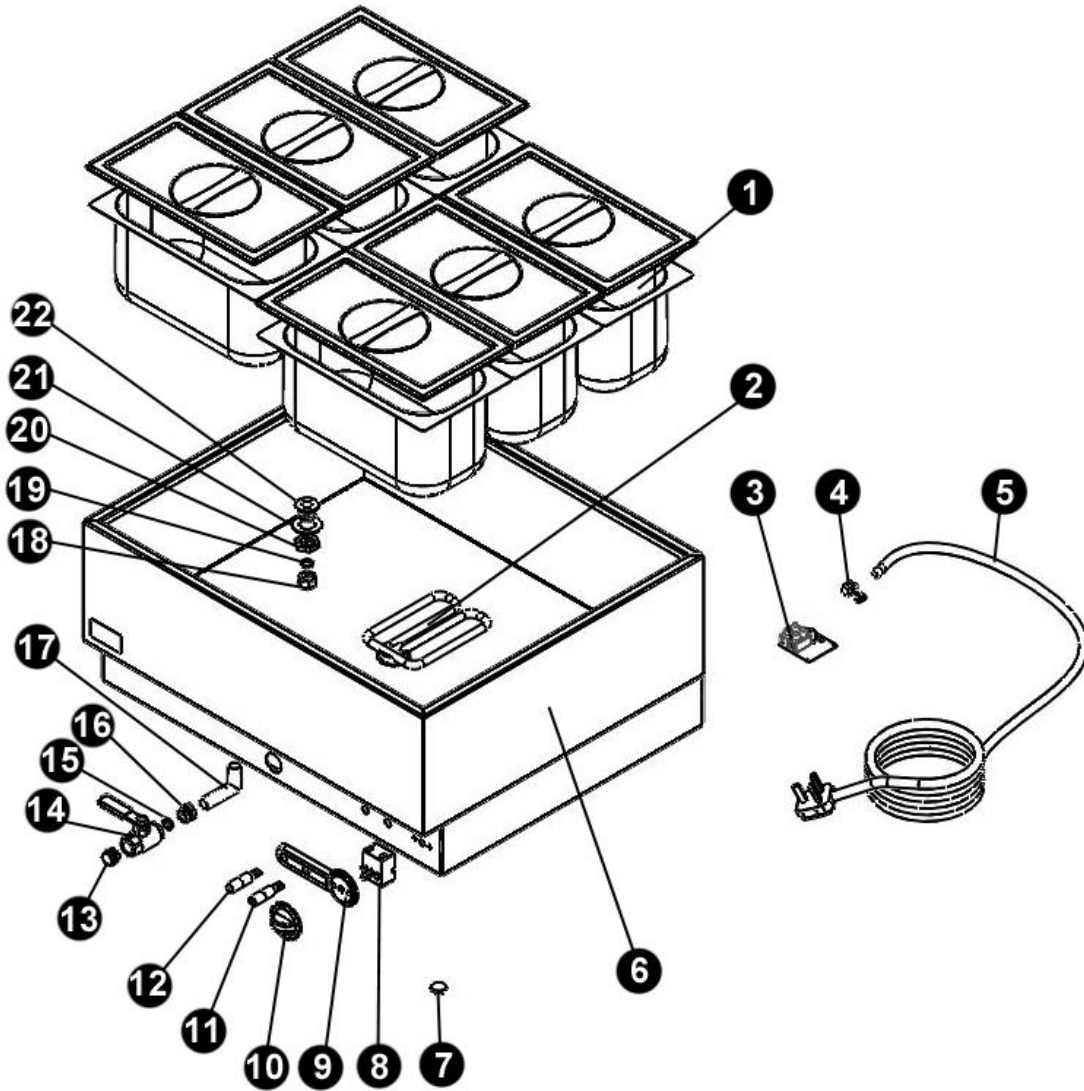

External Drain Tube Assembly

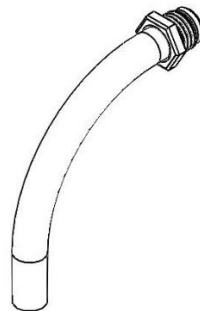

Parry-British Built for Purpose

IN124-2



Exploded View

1987

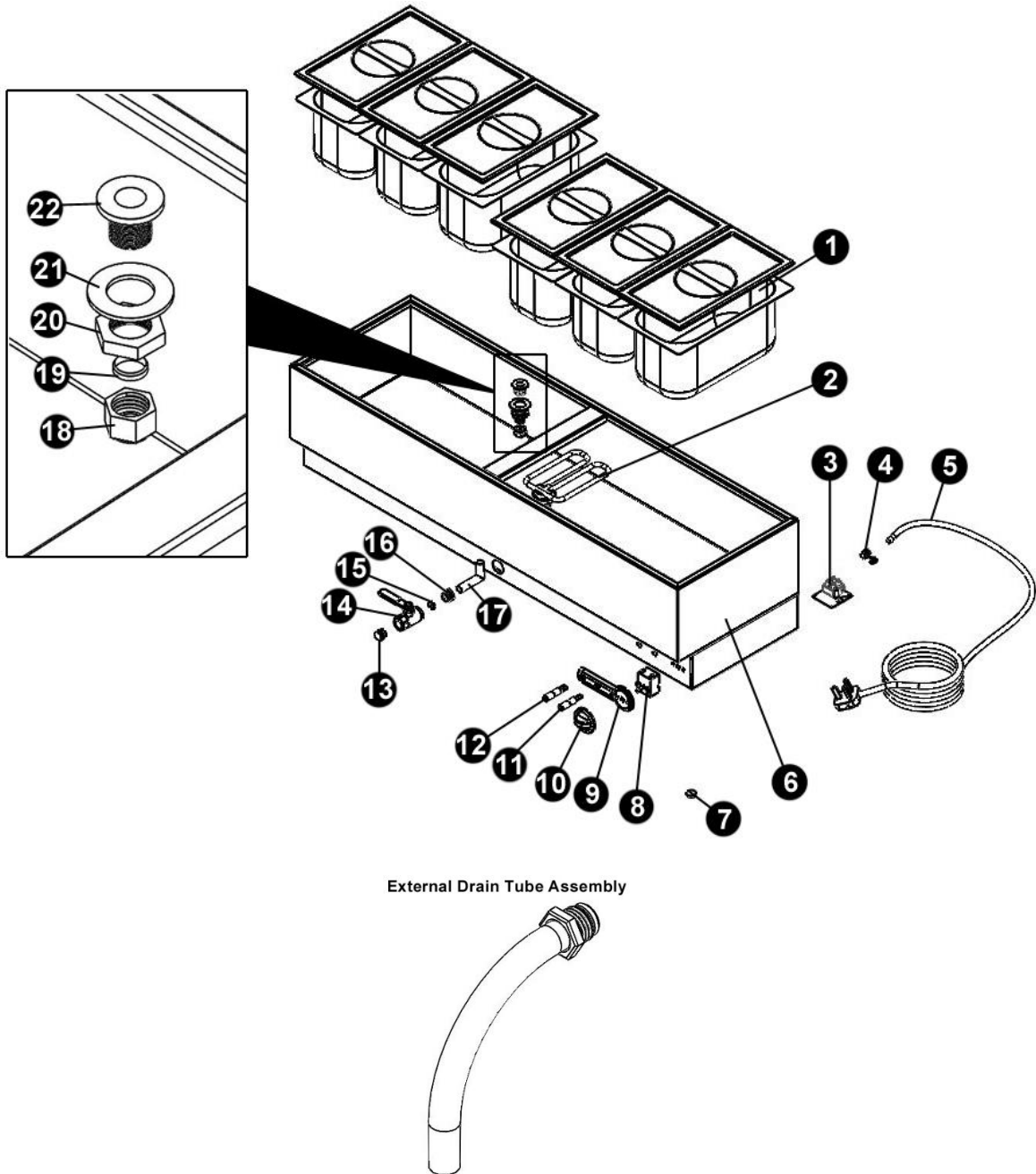



Exploded View

3015

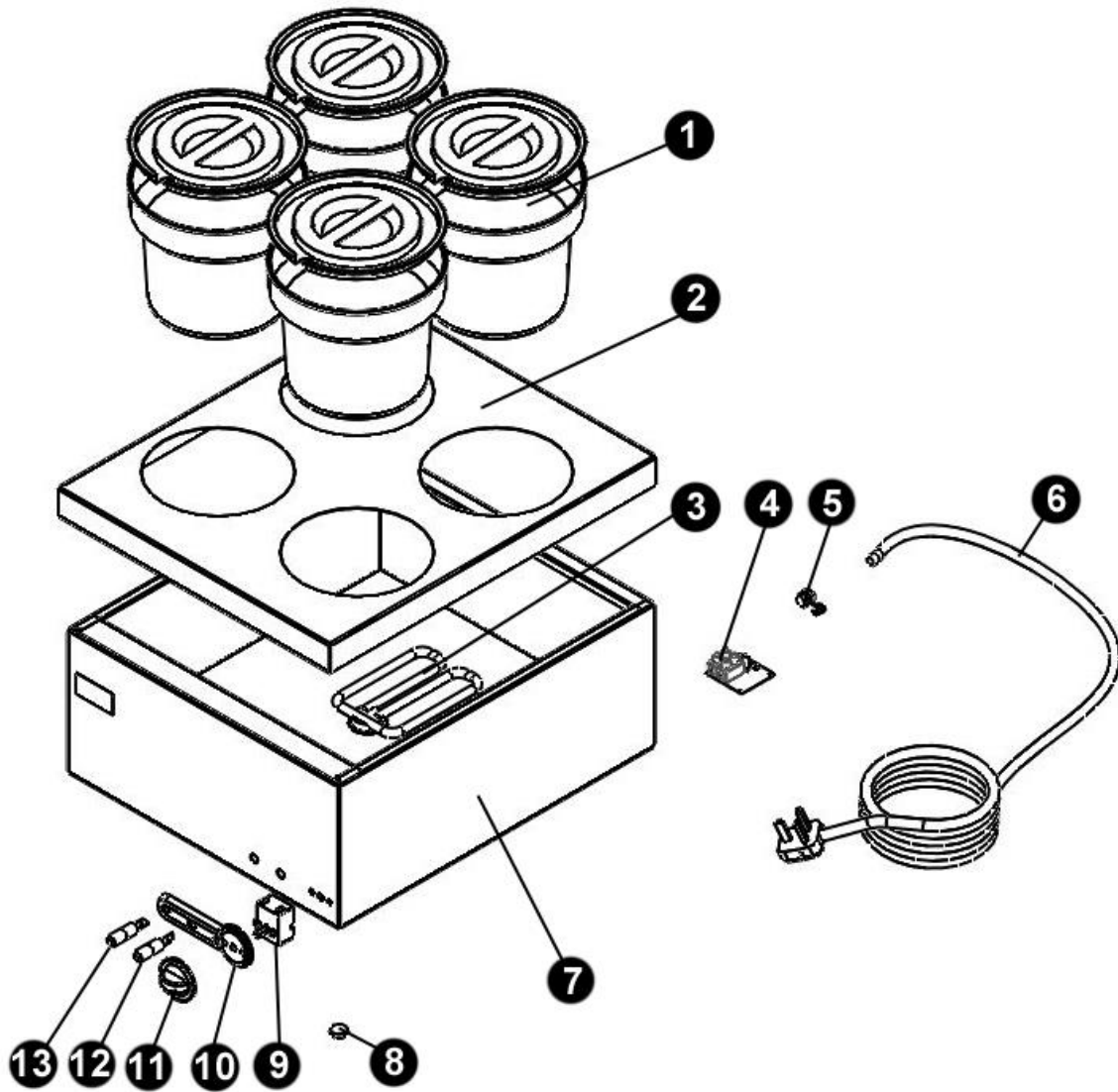

Parry-British Built for Purpose

IN124-2



Parts List

GBM2W / GBM4W

Part Number	Description	Code GBM2W	Code GBM4W
1	¼ 100mm Depth Gastronorm and Lid	BAMA40100	
2	Element	ELBW03000	
3	Terminal Block	TERMBRKT1	
4	Cable Bush	BUSR06003	
5	Mains Lead	MAINSLEAD	
6	*Body	*No Code	*No Code
7	Rubber Foot	RUBBRFOOT	
8	Thermostat	TMST5513015	
9	Bezel	BEZELCBOX	
10	Control Knob	KNOBTYPED	
11	Red Neon	LNRE2211P	
12	Green Neon	LNGN2211P	

*Metalwork Components



Parts List

1885 / 1885FB

Part Number	Description	Code 1885	Code 1885FB
1	⅓ 150mm Depth Gastronorm and Lid	BAMA30150	
2	Element	ELBW03000	
3	Terminal Block	TERMBRKT1	
4	Cable Bush	BUSR06003	
5	Mains Lead	MAINSLEAD	
6	*Body	*No Code	*No Code
7	Rubber Foot	RUBBRFOOT	
8	Thermostat	TMST5513015	
9	Bezel	BEZELCBOX	
10	Control Knob	KNOBTYPB	
11	Red Neon	LNRE2211P	
12	Green Neon	LNGN2211P	
13	Drain Valve Plug	PLUGBSP12	
14	Drain Valve	VALVEB12N	
15	15mm Olive	OLIVE0015	
16	½" BSP Male Tube Nut	NUTMBSP12	
17	*Internal Drain Tube	*No Code	
18	½" Female Compression Nut	Part of item 13	
19	15mm Olive	Part of item 13	
20	Bowl Insert Nut	NUT4BOWLSSS	
21	Washer	*No Code	
22	Bowl Insert	BOWLINSSL	
	External Dain Tube CW	COPPERBEND01	
		OLIVE0015	
		NUTMBSP12	

*Metalwork Components

Parry-British Built for Purpose



Parts List

1985 / 1987

Part Number	Description	Code 1985	Code 1987
1	⅓ 150mm Depth Gastronorm and Lid	BAMA30150	
2	Element	ELBW03000	
3	Terminal Block	TERMBRKT1	
4	Cable Bush	BUSR06003	
5	Mains Lead	MAINSLEAD	
6	*Body	*No Code	*No Code
7	Rubber Foot	RUBBRFOOT	
8	Thermostat	TMST5513015	
9	Bezel	BEZELCBOX	
10	Control Knob	KNOBTYPB	
11	Red Neon	LNRE2211P	
12	Green Neon	LNGN2211P	
13	Drain Valve Plug	PLUGBSP12	
14	Drain Valve	VALVEB12N	
15	15mm Olive	OLIVE0015	
16	½" BSP Male Tube Nut	NUTMBSP12	
17	*Internal Drain Tube	*No Code	
18	½" Female Compression Nut	Part of item 13	
19	15mm Olive	Part of item 13	
20	Bowl Insert Nut	NUT4BOWLSSS	
21	Washer	*No Code	
22	Bowl Insert	BOWLINSSL	
	External Dain Tube CW	COPPERBEND01	
		OLIVE0015	
		NUTMBSP12	

*Metalwork Components

Parry-British Built for Purpose



Parts List

3015

Part Number	Description	Code
1	¼4 Litre S/S Round Pot and Lid	BAMA00018
2	*Top	*no Code
3	Element	ELBW03000
4	Terminal Block	TERMBRKT1
5	Cable Bush	BUSR06003
6	Mains Lead	MAINSLEAD
7	*Body	*No Code
8	Rubber Foot	RUBBRFOOT
9	Thermostat	TMST5513015
10	Bezel	BEZELCBOX
11	Control Knob	KNOBTYPB
12	Red Neon	LNRE2211P
13	Green Neon	LNGN2211P

*Metalwork Components



Warranty Information

The manufacturer's warranty is only valid in the UK mainland. Northern Ireland, Western Isles, Inner Hebrides and Islands are parts only warranty. Please be aware that the warranty starts from the date of purchase from Parry and not the sale or installation date of the equipment.

To be eligible for a 2 year warranty, products must be serviced at least once within the first 12 months of purchase.

All service calls will be carried out between 8am and 5pm, Monday to Friday.

Your warranty is invalid if your equipment has not been installed in accordance with the manufacturer's instructions. The misuse, alteration or unauthorised repairs of the equipment will also invalidate the warranty.

During the warranty period it is at Parry's discretion whether to repair or replace the equipment. The warranty only applies if the equipment has been used in a professional manner following the manufacturer's instructions and maintenance guidelines.

The warranty covers defects in the material and component failure only. We are not liable for trading loss, loss of perishable items, water damage or loss due to injury or fire damage.

Please ensure you have referred to the manufacturer's instruction before placing a warranty call.

Contact our warranty department on **01332 875544** for technical assistance.











Please have your model number ready before calling.

All warranty requests must be submitted to warranty@parry.co.uk.

Failure to pay any warranty charges will result in your warranty being put on hold until the bill has been settled. Any issues regarding the raised charges should be put in writing to our warranty department for further investigation.

Register your product by visiting our website www.parry.co.uk

Not covered under warranty

-  Fault due to incorrect installation, poor maintenance or equipment abuse.
-  Resetting of equipment or circuit breakers.
-  Faulty electrics – e.g. customer's plug socket, plug, wiring, junction box fault, wrong fuse.
-  Products must be serviced within the first 12 months to be eligible for the 2 year warranty
-  Product not covered by warranty if combustible materials have been used, e.g. plastic trays.
-  Foil used on racks, blockages and lime scale issues.
-  Failure to grant access for pre-arranged service call.
-  Equipment that has been set up or used incorrectly e.g. dishwasher detergents, levelling and setting up of doors on a six burner cooker.
-  Excessive carbon build-up on griddle plates or overuse of lava rock on chargrills. (Recommended use by Parry no more than 2kg.)
-  All of the above points are not covered by warranty and any costs incurred, because of the above, will be forwarded to the parties responsible for placing the call.



Disposal & Recycling

This appliance is marked according to the European Directive 2002/96/EC on Waste Electrical and Electronic Equipment (WEEE).

By ensuring this product is disposed of correctly, you will help prevent potential negative consequences for the environment and human health which could otherwise be caused by inappropriate waste handling of this product.

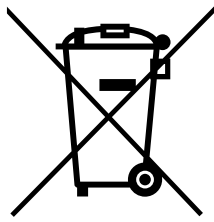

A symbol on the product, or on the documents accompanying the product, indicates that this appliance may not be treated as household waste. Instead it should be handed over to the applicable collection point for the recycling of electrical and electronic equipment.

Disposal must be carried out in accordance with local environmental regulations for waste disposal.





For more detailed information about treatment, recovery and recycling of this product, please contact your local city office, your household waste disposal service or the shop where you purchased the product.

Parry Catering recognises our obligations to the EU DIRECTIVE covering the waste disposal of electrical and electronic equipment (WEEE). Parry Catering are committed to this policy in order to help conserve the environment.

At the end of this unit's life you **MUST** dispose of it in an approved manner. You **MUST** not discard the unit or place it in the refuse bin.

You have several options:

-  Take the unit to an approved WEEE scheme company, there will be one in your area.
-  Take the unit to an approved waste disposal site; many sites are managed by your local authority.
-  Contact the units manufacturer, importer or their agent; the contact details will be on the unit.

There will probably be a charge for this service which will depend on the physical size and location of the unit. You will be given a collection price for a curb side collection based on commercial rates prevailing at the time.

It should be noted that the unit to be collected should be suitably packed and sealed to prevent dangerous gases and fluids from escaping. The condition of the unit must also be clean to comply with health and safety regulations.