

Lec⁺

USER GUIDE

LeC Start-up Guide

- ▶ **REMOVE ALL PACKAGING** external and internal from the appliance including any strips of adhesive tape, plastic bags and pieces of packing foam from inside the cabinet.
- ▶ **THE RIGHT LOCATION** Do not place your appliance in direct sunlight or close to a heat source such as radiators. The appliance should not be placed in a room where the ambient temperature is above or below that for which the product was designed to operate in. This can be checked by looking at the data plate, located inside the cabinet. Class SN has an ambient temperature range of 10 to 32°C, class N has a range of 16 to 32°C, class ST has a range of 18 to 38°C and class T has range of 18 to 43°C. Make sure there is adequate ventilation all around the cabinet, ensuring there is gap of 50mm around the sides, 75mm at the rear and 25mm at the top.
- ▶ **LEVELLING THE APPLIANCE** Make sure the cabinet does not 'rock' and that it stands level.
- ▶ **LET THE COOLANT SETTLE** Prior to switching on, leave your appliance to stand for 2 hours to allow the coolant fluid time to settle.
- ▶ **BEFORE YOU PLUG IN AND SWITCH ON** Check that the voltage of the appliance is the same as your supply, the voltage of the appliance will be found from the data plate situated inside the cabinet
- ▶ **DOOR OPENING** In order to maintain the correct temperatures inside your appliance, keep door opening to a minimum and do not leave the door standing open

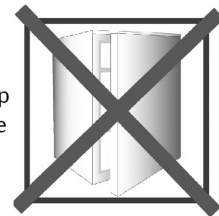
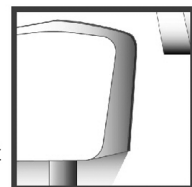
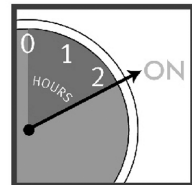
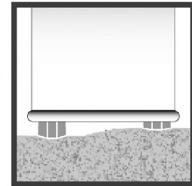
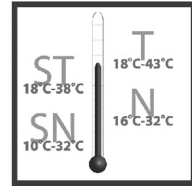
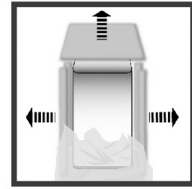

CLEANING YOUR APPLIANCE

Your cabinet is easy to keep clean. Regular cleaning is important for hygiene reasons. Before attempting any type of cleaning, always switch off the appliance and pull out the mains plug.

Exterior:

Use a good wax furniture polish to clean your cabinet's exterior. Make sure that the doors are closed, to prevent polish getting on the magnetic door seal or inside. Do not use an aerosol polish as the spray may damage plastic parts. The condenser (black grille at the back) can be vacuumed using a soft brush attachment.

Interior:

Before using for the first time, and periodically, the interior of your appliance should be cleaned. Remove all drugs, vaccines samples etc. from the cabinet and store them in a controlled temperature environment so. Remove all the shelves, baskets and door fittings. Wipe the inside with a soft cloth dampened with lukewarm water mixed with a little mild detergent. Rinse with clean warm water and dry thoroughly. Avoid water getting into any electrical fittings, switches, lights etc. as this may cause serious electrical damage.

The magnetic door seal may be cleaned using warm soapy water and then dried thoroughly.

Do not use wire wool, solvents, scouring powders or disinfectants of any kind.

After cleaning, plug in and switch on the appliance.

STORAGE

Air has to circulate freely around the interior of the cabinet, so shelves must not be covered with paper. Wherever possible, leave spaces between packages and containers.

Pharmacy Refrigerators (PE/PG models) are suitable for the storages of medicines,

vaccines, pharmaceutical stock and preparations which require a storage temperature between +2°C and +8°C.

Ward Refrigerators (WR models) operate between +1°C and +5°C and are suitable for the storage of fresh food and beverages

Laboratory refrigerators (LR/ISR models) are suitable for the storage of volatile liquids, reagents, chemicals, poisons and samples and preparations which require a storage temperature between +2°C and +10°C.

INTERNAL FAN

PE/PG/WR models have an internal fan fitted. The vents to the fan housing, at the top of the compartment should not be blocked. This allows air to circulate freely around the internal chamber.

CASTORS

The PE/PG1607 has castors fitted as standard. The front 2 castors can be locked in order to prevent the cabinet from moving.

USEFUL HINTS

If your appliance is to be out of service for any length of time ensure that the interior is carefully cleaned and dried. Leave the door open and disconnect the plug from the mains socket.

Carry out regular cleaning according to instructions.

See that vibration noises are not caused by objects in contact with your appliance and each other.

Don't pack shelves too tightly or obstruct even distribution of cold air.

DOORS

On PE/PG/LR 207 and ISR27 models the doors are reversible, i.e. a right handed door can be turned into a left handed door. To do this, proceed as follows:

Remove shelves and containers from within the cabinet. Carefully lay the cabinet onto its back, preferably onto something soft such as a dust sheet to prevent scratching to the floor and the cabinet.

Unscrew the adjustable foot (if applicable). Remove the two screws from the lower front hinge and the front foot or the adjustable foot plate. Remove the lower hinge from the door.

Slide the door towards the base of the cabinet, thus disengaging the top hinge pin from the location hole in the top of the door.

If the cabinet has a door handle, unscrew the two screws holding it in place. Locate the two hole blanking screws on the other side of the door and remove. Re-attach the handle and the hole blanking screws in their new positions

Unscrew the two screws holding the top hinge bracket, swap the position of the bracket to the other side of the cabinet and re-attach.

Slide the door onto the top hinge pin. Insert the lower hinge pin into the door. Screw the hinge in place together with the front hinge foot (if applicable) which should be fixed so that the screw is towards the back of the cabinet. Attach the front feet or the adjustable foot plates and adjustable feet. Stand the cabinet upright and check that the door is correctly aligned and that the magnetic seals fit snugly all round and that there are no gaps. If adjustments are necessary, lay the cabinet onto its back and alter the position of the lower hinge.

WALL MOUNTING

The 107 and 207 size models (optional extra on 207 models) can be wall mounted. The 107 cabinets have mounting holes already in the back wall of the cabinet, the 207 size models are factory fitted with wall mounting brackets when this option is ordered. No. 10 x 40mm round head securing screws are recommended for fixing the cabinet to the wall.

Before wall mounting the cabinet ensure that the wall is sound and will take the weight of the cabinet and its contents.

When the standard mains lead is used, the bottom of the cabinet should not be more than 1 m above the electrical supply socket.

107 SIZE MODELS

Mark out and drill the wall according to the dimensions given in the following diagram. Insert rawl plugs if necessary. Fix the two upper screws into the wall so that the screws are protruding 5 mm from the wall to the underside of the screw head. Lift the cabinet and position it so that the two keyhole slots drop over the screw heads. Screw in the two lower screws.

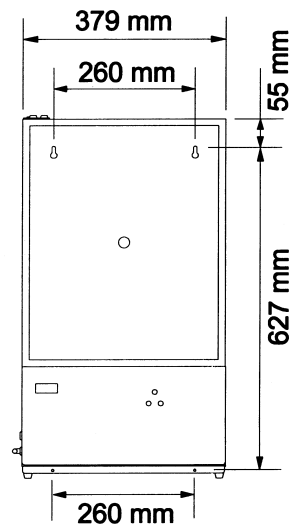

207 SIZE MODELS

Mark out and drill the wall according to the dimensions given in the following diagram. Insert rawl plugs if necessary. Align the cabinet mounting holes to the screw positions or rawl plugs and hold the cabinet in position e.g. by standing it on a table. Screw in the four screws to fix the cabinet

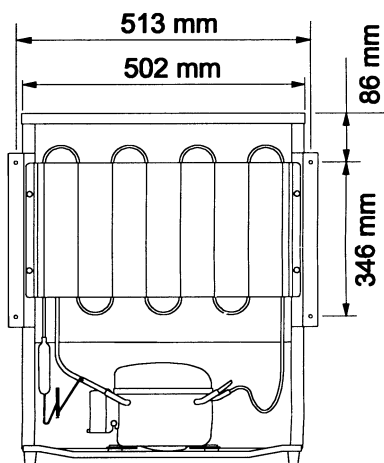

INTERNAL LIGHT REPLACEMENT (Glass door models only)

Models fitted with glass doors have an internal fluorescent light that can be switched on and off using the switch located on the right hand side of the light housing. Should the fluorescent tube need replacing first turn off the power supply and remove the plug from the socket. The light cover is made from a flexible polycarbonate. To remove it, place your thumbs on the top front face of the housing and your forefingers on the back face of the housing and gently unclip.

Remove the tube by turning a $\frac{1}{4}$ turn anti clockwise and sliding the fluorescent tube out from the brackets on either side. Replace with an equivalent T4 fluorescent tube. Slide the new tube into the fixing brackets and secure by turning a $\frac{1}{4}$ turn clockwise. Clip the light cover back into place. Plug in and restart the appliance

SAFETY AND SERVICING

THIS APPLIANCE MUST BE EARTHED

If this appliance is fitted with a non-rewirable plug for which your socket is unsuitable the plug should be cut off and an appropriate plug fitted. The removed plug must be disposed of as insertion of the plug into an electrical socket is likely to be dangerous.

ELECTRIC PLUG WIRING (UK ONLY)

The wires in the mains lead are coloured in accordance with the following code:

GREEN AND YELLOW - EARTH

BLUE - NEUTRAL

BROWN - LIVE

connect BLUE to
NEUTRAL (N)

connect GREEN &
YELLOW to EARTH (E)

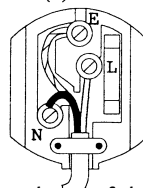

connect BROWN
to LIVE (L)

make sure the cable
is held by the clamp

As the colours of the wires in the mains lead of your appliance may not correspond with the coloured marking identifying the terminals in your plug, proceed as follows:

CONNECT GREEN & YELLOW coloured wire to plug terminal marked 'E' or earth symbol or coloured green or green and yellow.

CONNECT BLUE coloured wire to plug terminal marked 'N' or coloured black.

CONNECT BROWN coloured wire to plug terminal marked 'L' or coloured red.

If it is necessary to change the fuse in a moulded plug and the fuse cover is detachable, it must be refitted after the fuse has been changed. If the fuse cover is lost or damaged the plug must not be used until a replacement is obtained.

It is important that the colour of the replacement fuse cover corresponds with the

coloured insert or as indicated in embossed words on the base of the plug. Replacement fuse covers are available from the Spares Department, Lec Refrigeration plc. at the address on the rear cover of this leaflet.

If the plug supplied becomes damaged it must be replaced with a new one.

When a non-rewirable plug or a rewirable 13 Amp (BS 1363) plug is used it must be fitted with a 13 Amp ASTA approved (BS 1362) fuse. If any other type of plug is used it must be protected by a 15 Amp fuse either in the plug or at the distribution board.

RADIO INTERFERENCE: This appliance complies with current British and European Standards and CE Directives.

INTERNATIONAL VARIANTS

If the model code ends with "E" (e.g. PE107E instead of PE107) or ends with "TROP" (e.g. PE107TROP instead of PE107) the cabinet will have been built for the international market and will have a different plug fitted.

SAFETY NOTES

Ensure that the appliance is earthed.

Ensure that the appliance is disconnected from the mains supply before attempting to remove light covers (if fitted).

Ensure that the appliance is disconnected from the mains supply before cleaning internally or defrosting.

Do not store flammable or explosive substances in the appliance.

Do not store corrosive substances in or near to the appliance.

Do not allow unsupervised children to use this appliance.

Do not remove items from the freezer with wet hands, the low temperatures may cause 'freezer burn.'

Do not place fizzy drinks in the freezer compartment as the containers may burst.

DEFROSTING (PE, PG, WR and LR Models)

Your appliance has an automatic defrost system which requires no special operations on the part of the user. The defrost water will fall into the trough underneath the bottom edge of the cold plate and run down the drain into the plastic defrost water evaporation tray sitting on top of the compressor.



It is important that the drain does not become blocked. If the drain does become blocked, remove the lower shelf and clear the blockage with a piece of soft wire or plastic such as a pipe cleaner or straw. This is not possible on the PE107.

DEFROSTING (ISR Models Only)

The freezer compartment present in ISR models will require defrosting manually. This should be done at least twice a year, or when the layer of frost on the inside of the freezer compartment reaches a thickness of 5mm. A heavy frost deposit on the inside of the freezer compartment is undesirable because ice acts as a form of insulation and affects freezing performance.

As a temporary measure, unplug the appliance and scrape off the soft residue of surface frost with a wooden or plastic spatula. Collect the removed frost and throw it away. **DO NOT USE SHARP INSTRUMENTS SUCH AS KNIVES OR ARTIFICIAL HEAT SUCH AS HEAT GUNS TO REMOVE ICE AS YOU MAY DAMAGE THE APPLIANCE.** For a complete defrost, unplug the appliance, remove all items and transfer them to another freezer.

Remove any surface frost using a blunt scraper. Ensure that the drip tray provided is placed below the ice box in order to collect any remaining ice or water. Defrosting can be assisted by placing a bowl of hot water in your appliance and closing the door as far as possible.

When defrosting is complete, wipe away any standing water and clean the appliance with lukewarm water and a little detergent. Rinse with clean warm water. Wipe the freezer compartment dry, re-connect the appliance to the mains supply and switch on.

TEMPERATURE CONTROL

Your appliance is supplied with the latest specification of electronic temperature controller.



Storage temperatures for the various models are as follows:

Model Range PE/PG

Operating temperature range Between +2 °C and +8°C
Cold alarm limit +1°C
Warm alarm limit +9°C

Model Range WR

Operating temperature range Between +1°C and +5°C
Cold alarm limit 0°C
Warm alarm limit +6 °C

Model Range LR/ISR

Operating temperature range Between +2°C and +10°C
Cold alarm limit +1°C
Warm alarm limit +11°C
Freezer compartment ISR < -3°C

Checking Minimum and Maximum temperatures

For recording purposes, the controller on your appliance logs the minimum and maximum temperatures which have been reached since the last reset. We recommend that you record the minimum and maximum temperature twice daily. First thing in the morning – this will show overnight or “steady state” temperatures, and last thing before business closes – this will show “daytime” temperatures which include door openings.

To check the maximum temperature press button “t-hi” will appear on the display. Press and hold button again to display the maximum temperature value. Record this value. After releasing the button again, “t-lo” will appear on the display. Press and hold button again to display the minimum temperature. Record this value. If it is necessary to scroll back through press button

Once the minimum and maximum temperatures have been recorded, the logging function needs to be reset in order to allow new values to be stored. To do this proceed as above by pressing button so that “t-hi” is displayed. Press and hold button again to display the value. Keeping this button held, press button at the same time. Next release your fingers from both buttons and “t-lo” will appear on the display. Press and hold button again to display the value and press button at the same time. Now release your fingers from both buttons. The maximum and minimum temperatures have now been reset and new values will be stored. To revert back to normal temperature display press button or do not press any button for 30 seconds.

ALARMS

The Appliance is fitted with audio / visual safety alarms to indicate undesired fluctuations in temperature. PE/PG models also have a door alarm fitted to warn users if the door is accidentally left open. Upon activation of an alarm, an abbreviated symbol will flash on the screen along with an audible warning. Explanations are given below.

“Hi” - This symbol will flash and a buzzer will sound, if the internal air temperature inside the cabinet deviates above the warm alarm border for a period of longer than 15 minutes.

To silence the buzzer, press any button. “Hi” will continue to flash on the screen until the temperature falls back within range. If the alarm condition continues, the buzzer will sound for 20 seconds every 60 minutes.

“Lo” - This symbol will flash and a buzzer will sound, if the internal air temperature inside the cabinet deviates below the cold alarm border for a period of longer than 15 minutes.

To silence the buzzer, press any button. “Lo” will continue to flash on the screen until the temperature rises back within range. If the alarm condition continues, the buzzer will sound for 20 seconds every 60 minutes.

“Do” – This symbol will flash if the door is left open for longer than 1 minute. The audio alarm can be muted by pressing any button on the control panel. The controller will revert to normal once the door is closed.

REMOTE ALARM

On PE/PG1607 models the cabinet alarm can be connected to a remote control station via the two 4mm jack-plugs on the rear of the control panel. The appropriate connectors are supplied in the same bag as the user instructions. In the event of a high or low temperature alarm condition or power failure, a remote relay will switch within the controller to make an electrical circuit. On 1607 models the jack plugs are in a box at the rear of the cabinet in the unit housing.

Note! The contacts are supplied voltage free.

A voltage of between 12V DC and 230V AC can be connected at the contacts. The maximum load must not exceed 2A. The minimum power rating is 500mA / 12V AC.

This must be installed by a competent electrician.

In a normal condition (no alarm) the AUX relay OPENS the contact for the remote alarm facility.

When there is an alarm condition (Hi/Lo temperature, door alarm (where fitted), power failure or probe failure), the AUX relay CLOSES the contact.

TROUBLESHOOTING

» The appliance does not work at all

Check that the appliance is plugged in and that the power is on.

Check that the fuse in the plug is intact.

» The appliance is noisy

Check that the appliance is level.

Check that the appliance is not touching nearby items of furniture or other objects.

“Whooshing” and “gurgling” noises caused by the refrigeration system are perfectly normal and cannot be avoided.

» The appliance is not meeting the correct temperature

Check that the door is shutting and sealing correctly.

Check that the internal fan is working.

Check that the appliance is not too close to a heat source (such as a radiator).

Check that the appliance is not overloaded with products. The appliance requires space between stored items in order for the air to circulate correctly.

Check that there has not been a sudden rise or fall in room temperature. Your appliance is designed to operate in an ambient temperature between 16°C – 32°C. (18°C - 43°C for “TROP” models).

Check that the appliance is positioned correctly. It should be positioned away from direct sunlight. There should be a minimum of 50mm clearance around the sides, 25mm at the top and 75mm of clearance at the back to allow free circulation of air.

» The Internal light doesn't work (Glass door models only)

There may be a power supply problem. The bulb may need replacing (refer to the manual for further details)

If the ideas given above have not solved the problem, call service. Don't attempt repairs on your own, particularly on electrical components

AFTER SALES SERVICE

If service should be required please contact the supplier of the appliance. Give them the date of purchase, the model and serial number (found on the DATA PLATE inside the appliance) and state the nature of the fault.

DISPOSAL

If you are disposing of an old cabinet, break off any latches and hinges as a safeguard against small children trapping themselves inside.

The refrigerant used in your appliance and the insulation materials require special disposal procedures. Ensure that none of the pipes on the back of the appliance are damaged prior to disposal.

Up to date information concerning options for disposal can be obtained from your retailer or local council office.

NOTES

NOTES



Lec⁺

Glen Dimplex Professional Appliances
(A Division of Glen Dimplex Home Appliances)
Stoney Lane, Prescott, Merseyside L35 2XW
T: 0871 222 51 18
F: 0871 222 96 93
E: info@gdpa.co.uk www.lec-medical.co.uk

I 2023-7 Medical Users Guide March 2008
© Copyright Glen Dimplex Professional Appliances 2007

