

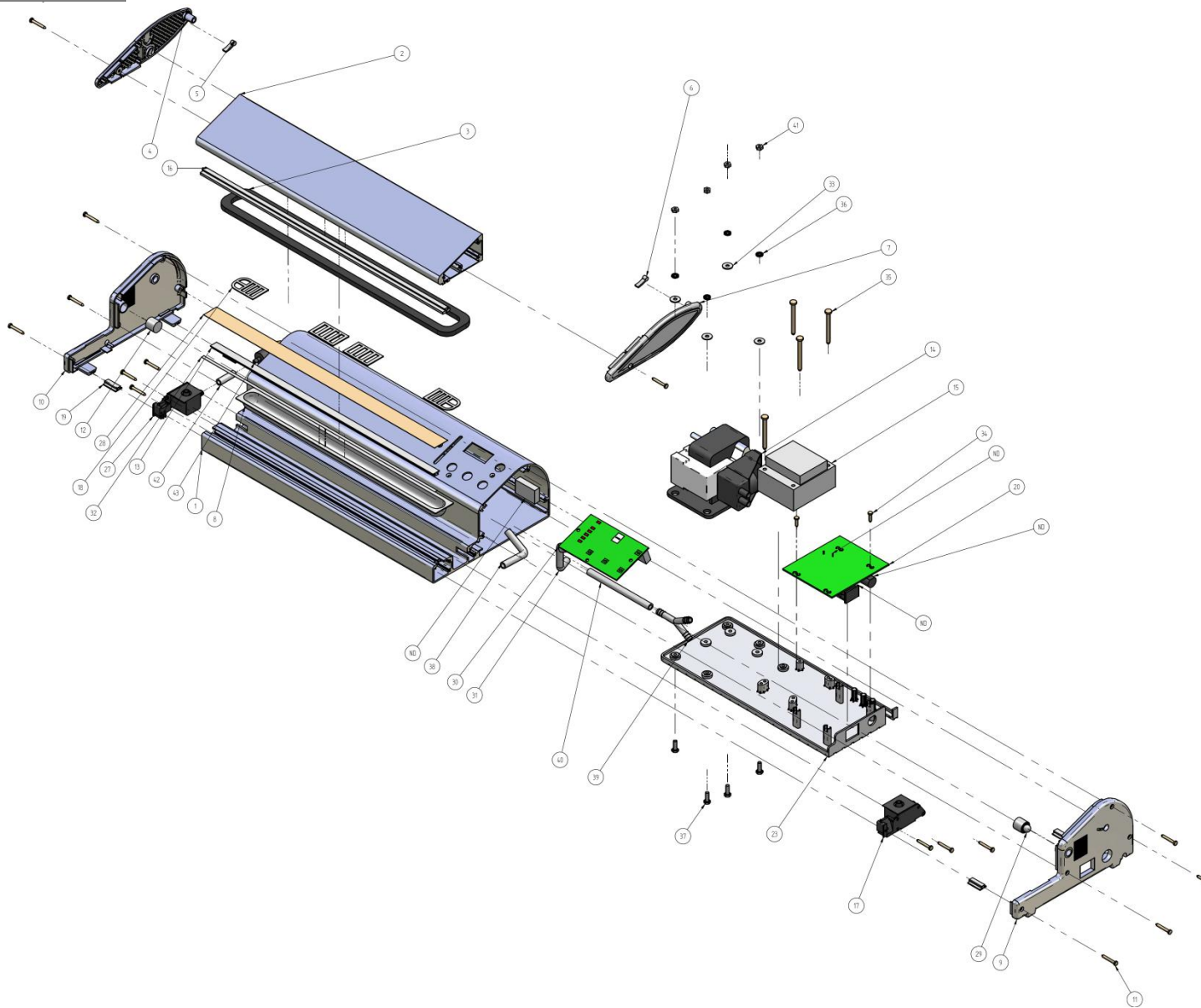









Exploded diagram and spare parts list

CC771



Machine	Explode	Code	Description
CC771 Buffalo Professional Vacuum Pack	1	AD638	Outer casing
CC771 Buffalo Professional Vacuum Pack	2	AD640	Sealing bar casing
CC771 Buffalo Professional Vacuum Pack	3	AD642	Sealing bar rubber gasket
CC771 Buffalo Professional Vacuum Pack	4	AD643	Sealing bar end cap lh
CC771 Buffalo Professional Vacuum Pack	5	AD645	Sealing bar ms operating lever lh
CC771 Buffalo Professional Vacuum Pack	6	AD646	Sealing bar ms operating lever rh
CC771 Buffalo Professional Vacuum Pack	7	AD644	Sealing bar end cap rh
CC771 Buffalo Professional Vacuum Pack	8	AD648	Drip tray
CC771 Buffalo Professional Vacuum Pack	9	AD649	Body casing end cap rh
CC771 Buffalo Professional Vacuum Pack	10	AD650	Body casing end cap lh
CC771 Buffalo Professional Vacuum Pack	11		Screw
CC771 Buffalo Professional Vacuum Pack	12		Cap
CC771 Buffalo Professional Vacuum Pack	13	AD652	Heat sealing bar rubber
CC771 Buffalo Professional Vacuum Pack	14	AD654	Vacuum pump
CC771 Buffalo Professional Vacuum Pack	15	AD656	Voltage transformer
CC771 Buffalo Professional Vacuum Pack	16	AD658	Heat sealing bar casing rubber strip
CC771 Buffalo Professional Vacuum Pack	17	AD659	Suction tube cap lh
CC771 Buffalo Professional Vacuum Pack	18	AD660	Sealing bar end spacer
CC771 Buffalo Professional Vacuum Pack	19	AD661	Rubber foot
CC771 Buffalo Professional Vacuum Pack	20	AD662	Main operating PCB tube
CC771 Buffalo Professional Vacuum Pack	23	AD663	Bracket
CC771 Buffalo Professional Vacuum Pack	27	AD664	Suction tube cap lh
CC771 Buffalo Professional Vacuum Pack	28	AD671	Teflon sealing tape
CC771 Buffalo Professional Vacuum Pack	29	AD669	Stainless steel ball
CC771 Buffalo Professional Vacuum Pack	30	AD670	Control panel PCB assembly
CC771 Buffalo Professional Vacuum Pack	31	AD665	Tube exhaust
CC771 Buffalo Professional Vacuum Pack	32	AD672	Resistance wire
CC771 Buffalo Professional Vacuum Pack	33		Washer
CC771 Buffalo Professional Vacuum Pack	34		Screw
CC771 Buffalo Professional Vacuum Pack	35		Screw
CC771 Buffalo Professional Vacuum Pack	36		Crimped washer
CC771 Buffalo Professional Vacuum Pack	37		Screw
CC771 Buffalo Professional Vacuum Pack	38	AD666	Drainage tube
CC771 Buffalo Professional Vacuum Pack	39		Y-shaped connector
CC771 Buffalo Professional Vacuum Pack	40	AD667	Suction tube
CC771 Buffalo Professional Vacuum Pack	41		Nut
CC771 Buffalo Professional Vacuum Pack	42	AD668	Linking tube
CC771 Buffalo Professional Vacuum Pack	43	AD673	Air vent